

NUMERICAL CONTROL (CNC)  
M700V Series

M700V  
series



**The Best Partner for Your Success**

# Mitsubishi CNC M700V Series

## The best machines for top level manufacturing

The one and only. Only top level manufacturing can survive.

Mitsubishi CNC M700V Series is a state-of-the-art model that provides high-speed and high-accuracy machining and advanced control technologies. These Functions are for customers who keep challenging for more production output, with a worldwide recognized machine for today's globalized industry.

M700VS Series is an integrated control unit and display type.

M700VW Series also comes with Windows®XP.

These two types of Mitsubishi CNC M700V Series support top level manufacturing.

The Best Partner for Your Success

# MITSUBISHI CNC

# M700V

series



### [Complete NANO]

Controls everything from the CNC's operation to servo processing with a least command increment of 1nm



### [5-axis, multi-axis]

Controlling multiple axes allows the positioning of the tool center point



### [High-speed, high-accuracy]

High-quality machining by determining appropriate shapes and avoiding unnecessary deceleration



### [Easy operation]

Simple programming system for machining center and lathe



### [High-speed, high-accuracy]

High-speed and high-accuracy control of the drive system is achieved by estimating program paths from beginning to end



### [Customize]

Tools used in developing solutions for control customization

M700VS and M700VW Series, advanced Mitsubishi CNCs for next-generation machining

# Lineup

[System Configurations & Product Lines]

# M700V series



Mitsubishi CNC  
M700V Series  
M700S Series

**M700V Series**

**M700S Series**

## Drive Unit



Multi-hybrid drive unit  
| MDS-DM2 Series



High-performance drive unit  
| MDS-D2/DH2 Series



Ultra-compact drive unit with built-in power supply  
| MDS-DJ Series

## Servo Motor



Medium-inertia motor  
| HF Series



Low-inertia motor  
| HF-KP Series

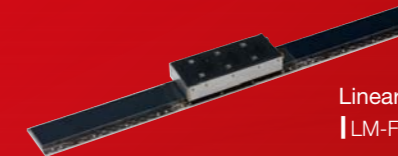

Linear servo motor  
| LM-F Series

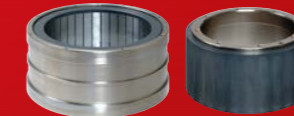

Direct drive servo motor  
| TM-RB Series



Rotary detector  
| MBA Series

## MELSOFT (Tools)



Personal computer+Windows®



- NC Designer
- NC Monitor
- NC Explorer
- NC Trainer
- NC Trainer plus
- NC Analyzer
- NC Configurator2
- GX Developer
- NC Maintainer
- etc.

## Machine Operation Panel



## Spindle Motor



High-performance spindle motor  
| SJ-D Series  
| SJ-V Series



Low-inertia and high-speed spindle motor  
| SJ-DL Series  
| SJ-VL Series



Built-in spindle motor  
| SJ-BG Series  
| SJ-B Series



Tool spindle motor  
| HF-KP Series  
| HF-SP Series



Detector for C axis  
| MBE Series

From drive units to servo/spindle motors —————  
Advanced CNC components for higher performance

# Technologies

## Basic Performance and Functions

For higher speed and higher accuracy  
Bringing the complete nano world closer to you

Mitsubishi Electric Factory Automation technologies are condensed into a 64 bit RISC processor and an exclusively developed high speed LSI. The basic CNC functions, built-in PLC and graphic performance are all improved. The M700VS has been downsized with power consumption reduced by 66% compared to our conventional Windows-based control models while maintaining the same performance. Windows®XPe-based M700VW was designed with expandability and stability to enable a higher level of custom functions.

### Machining Program Processing Speed



(Note 1) BPM is the number of machining program blocks processed per minute.  
(Note 2) M700VS's machining program processing speed is 67.5kBPM.

### User Macro Processing Performance



### Built-in PLC Basic Instruction Processing Performance



# M700V series

## Complete Nano Control



All operations from program values to servo commands are done in nanometer units. Interpolation is at the nano-unit level even when program commands are in micrometer units.

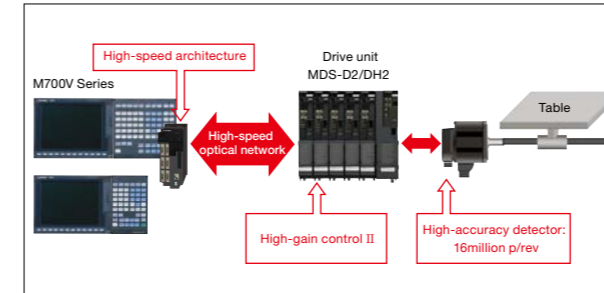

### Speed command fluctuation reduced

In complete nano control, the position command calculation fraction of the interpolation calculation is small, so fluctuations in speed command due to the fractions is reduced. This reduces acceleration fluctuations, resulting in finer lines at the time of repeated acceleration/deceleration.

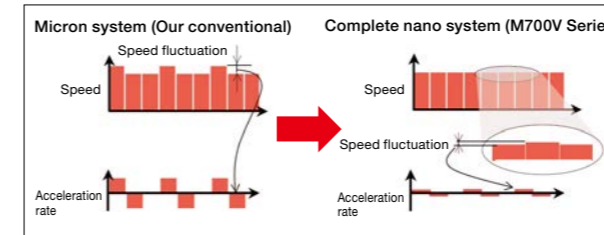

### Interpolation calculation accuracy improved

Even with one-micron-unit commands in the machining program, interpolation is in nanometer units. As the calculation accuracy of a block intersection is improved, lines on the surface is finer.

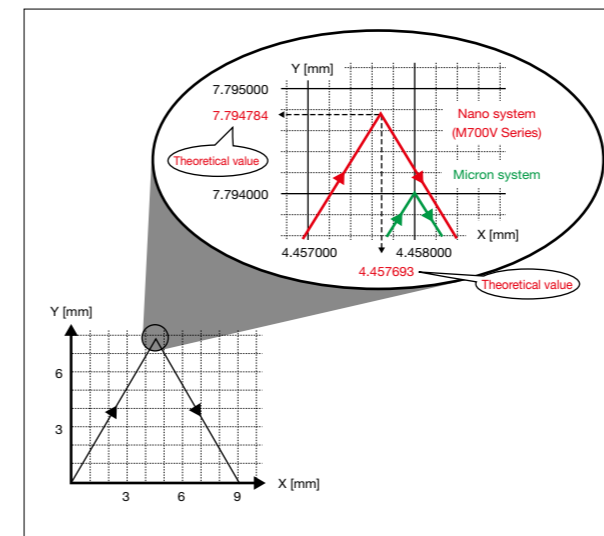

## PLC Axis

### Indexing function

By setting the number of stations required for the application, the drive automatically sets up equal intervals between each station. Positioning of the axis is only possible by commanding the station number.

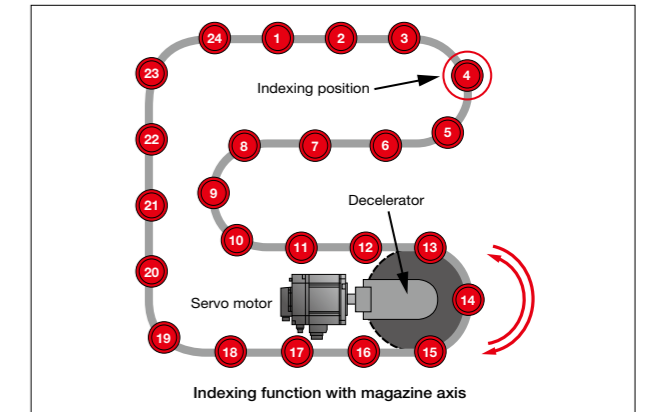

### PLC axis mixed control

Even if a pallet is changed, the axis can always be controlled as an NC axis in the machining area, and as a PLC axis in the setup area, which enables setup of a rotary axis without stopping machining.

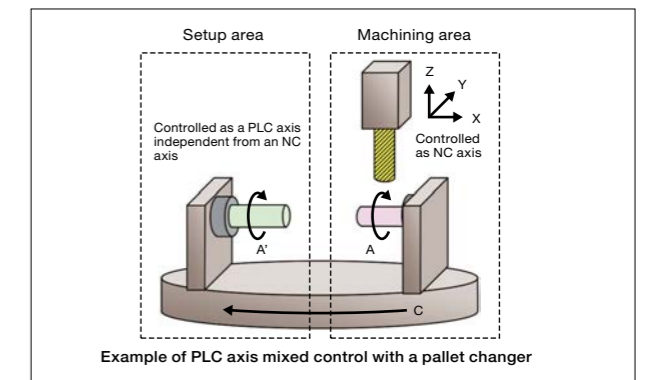

## Index Modification Function of PLC Instructions

- The index modification function is available, which is one of MELSEC's wide variety of instructions.
- Repetitive programs can be written easily.

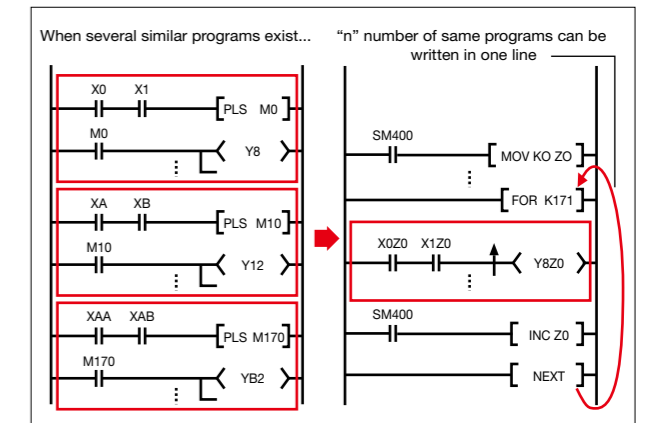

# Technologies

## Supporting Machine Tool Accuracy Improvement

Calculated control (OMR control) of the drive system based on the machine model realizes optimum machine operation

### OMR-DD Control (High-speed synchronous tapping)

Optimum Machine Response Direct Drive



A high-speed error-compensation function is used for controlling the spindle and servo, enabling accurate tapping.

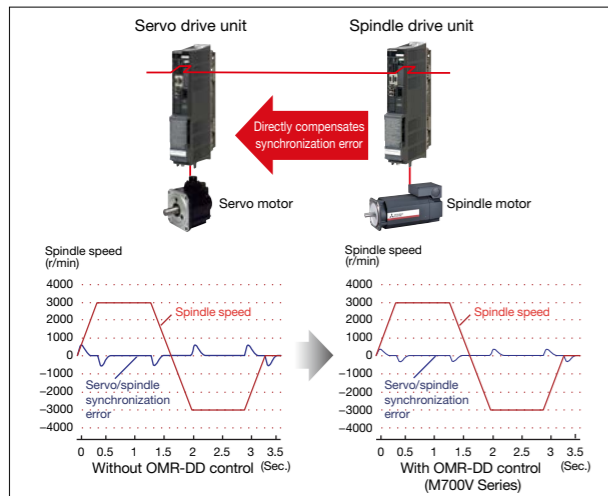

### Machine-end Compensation Control

#### Corresponds to machine resonance fluctuations

By compensating for the deflection between the motor-end and machine-end, the part shape at a high speed and acceleration rate can be compensated for. The optimal shape can be obtained at a low feed rate and also compensate for the outward expansion of the shape at high feed rates.

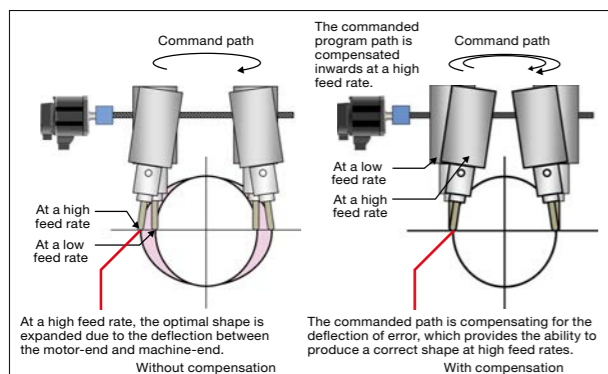

### Adaptive Notch Filter

This function is used to estimate the resonance frequency of the machine and automatically adjust notch filter parameters. This enables the system to monitor the machine fluctuations and prevents repeated fluctuations caused by aged deterioration.

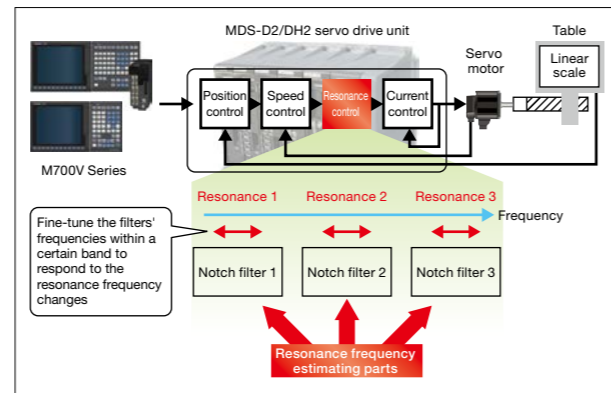

### Lost Motion Compensation Control Type 3

This control can compensate for not only the machine friction but also the spring and viscosity elements. Thus quadrant protrusions, which are generated in circular cutting, can be compensated for within a wide range from low-speed to high-speed cutting.

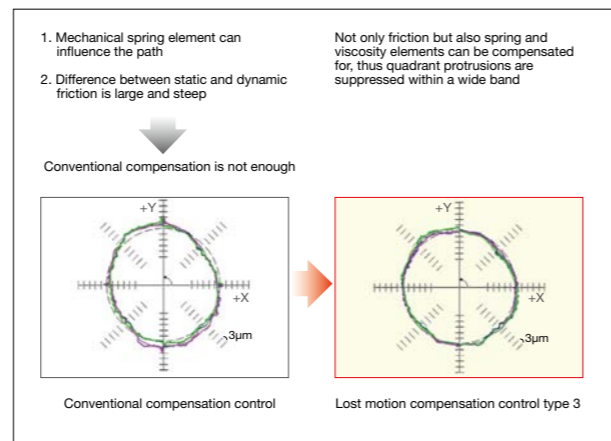

### Position-dependent Gradually Increasing-type Backlash Compensation

Protrusion is reduced by gradually changing the backlash compensation amount according to the reversal of axis travel direction, which enables higher-accuracy machining.

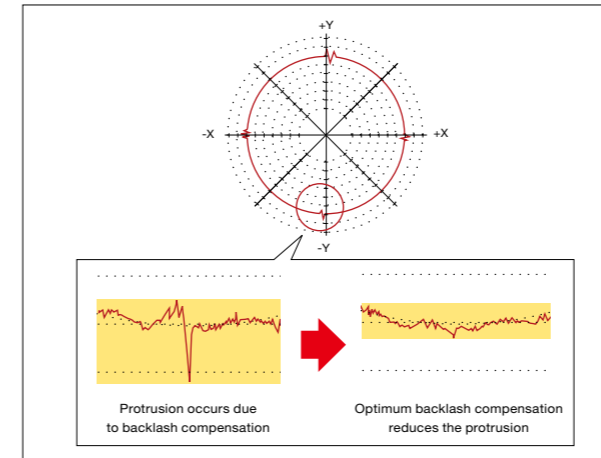

### Position Loop of Spindle Control

High traceability to command (High-gain control II), which has been developed in servo axis control, is now available on spindles, contributes to shorter machining time and higher accuracy.

#### Spindle/C-axis control

The spindle's constant position loop control has eliminated the zero point return time when switching from the spindle to C-axis.

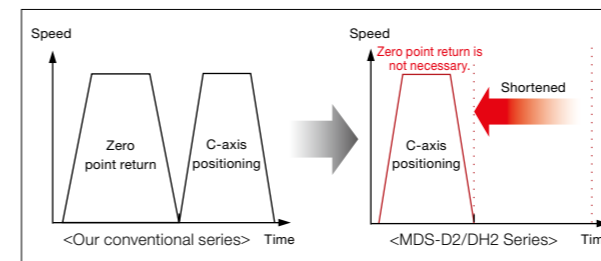

#### Orientation time is reduced

Deceleration is performed with the maximum torque to minimize the spindle orientation time.

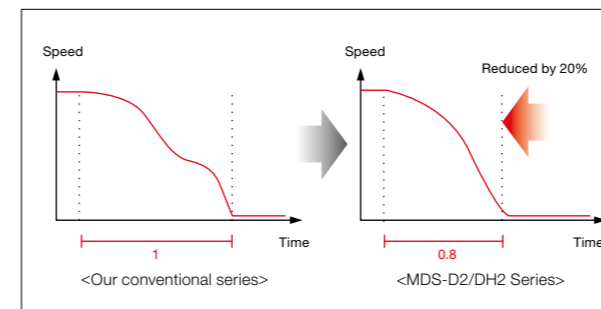

#### Heavy cutting performance improved

Heavy cutting performance has been improved with the addition of position loop control on the spindle. By lowering the impact load fluctuation, the speed fluctuation rate has been reduced to less than 1/2 of our conventional system.

# M700V series

### Two-way Pitch Error Compensation

The pitch error compensation function has been improved. By setting the compensation amounts separately for the positive and negative directions, different compensation can be applied to each direction.

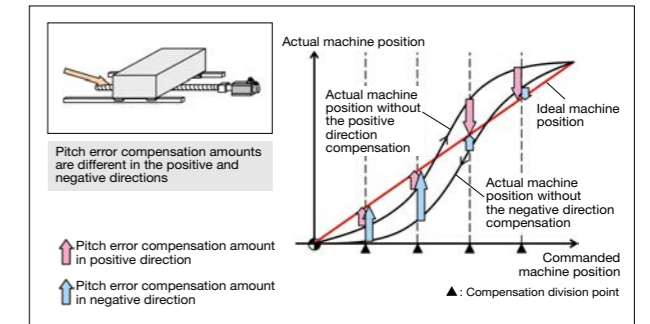

### Lowering Heat Generation of Spindle Motors

Reduced harmonic current mitigates heat generation in the spindle motor.

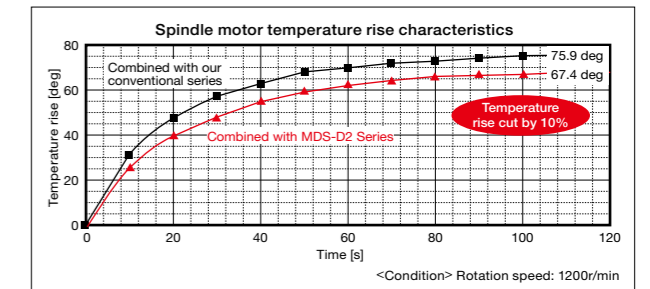

### Automatic Temperature Compensation of Spindle Motor

A built-in thermistor detects the spindle motor's temperature to compensate for the acceleration/deceleration time when the motor is at a low temperature. It is also possible to monitor the spindle motor's temperature on the NC screen.

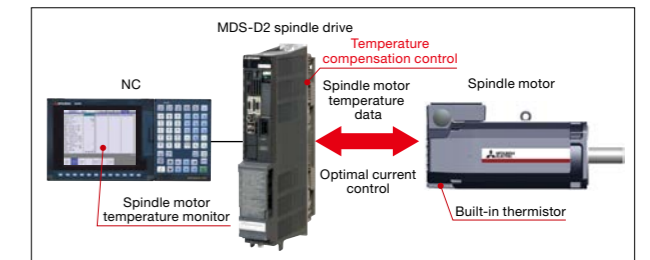

#### Spindle acceleration/deceleration time shortened

The change of accel/decel characteristics due to motor temperature changes can be suppressed, which allows the system to be controlled at a constant accel/decel rate.

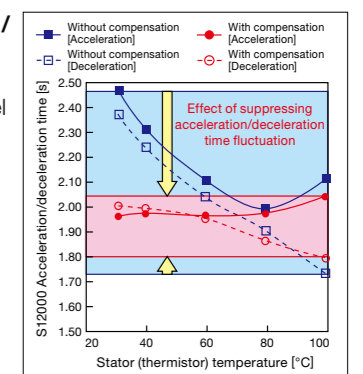

# Technologies

M700V series

Human Machine Interface provides for better visibility and operator ease of use

Easy-to-use interface with useful functions



(HMI:Human Machine Interface)

## HMI for Easier and More Visible Use

### Screen structure linking to the operation processes

Operation processes are divided into three steps, "Monitor", "Setup" and "Edit", and necessary information is aggregated into three screens. These screens can be displayed by touching a single button on the keyboard.

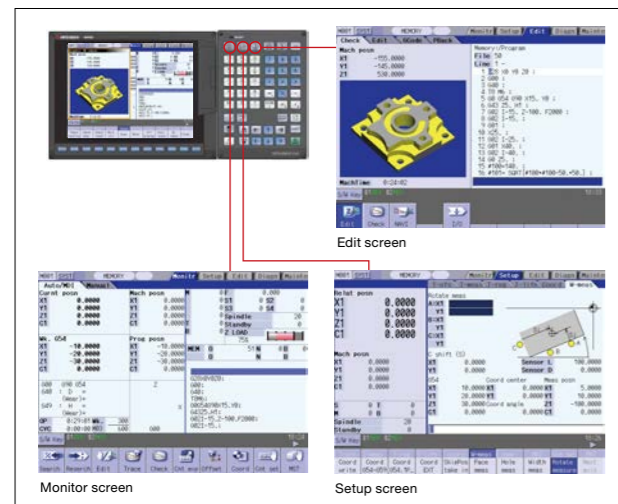

### 2-part system display

The Monitor screen of the 2nd part system can be displayed together with the 1st part system. Switching screens is not necessary.

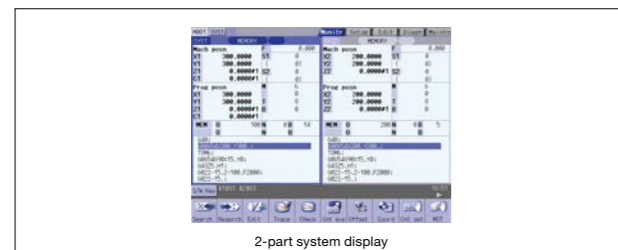

### Pop-up screens

Tabs allow the user to select necessary operations from the operation menu, and pop-up screens allow the user to access desired information while the original screen remains displayed. For displays with a touch panel, a keyboard can be displayed on the screen.

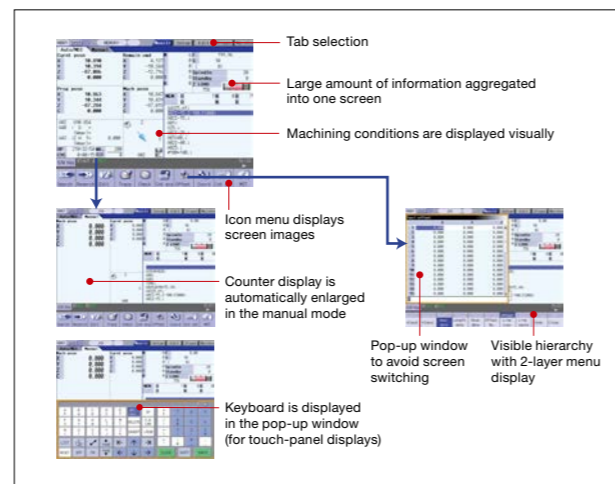

### Menu customization function

Menu keys on the bottom of the screen can be freely arranged. Frequently used menu keys can be put together on the first page.

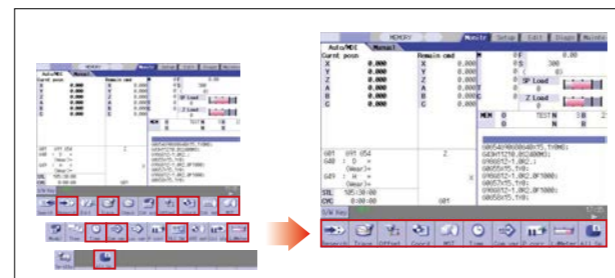

## Operation Support

### Manual/Automatic backup function

- Batch-backup of the NC data into the memory card/USB memory inserted in the front interface of the display is possible. For the built-in hard disk type M700VW Series, backup in the hard disk is also possible.
- Data is automatically backed-up at a certain interval set by the parameter.

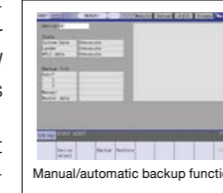

### Operability of operation search improved

Using the program edit screen, it is possible to execute a program from the line specified by the cursor. The operation search immediately detects the edited part to check the content of operation.

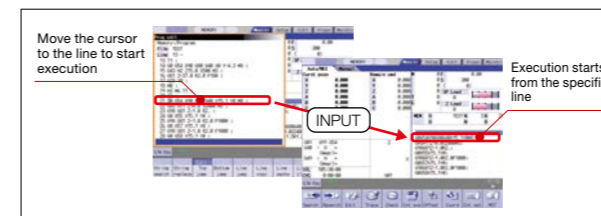

### Guidance function

By pressing the help button, guidance (operation procedure /parameter descriptions/alarm descriptions/G code format) regarding the currently displayed screen will be shown.

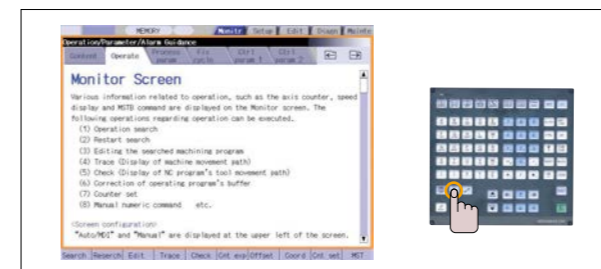

## NAVI MILL (for machining center)/ NAVI LATHE (for lathe)



### Simple programming function

- Programs are automatically created for each process when an operator selects machining process and inputs data on screen. A tool path can be graphically drawn for the program check.
- This function also supports in-tilted surface machining.

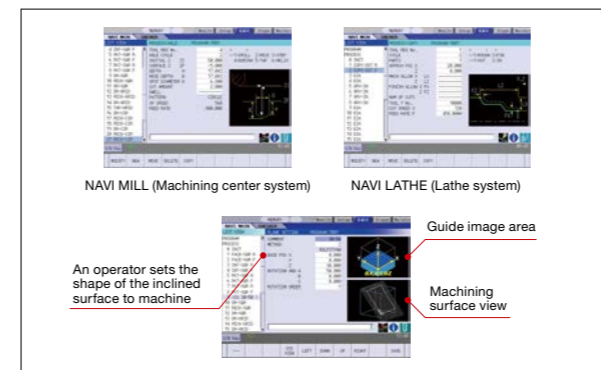

### Program input error warning function

- The added 3D solid model check function allows more realistic cutting check.\*
- This function helps an operator to input and check programs. Errors are indicated when a decimal point is omitted.

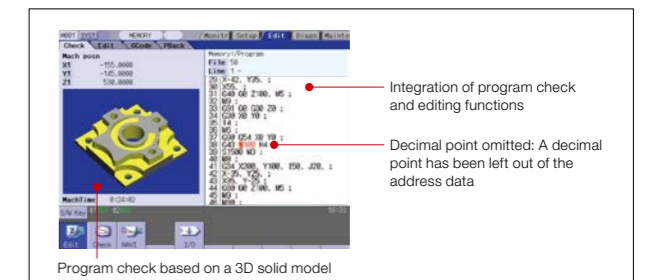

\*Available with M700V Series (M System) only.

### Operability of program restart function improved

Even if a machining program is stopped for reasons such as tool breakage, the program can be restarted when it has been stopped using only the INPUT operation.

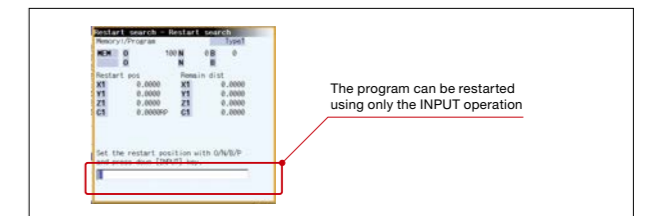

### Menu list

Menu list buttons are newly introduced. With these buttons, the screen desired for display can be called up directly. The selected screen's function outline is also displayed.

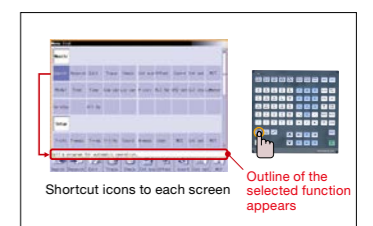

## Program Operation

- Machining programs in the memory card or in the hard disk (for M700VW Series) can be directly searched and run. Direct edit is also available.
- Sub-program call is available from machining programs stored in the memory card or hard disk.
- The program format is unlimited.

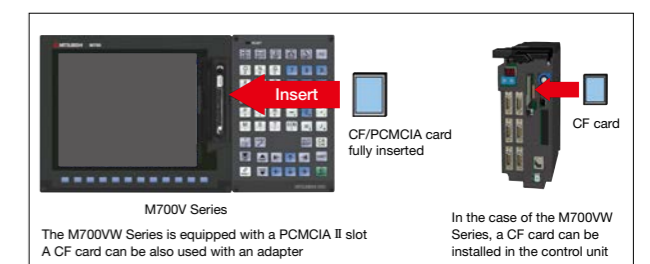

# Technologies

For High Quality machining with smoother finish and faster performance

Five-Axis Machining functions such as Tool Center Point and SSS control have been enhanced.

With the enhancement of these functions, five-axis control will provide high-end performance.

The advanced five-axis control provides great potentialities.

## SSS Control (Machining Center System)

Super Smooth Surface



- By judging part program paths, unnecessary deceleration is reduced, even when fine steps in the program exist. This provides a smooth finish without deviation for die-mold machining.

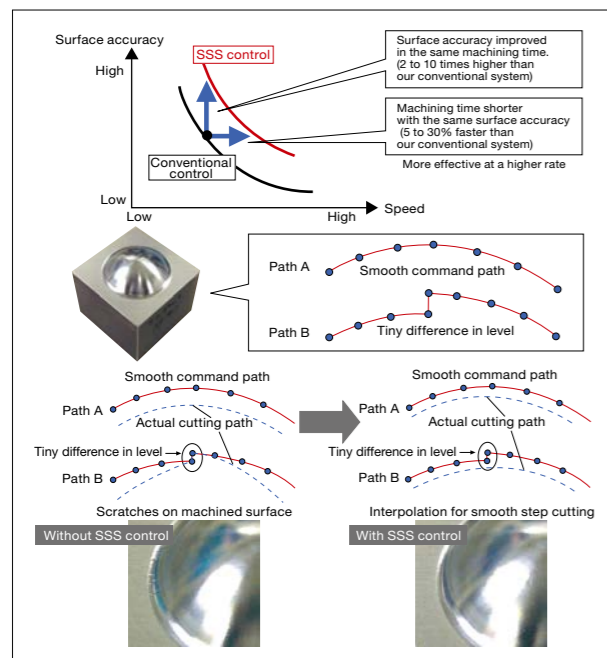

- This function suppresses the vibrations of the tool by moving the rotary axis smoothly. Even when this function is active, the Tool Center Point path moves according to the command program path.
- SSS control can be used during simultaneous five-axis machining.

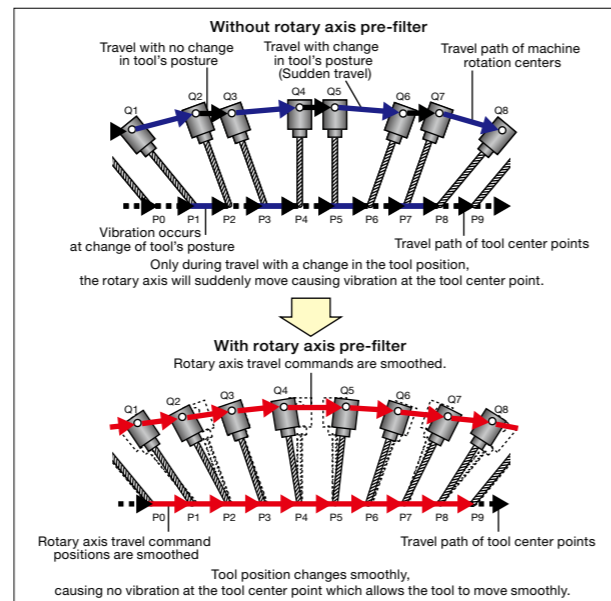

## R-Navi (Machining Center System)

- Provides easy setup of index machining (multiple/inclined surface machining) using a rotary axis.
- Enables secure, easy and smooth setup and index machining

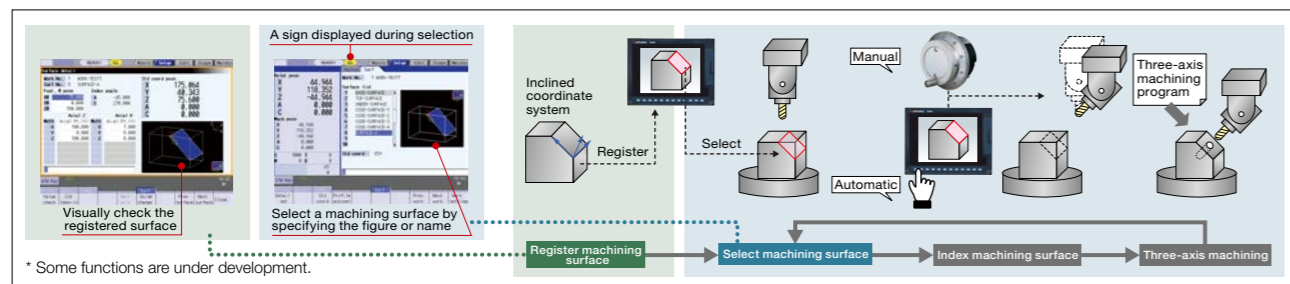

\* Some functions are under development.

# M700V series

## Tool Center Point Control (Machining Center System)



\*M750VS, M750VW only

High-accuracy machining is realized by controlling each axis so that the tool center point moves linearly at a commanded feed rate even if the rotary axis moves in linear interpolation.

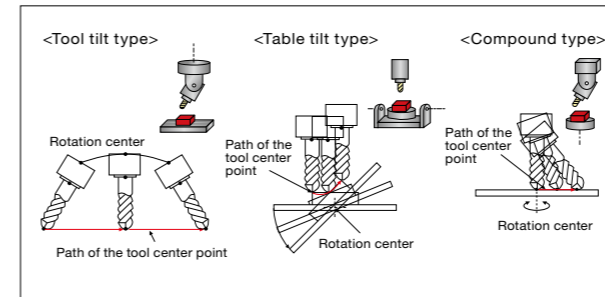

## Tool Handle Feed & Interruption (Machining Center System)



\*M730VS, M730VW, M750VS, M750VW only

The Tool Handle Feed & Interruption function enables you to perform handle feed by making the tool diameter direction as an X or Y axis of complicated workpiece under five-axis machining. The tool position can be changed without moving the tool tip.

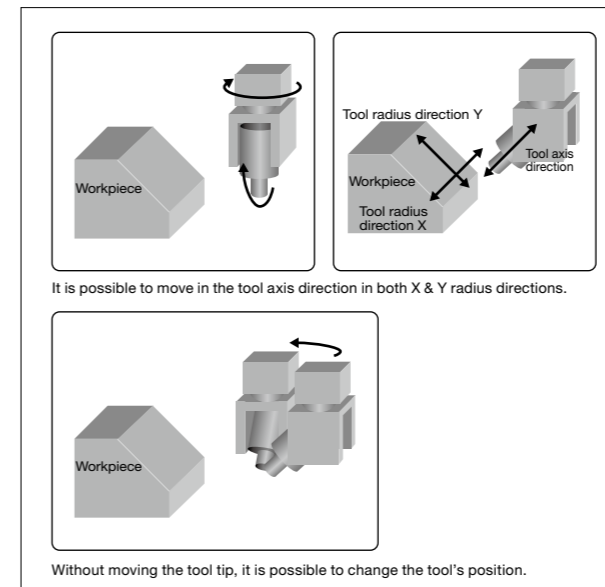

## OMR-FF Control Optimum Feed Forward



Unlike conventional control, which simply matches the motor path to the commands, OMR control calculates the machine's status based on a model and applies correction to motor control in order to match not the motor position, but the machine tool position to the commands.

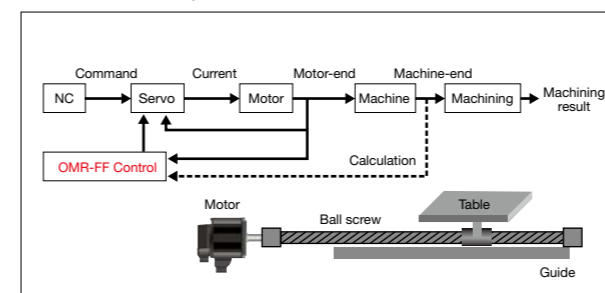

## Inclined Surface Machining (Machining Center System)



You can rotate or move the origin of the original coordinate system parallel to define a feature coordinate system. To start machining, issue normal program commands to the arbitrary plane (inclined surface) in space. The feature coordinate system is set again according to the tool axis's direction. The machining program can be created without paying attention to the direction of the coordinate system or tool axis rotational direction.

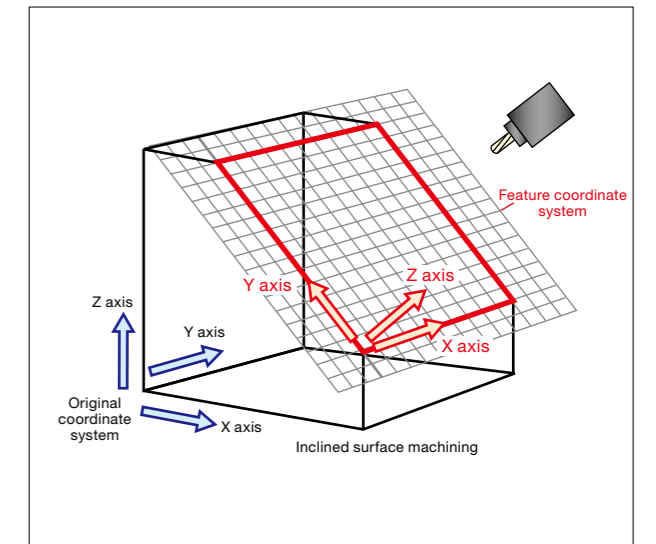

## 3D Machine Interference Check

\*M730VW, M750VW only

- This function prevents interference on a machine model (in both manual and automatic operations) before it actually happens in the machine.
- The part to interfere can be checked by moving, rotating or enlarging the models.
- Interference can be prevented for a tilt-type tool axis and rotating table. (Useful when soft limit is not enough to prevent interference)

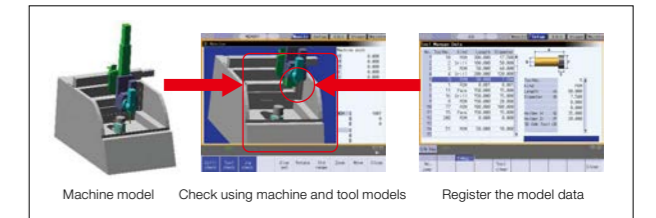

## Example of detecting a tool interference while a tilt type tool is rotating

When a possibility of interference is detected on a machine model, the motor decelerates to a stop before interfering. The part to interfere is displayed in a different color.

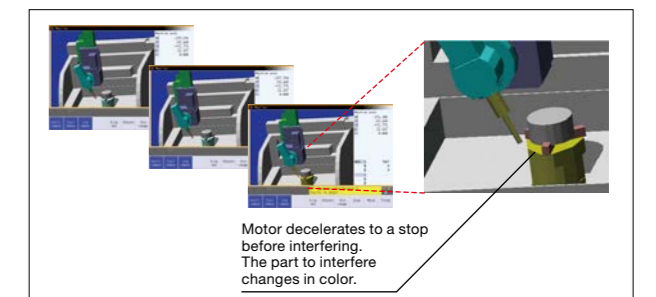

# Technologies

## Various Functions for Compound Machining

Supports various compound machining applications, from multi-part system program paths for multi-axis machining centers to multi-axis milling and hobbing.

### Multi-part Systems Multi-axis

A maximum of two part systems and 16 axes can be controlled for the machining center. A maximum of four part systems and 16 axes can be controlled for the lathe. (A maximum of two part systems and 12 axes for M720VS, M720VW)

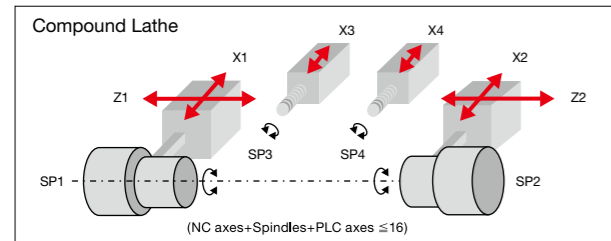
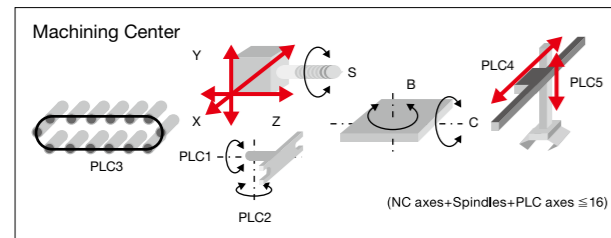

### Control Axis Synchronization Across Part Systems (Lathe System)

Synchronization control enables an arbitrary control axis in the other part system to move in synchronization with the movement command assigned to an arbitrary control axis.

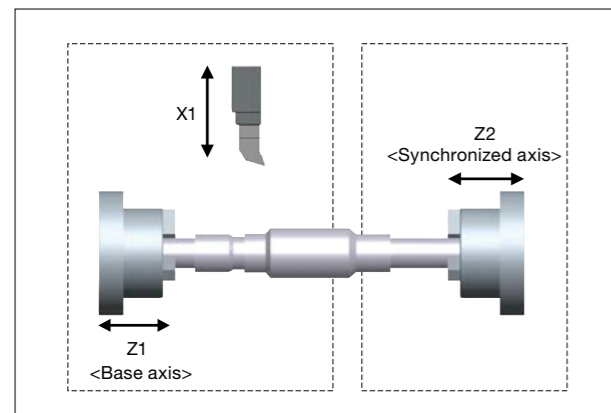

### Multi-part System Program Management

Separate programs, used in each part system, can be managed under a common name in the multi-part system. This function facilitates management of the process programs that are simultaneously executed in the multi-part systems.

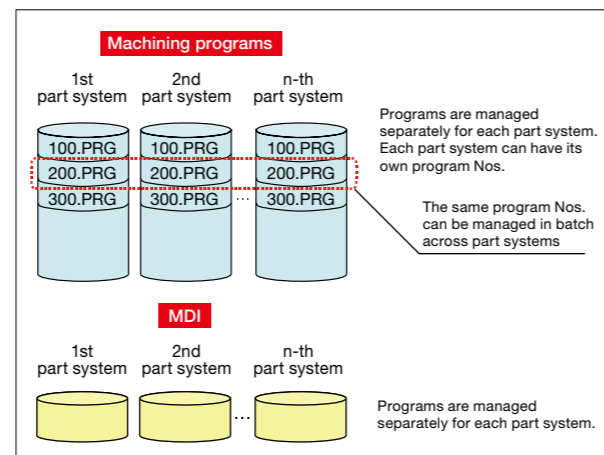

### Control Axis Superimposition (Lathe System)

- This function enables machining using a certain part system simultaneously with that of another part system by superimposing their movements.
- This is effective when machining in multiple part systems is executed simultaneously. It allows for an axis to shift its coordinate system relative to the system using the axis.

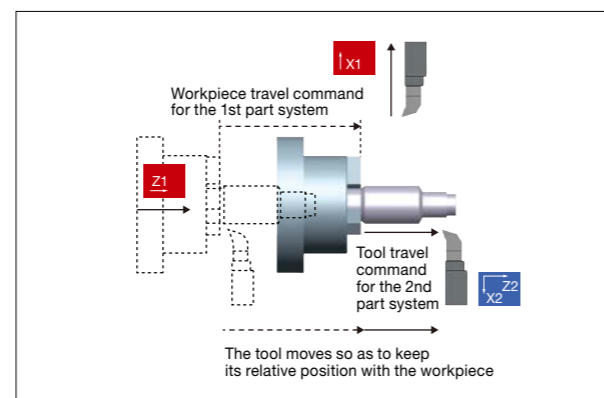

### Milling Interpolation (Lathe System)

This function converts the commands programmed for the orthogonal coordinate axes into linear axis movements (tool movements) and rotary axis movements (workpiece rotation) to control the contours. This enables milling operations using a lathe without a Y axis.

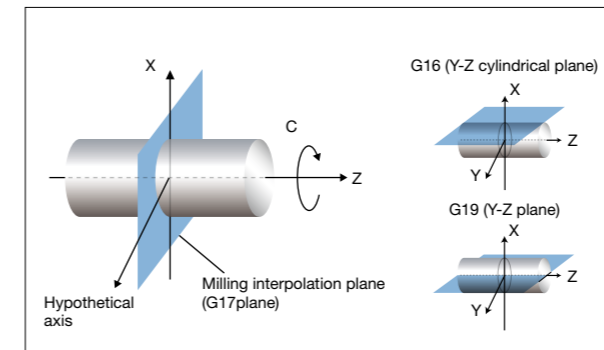

### Balance Cut (Lathe System)

- Deflection can be minimized by holding tools simultaneously from both sides of the workpiece and using them in synchronization to machine the workpiece (balance cutting).
- The machining time can be reduced by machining with two tools.

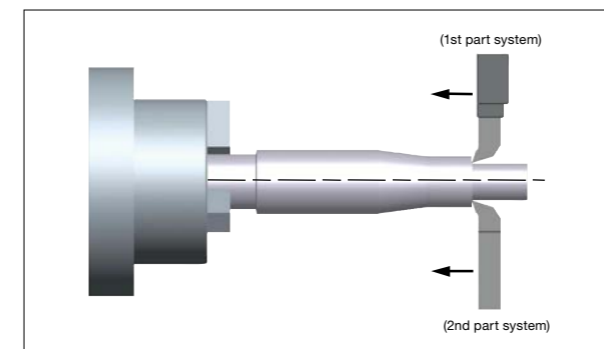

### Hobbing (Lathe System)

- G code format is available for hobbing.
- A spur gear can be machined by synchronously rotating the hob axis and the workpiece axis in a constant ratio. A helical gear can be machined by compensating the workpiece axis according to the gear torsion angle for the Z axis movement.

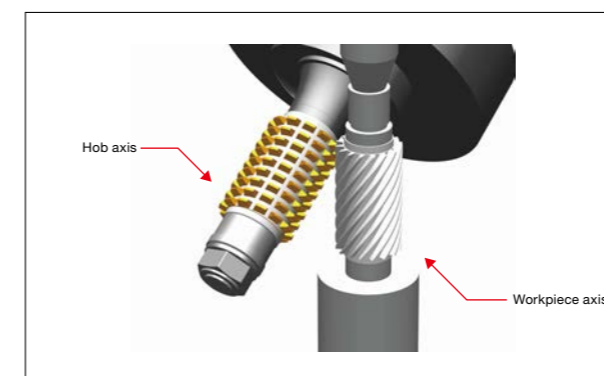

### 2-part System Synchronous Thread Cutting (Lathe System)

- 2-part system synchronous thread cutting allows the 1st part system and the 2nd part system to perform thread cutting simultaneously for the same spindle.
- 2-part system synchronous thread cutting has two commands; command (G76.1) for cutting threads in two places simultaneously, which is known as "2-part system synchronous thread cutting cycle I"; and command (G76.2) for cutting a thread using the two part systems simultaneously, which is known as "2-part system synchronous thread cutting cycle II".

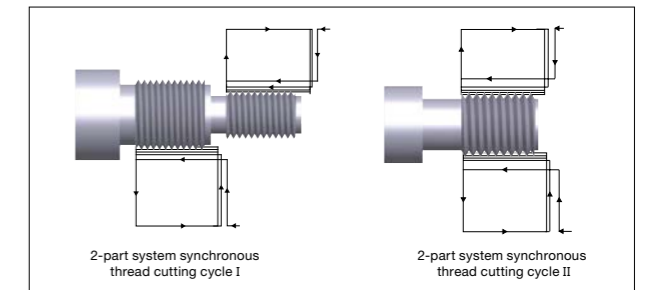

### Guide Bushing Spindle Synchronization Control (Lathe System)

This function is for a machine with a spindle motor to rotate a guide bushing: This function allows the guide bushing spindle motor (G/B spindle) to synchronize with a reference spindle motor (Reference spindle). The position error compensation function reduces the spindle's vibration due to the workpiece's torsion, and the motor's overload.

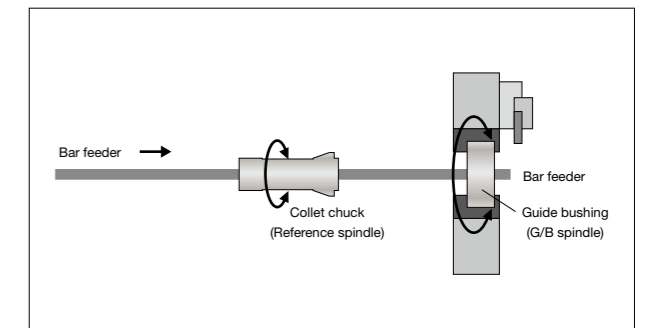

### Mixed Control (cross axis control) (Lathe System)

The control axes of each part system can be exchanged using a program command. This enables the axis defined as the axis of the 1st part system to be operated as the axis of the 2nd part system.

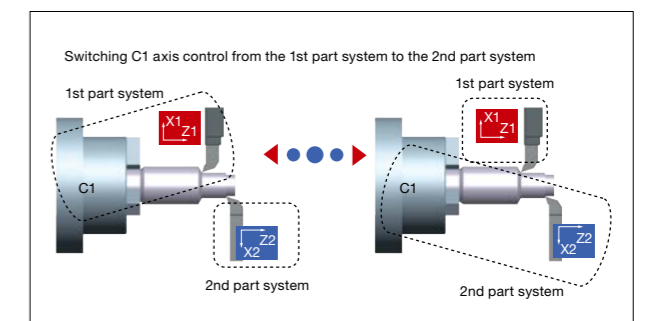



# Solution

## Customization/Support Tool

NC Designer and other Software Applications tools are available to support the customization of the machine. Some software applications support a C Language Library to support a higher level of customization.

### NC Designer (Screen Design Tool)



- By laying out ready-made standard parts, you can easily create original screens without programming.
- When using touch panel display, a machine operation panel can be built on the NC display.
- Events of the standard parts can be described using macros.
- Using the C language source generation function of NC Designer, customized functions can be added by programming in C language. (Dedicated development environment necessary.)

- Simply by locating parts of various functions on the screen, it is possible to create custom screens easily.
- It is possible to check the performance of custom screens on a personal computer.

#### Develop screen configuration

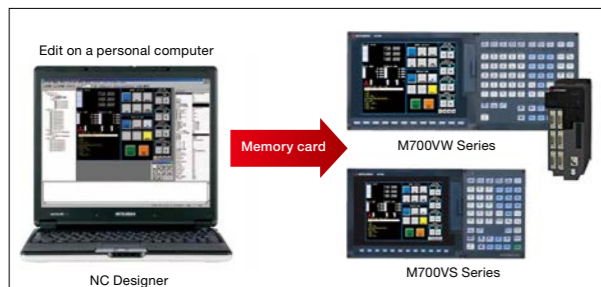
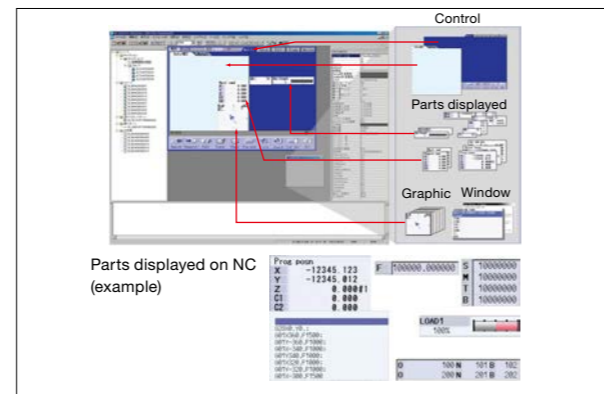

### GX Developer (Sequence Programming Tool)

The MELSEC programming tool, offering a wide array of functions and easy use, allows for convenient program design and debugging. Linking with a simulator or other utility allows for the efficient creation of desired programs.

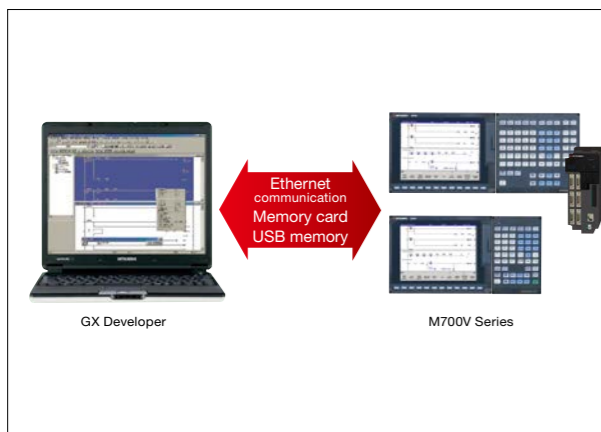

### NC Maintainer

\*M700VW only

A software tool for a personal computer to carry out maintenance (such as parameter setting, NC diagnosis and PLC program diagnosis) of MITSUBISHI CNC on customer's display.

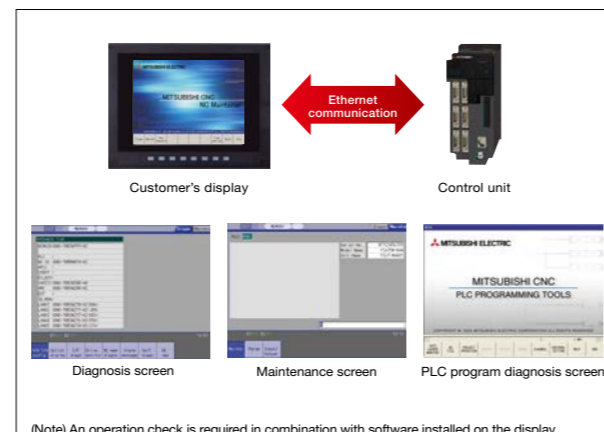

(Note) An operation check is required in combination with software installed on the display.

### Servo Selection Tool

By selecting the machine configuration model and inputting the machine specifications, the optimal servo motor meeting specifications can be selected. Other selection functions which fully support drive system selection are also available. This tool is free of charge. Please contact us.

<Main functions>

Servo motor capacity selection, regenerative resistor capacity selection, spindle acceleration/deceleration time calculation, power supply capacity selection, power supply facility capacity calculation, etc.

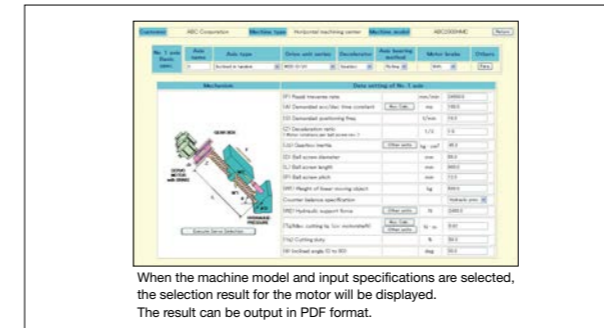

When the machine model and input specifications are selected, the selection result for the motor will be displayed. The result can be output in PDF format.

### NC Configurator2 (Parameter Setup Support Tool)

The NC data file necessary for NC control and machine operation (such as parameters, tool data and common variables) can be edited on a personal computer. Please contact us to purchase a full function version. (A limited function version is also available free of charge.)

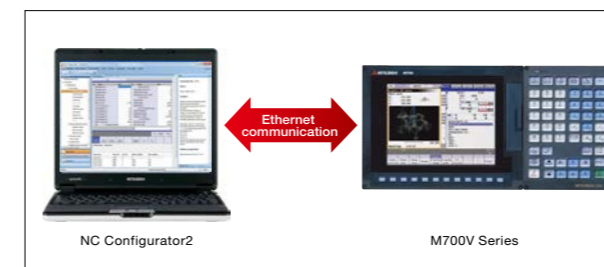

### NC Trainer / NC Trainer plus (MITSUBISHI CNC Training Tool)

- NC Trainer is an application for operating the screens of MITSUBISHI CNC M700V Series and machining programs. This application can be used for learning operating CNC and checking the operations of the machining programs.
- NC Trainer plus can also be used for checking the PLC program and custom screens.



### NC Analyzer (Servo Adjustment Support Tool)

Servo parameters can be automatically adjusted by activating the motor using machining programs for adjustment or vibration signals, and measuring/analyzing the machine characteristics.

<Main functions>

Bode diagram measurement display, speed loop gain adjustment, position loop gain adjustment, notch filter setting, acceleration/deceleration time constant adjustment, circularity adjustment and servo waveform measurement.

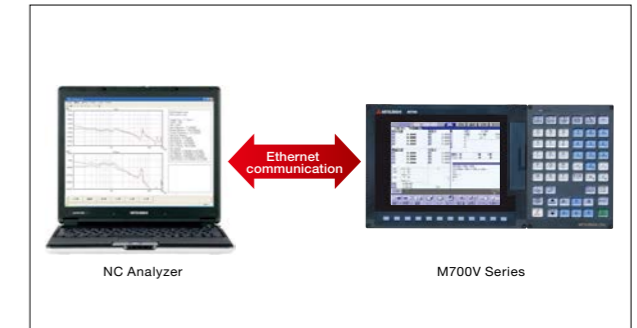

### NC Monitor (Remote Monitoring Tool)

An identical NC display screen can be displayed on a personal computer. By connecting a personal computer to the NC unit when necessary, various data can be checked and set using the same HMI as the standard NC screen.

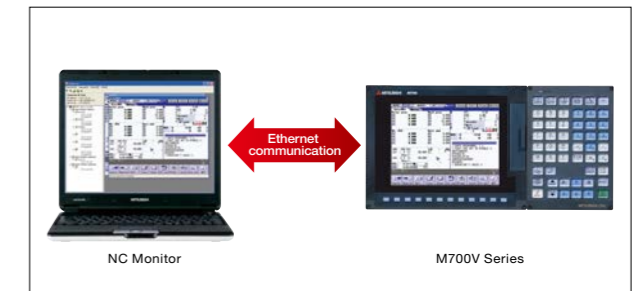

### NC Explorer (Data Transfer Tool)

By connecting the NC and host personal computer via Ethernet, data such as machining programs can easily be shared. This tool is free of charge. Please contact us.

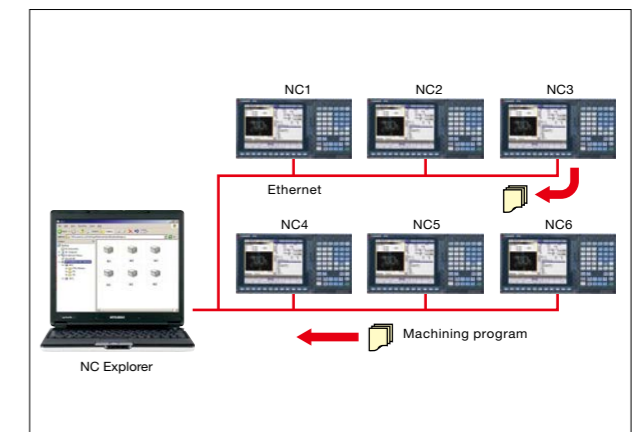

# Solution

A wide range of support features according to various machine configurations

Easy to import external data via USB and memory card interfaces.

A wide array of network functions offers good compatibility with various machine configurations.

## Memory Card/USB Memory Interface

A compact flash memory card (CF card) <sup>(Note)</sup> /USB memory interface is located on the front of the display. In using CF card, the card slot can be completely covered by a lid so as to prevent foreign materials from entering (IP67).

(Note) M700VW Series is equipped with PCMCIA interface

Example of M700VS Series

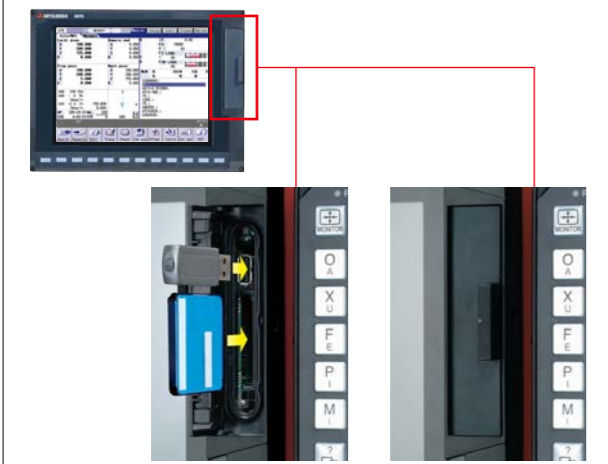

## Ethernet Communication

By connecting a personal computer and an CNC via Ethernet, the machining programs and parameters can be input and output.

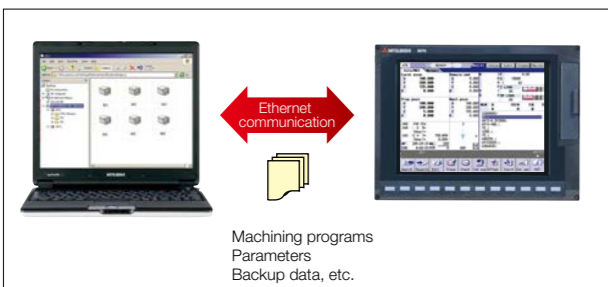

## Front IC Card Mode

- It is possible to directly search and run the machining programs from the CF card (or PCMCIA card for M700VW Series). Subprogram calls are also available.
- The machining programs in the CF card can be edited directly.

## Easy to Change Languages

- Display languages can be switched with a single parameter operation.
- For guidance display, two other languages aside from English are selectable for M700VS Series, or all the desired languages for M700VW Series by option setting.
- Support for 17 languages, securing reliable use worldwide.



Languages supported	
Japanese	Portuguese
English	Hungarian
German	Dutch
Italian	Swedish
French	Turkish
Spanish	Polish
Chinese (traditional)	Russian
Chinese (simplified)	Czech
Korean	

# M700V series

## CC-Link

The NC unit can be connected to a network to serve as the master/local station of the MELSEC CC-Link.

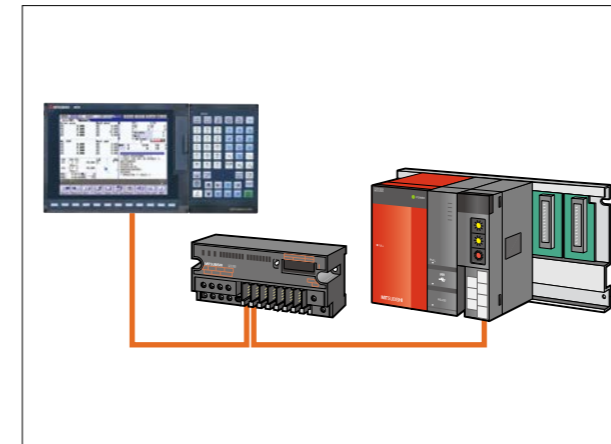

## Optical Communication Repeater Unit

The optical cable can be extended to a maximum of 90m by connecting up to two optical servo communication repeater units between the CNC unit and a servo drive unit.

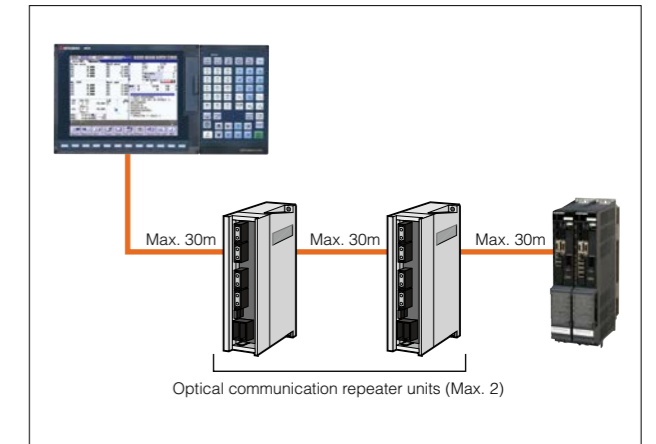

## Mitsubishi Factory Automation Solutions

- Our cultivated Factory Automation technologies and experience contribute to offer the best suited systems for users.
- Our FA solutions support high and low hierarchy components, a network and even applications that control the components and network required for a manufacturing floor.

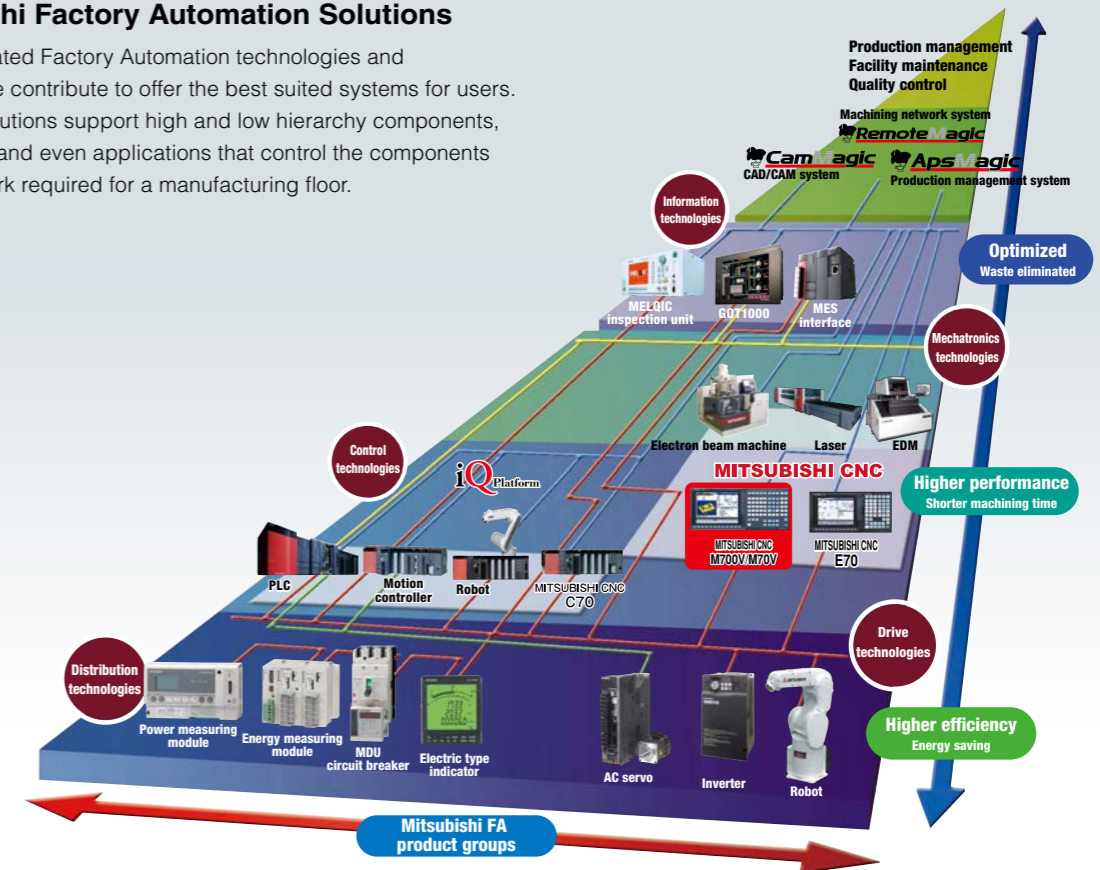

## WARRANTY

Please confirm the following product warranty details before using MITSUBISHI CNC.

### 1. Warranty Period and Coverage

Should any fault or defect (hereafter called "failure") for which we are liable occur in this product during the warranty period, we shall provide repair services at no cost through the distributor from which the product was purchased or through a Mitsubishi Electric service provider. Note, however that this shall not apply if the customer was informed prior to purchase of the product that the product is not covered under warranty. Also note that we are not responsible for any on-site readjustment and/or trial run that may be required after a defective unit is replaced.

### [Warranty Term]

The term of warranty for this product shall be twenty-four (24) months from the date of delivery of product to the end user, provided the product purchased from us in Japan is installed in Japan (but in no event longer than thirty (30) months, including the distribution time after shipment from Mitsubishi Electric or its distributor).

Note that, for the case where the product purchased from us in or outside Japan is exported and installed in any country other than where it was purchased; please refer to "2. Service in overseas countries" as will be explained.

### [Limitations]

- (1) The customer is requested to conduct an initial failure diagnosis by him/herself, as a general rule. It can also be carried out by us or our service provider upon the customer's request and the actual cost will be charged.
- (2) This warranty applies only when the conditions, method, environment, etc., of use are in compliance with the terms and conditions and instructions that are set forth in the instruction manual, user's manual, and the caution label affixed to the product, etc.
- (3) Even during the term of warranty, repair costs shall be charged to the customer in the following cases:
  - (a) a failure caused by improper storage or handling, carelessness or negligence, etc., or a failure caused by the customer's hardware or software problem
  - (b) a failure caused by any alteration, etc., to the product made by the customer without Mitsubishi Electric's approval
  - (c) a failure which may be regarded as avoidable, if the customer's equipment in which this product is incorporated is equipped with a safety device required by applicable laws or has any function or structure considered to be indispensable in the light of common sense in the industry
  - (d) a failure which may be regarded as avoidable if consumable parts designated in the instruction manual, etc. are duly maintained and replaced
  - (e) any replacement of consumable parts (including a battery, relay and fuse)
  - (f) a failure caused by external factors such as inevitable accidents, including without limitation fire and abnormal fluctuation of voltage, and acts of God, including without limitation earthquake, lightning, and natural disasters

- (g) a failure which is unforeseeable under technologies available at the time of shipment of this product from our company
- (h) any other failures which we are not responsible for or which the customer acknowledges we are not responsible for

### 2. Service in Overseas Countries

If the customer installs the product purchased from us in his/her machine or equipment, and export it to any country other than where he/she bought it, the customer may sign a paid warranty contract with our local FA center. This falls under the case where the product purchased from us in or outside Japan is exported and installed in any country other than where it was purchased. For details please contact the distributor from which the customer purchased the product.

### 3. Exclusion of Responsibility for Compensation against Loss of Opportunity, Secondary Loss, etc.

Whether during or after the term of warranty, we assume no responsibility for any damages arising from causes for which we are not responsible, any losses of opportunity and/or profit incurred by the customer due to a failure of this product, any damages, secondary damages or compensation for accidents arising under specific circumstances that either foreseen or unforeseen by Mitsubishi Electric, any damages to products other than this product, or compensation for any replacement work, readjustment and startup test run of on-site machines or any other operations conducted by the customer.

### 4. Changes in Product Specifications

Specifications shown in our catalogs, manuals or technical documents are subject to change without notice.

### 5. Product Application

- (1) For the use of this product, its applications should be those that may not result in a serious damage even if any failure or malfunction occurs in the product, and a backup or fail-safe function should operate on an external system to the product when any failure or malfunction occurs.
- (2) Mitsubishi CNC is designed and manufactured solely for applications to machine tools to be used for industrial purposes. Do not use this product in any applications other than those specified above, especially those which are substantially influential on the public interest or which are expected to have significant influence on human lives or properties.

## Control Unit

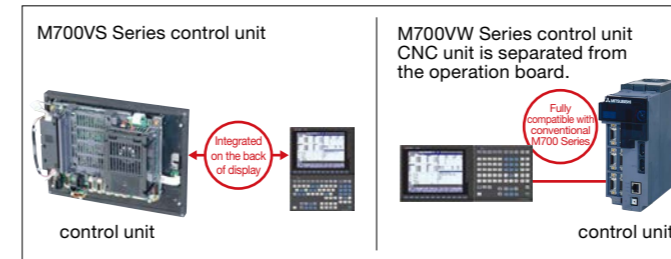

## MITSUBISHI CNC Machine Operation Panel

		[mm]
FCU7-KB921	Key switch 55 points, LED 55 points MITSUBISHI standard key layout	
FCU7-KB926	Rotary switches (spindle override, cutting override) Select switch (memory protection) Emergency stop push-button	

-The internal components of the machine operation panel are protected against water and oil (IP65F).  
-Refer to the product brochure for details.

## Displays & Keyboard

M700VS Series					
Keyboard	Display	8.4-type	10.4-type	10.4-type touch panel	15-type
FCU7-KB024 sheet keys	FCU7-KB044 sheet keys				—
FCU7-KB025 Lathe system sheet keys	FCU7-KB046 clear keys				—
FCU7-KB026 clear keys	FCU7-KB048 clear keys				
FCU7-KB028 Lathe system clear keys	FCU7-KB047 clear keys				
FCU7-KB029 sheet keys					

M700VW Series					
Keyboard	Display	10.4-type	10.4-type touch panel	15-type	15-type touch panel
FCU7-KB041 clear keys					
FCU7-KB045 clear keys					

The internal components of the keyboard are protected against water and oil (IP65F). The interface for USB memory and CF card (PCMCIA II for M700VW Series) are mounted on the front panel of the display.

\* Trademarks  
MELDAS, MELSEC, EZSocket, EZMotion, iQ Platform, MELSOFT, GOT, CC-Link, CC-Link/LT and CC-Link IE are either trademarks or registered trademarks of Mitsubishi Electric Corporation in Japan and/or other countries.  
Ethernet is a registered trademark of Xerox Corporation in the United States and/or other countries.  
Microsoft® and Windows® are either trademarks or registered trademarks of Microsoft Corporation in the United States and/or other countries.  
CompactFlash and CF are either trademarks or registered trademarks of SanDisk Corporation in the United States and/or other countries.  
Other company and product names that appear in this manual are trademarks or registered trademarks of the respective companies.

## Servo Motors

### Medium-inertia Motor HF Series

- Medium-inertia, high-accuracy and high-speed motors
- High-inertia machine accuracy is ensured. Suitable for machines requiring quick acceleration.
- Range: 0.5 to 9 [kW]
- Maximum speed: 4,000 or 5,000 [r/min]
- Supports three types of detectors with a resolution of 260,000, 1 million or 16 million p/rev.



### Low-inertia Motor HF-KP Series

- Small-capacity, low-inertia motors
- Suitable for an auxiliary axis that require high-speed positioning
- Range: 0.1 to 0.75[kW]
- Maximum speed: 6,000 [r/min]
- Supports a detector with a resolution of 260,000p/rev.



### Linear Servo Motor LM-F Series

- Use in clean environments is possible since no ball screws are used and therefore contamination from grease is not an issue.
- Elimination of transmission mechanisms which include backlash, enables smooth and quiet operation even at high speeds.
- Dimensions:  
Length: 290 to 1,010 [mm]  
Width: 120 to 240 [mm]



### Direct Drive Servo Motor TM-RB Series

- High-torque direct-drive combined motor with a high-gain control system provides quick acceleration and positioning, which makes rotation smoother.
- Suitable for a rotary axis that drives a table or spindle head.
- Compared with a conventional rotary axis with a deceleration gear, this motor has higher accuracy and is maintenance-free, having no wear or backlash.
- Range:  
Maximum torque: 36 to 1,280 [N·m]



## Spindle Motors

### High-performance New Type Spindle Motor SJ-D Series

- Motor energy loss has been significantly reduced by optimizing the magnetic circuit.
- High-speed-specification bearings are equipped as standard, achieving higher-speed, lower vibration and improved durability.
- Product line:  
Normal SJ-D Series 3.7 to 11 [kW]  
Compact & light SJ-DJ Series 5.5 to 15 [kW]



### High-performance Spindle Motor SJ-V Series

- A vast range of spindle motors is available, including standard, high-speed and wide-range output units, all ready to support diversified machine tool needs.
- Product line:  
Normal SJ-V Series 0.75 to 55 [kW]  
Wide-range constant output SJ-V Series 5.5 to 18.5 [kW]  
High-speed SJ-V-Z Series 2.2 to 22 [kW]  
Hollow-shaft SJ-VS Series 5.5 to 18.5 [kW]



### Low-inertia, High-speed New Type Spindle Motor SJ-DL Series

- Tapping machine-dedicated spindle motors have joined the new spindle motor line SJ-D Series in an effort to speed up drilling and tapping.
- Our cutting-edge design technologies have brought forth higher rigidity and lower vibration of motor despite its light weight.
- The low-inertia reduces acceleration/deceleration time, resulting in higher productivity.
- Product line:  
Low-inertia SJ-DL Series 0.75 to 7.5 [kW]



### Low-inertia, High-speed Spindle Motor SJ-VL Series

- The spindle dedicated to tapping machines requiring faster drilling and tapping.
- The low-inertia reduces acceleration/deceleration time, resulting in higher productivity. In addition, when driven by a multi-hybrid drive (MDS-DM2 Series), this motor contributes to downsizing of the cabinet, and energy savings.
- Hollow-shaft specifications are also available.
- Product line:  
Low-inertia normal SJ-VL Series 3.0 to 11 [kW]  
Low-inertia hollow shaft SJ-VLS Series 3.7 to 11 [kW]



### Built-in Spindle Motor SJ-BG Series

- The optimized electrical design increases the continuous rated torque per unit volume compared to our conventional model, contributing to downsizing of the spindle unit.
- The mold with cooling jacket is available as an optional feature.



### Tool Spindle Motor HF-KP/HF-SP Series

- Taking advantage of the characteristics of a servo motor such as smallness and high-output, this motor serves as a compact and high-output spindle motor which is capable of high-speed rotation (6,000r/min). This motor contributes to downsizing of spindles, such as the rotary tool spindle.
- Product line:  
Small capacity HF-KP Series 0.4 to 0.9 [kW]  
Medium capacity HF-SP Series 2.2 to 4 [kW]



## Drive Units

### High-performance Servo/Spindle Drive Units MDS-D2/DH2 Series

- With the fastest current control cycle, basic performance is drastically enhanced (high-gain control). A combination of high-speed servo motor and high-accuracy detector helps enhance overall drive performance.
- High-speed optical communication enables a shorter position interpolation cycle and direct communication between drives, promoting further high-speed and high-accuracy machining.
- A high-efficiency fin and low-loss power module have enabled unit downsizing. A line of drive units driving a maximum of two spindles is available, contributing to a reduction in control panel size.
- STO (safe torque off) is now available. (Note)



### Multi-hybrid Drive Units MDS-DM2 Series

- A line of high-performance multi-hybrid drive units are available. The multi-hybrid drive unit drives a maximum of three servo axes and one spindle, supporting the downsizing of units and offering technical advantages.
- A power regeneration system that efficiently uses energy during deceleration as power contributes to highly-frequent acceleration/deceleration and energy savings.
- STO (safe torque off) is now available. (Note)



### All-in-one compact drive units MDS-DJ Series

- Ultra-compact drive units with built-in power supplies contribute to reducing control panel size. The 2-axis type is added for further downsizing.
- High-speed optical communication enables a shorter position interpolation cycle and direct communication between drives, promoting further high-speed and high-accuracy machining.
- A high-efficiency fin and low-loss power module have enabled unit downsizing, which also leads to a reduction in control panel size.
- STO (safe torque off) is now available. (Note)



(Note) Please contact us for availability of STO as a whole system.

## Main Specifications

Specifications	Machining center system			Lathe system			Machining center system			Lathe system		
	M720VS	M730VS	M750VS	M720VS	M730VS	M750VS	M720VW	M730VW	M750VW	M720VW	M730VW	M750VW
Max. number of axes (NC axes + Spindles + PLC axes)	12	16	16	12	16	16	12	16	16	12	16	16
Max. number of NC axes (in total for all the part systems)	8	16	16	12	16	16	8	16	16	12	16	16
Max. number of spindles	4			4	6		4			4	6	
Max. number of PLC axes	6			6			6			6		
Max. number of auxiliary axes	—			—			4	6		4	6	
Max. number of PLC indexing axes	4	6		4	6		4	6		4	6	
Number of simultaneous contouring control axes	4			4	8		4	8		4	8	
Max. number of NC axes in a part system	6	8		6	8		6	8		6	8	
Max. number of part systems	2			2	4		2			2	4	
CF card in control unit	—			—			Available			Available		
Front IC card mode	Available			Available			Available			Available		
Hard disk mode	—			—			Available			Available		
Least command increment	0.1μm	1nm		0.1μm	1nm		0.1μm	1nm		0.1μm	1nm	
Least control increment	1nm			1nm			1nm			1nm		
Max. program capacity	2,000kB (5,120m)			2,000kB (5,120m)			2,000kB (5,120m)			2,000kB (5,120m)		
Max. PLC program capacity	128,000 steps			128,000 steps			128,000 steps			128,000 steps		
Milling interpolation	—	—	—	△	△	△	—	—	—	△	△	△
High-speed synchronous tapping(OMR-DD)	○	○	○	○	○	○	○	○	○	○	○	○
Guide bushing spindle synchronization	—	—	—	△	△	△	—	—	—	△	△	△
Tool spindle synchronization II (Hobbing)	—	—	—	△	△	△	—	—	—	△	△	△
Mixed control (cross axis control)	—	—	—	△	△	△	—	—	—	△	△	△
Control axis superimposition	—	—	—	△	△	△	—	—	—	△	△	△
Control axis synchronization across part systems	—	—	—	△	△	△	—	—	—	△	△	△
Balance cut	—	—	—	△	△	△	—	—	—	△	△	△
2-part system synchronous thread cutting	—	—	—	△	△	△	—	—	—	△	△	△
Multi-part system program management	○	○	○	○	○	○	○	○	○	○	○	○
SSS control (Note 1)	△	△	△	—	—	—	△	△	△	—	—	—
3D Machine Interference check	—	—	—	—	—	—	—	—	—	△	△	△
Tool handle feed & interruption	—	△	△	—	—	—	—	—	—	△	△	△
Tool center point control	—	—	△	—	—	—	—	—	—	△	△	△
Inclined surface machining command	△	△	△	—	—	—	△	△	△	—	—	—
R-Navi	△	△	△	—	—	—	△	△	△	—	—	—

\*Maximum specifications including optional specifications are listed.

(Note 1) In order to use this function also in the 2nd part system, the option "High-accuracy control in 2 part systems" is required.

Refer to the specifications manuals.

# Global Partner. Local Friend.



[YouTube logo] is a trademark or a registered trademark of Google LLC.

**Official Mitsubishi Electric Mechatronics YouTube account**  
User support videos will be available, including how to backup/restore data and replace batteries as well as introduction to our products and technologies.

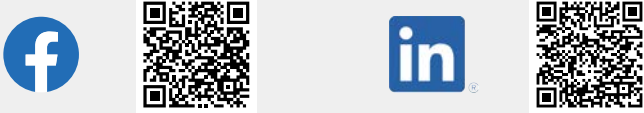

[Facebook logo] is a trademark or a registered trademark of Facebook, inc. [LinkedIn logo] is a trademark or a registered trademark of LinkedIn Corporation.

**Official Mitsubishi Electric CNC Facebook/LinkedIn account**  
Visit our page for information about exhibitions, products, technologies, and FAQ.

 **Safety Warning**

To ensure proper use of the products listed in this catalog, please be sure to read the instruction manual prior to use.

Mitsubishi Electric Corporation Industrial Mechatronics Systems Works is a factory certified for ISO 14001 (standards for environmental management systems) and ISO 9001 (standards for quality assurance management systems)

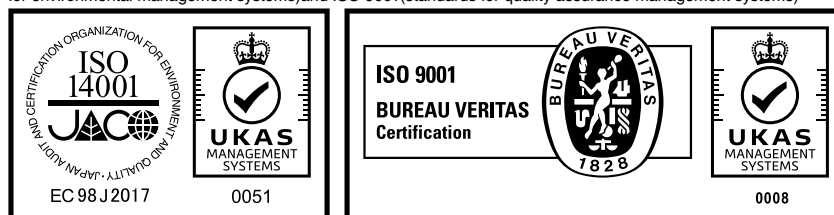

ISO 14001 JACO EC 98.J2017 UKAS MANAGEMENT SYSTEMS 0051

ISO 9001 BUREAU VERITAS Certification 1828 UKAS MANAGEMENT SYSTEMS 0008

## MITSUBISHI ELECTRIC CORPORATION

HEAD OFFICE: TOKYO BLDG., 2-7-3, MARUNOUCHI, CHIYODA-KU, TOKYO 100-8310, JAPAN  
<http://Global.MitsubishiElectric.com>

BNP-A1210-K(ENG)  
(ENGLISH)