

Numerical Control (CNC)

# **Alarm/Parameter Manual**

## **C80 Series**

# Introduction

This manual describes the alarms and parameters of Mitsubishi Electric CNC.

Improper handling can cause unexpected malfunctions. To use this device correctly, be sure to read this manual before use.

Supported model of this manual is as follows:

Supported model	Abbreviation in this manual
C80 Series	C80

To safely use this CNC unit, thoroughly study the "Precautions for Safety" before use.

Be sure to keep this manual on hand so that users can refer to it at any time.

Also refer to the manuals on "Manual List" as necessary.

## Notes on reading this manual

(1) This manual explains general parameters which are operated on the CNC side.

For information about each machine tool, refer to manuals issued by the machine tool builder.

If the descriptions relating to "restrictions" and "allowable conditions" conflict between this manual and the machine tool builder's manual, the later has priority over the former.

(2) This manual is intended to contain as much descriptions as possible even about special operations.

The operations to which no reference is made in this manual should be considered "impossible".

## Details described in this manual

•In this manual, the following abbreviations might be used.

L system: Lathe system

M system: Machining center system

MTB: Machine tool builder

## Manual List

Manuals related to M800/M80/E80/C80 Series are listed as follows.

These manuals are written on the assumption that all optional functions are added to the targeted model.

Some functions or screens may not be available depending on the machine or specifications set by MTB. (Confirm the specifications before use.)

The manuals issued by MTB take precedence over these manuals.

Manual	IB No.	Purpose and Contents
M800/M80/E80 Series Instruction Manual	IB-1501274	<ul style="list-style-type: none"> <li>◆ Operation guide for NC</li> <li>◆ Explanation for screen operation, etc.</li> </ul>
C80 Series Instruction Manual	IB-1501453	<ul style="list-style-type: none"> <li>◆ Operation guide for NC</li> <li>◆ Explanation for screen operation, etc.</li> </ul>
M800/M80/E80/C80 Series Programming Manual (Lathe System) (1/2)	IB-1501275	<ul style="list-style-type: none"> <li>◆ G code programming for lathe system</li> <li>◆ Basic functions, etc.</li> </ul>
M800/M80/E80/C80 Series Programming Manual (Lathe System) (2/2)	IB-1501276	<ul style="list-style-type: none"> <li>◆ G code programming for lathe system</li> <li>◆ Functions for multi-part system, high-accuracy function, etc.</li> </ul>
M800/M80/E80/C80 Series Programming Manual (Machining Center System) (1/2)	IB-1501277	<ul style="list-style-type: none"> <li>◆ G code programming for machining center system</li> <li>◆ Basic functions, etc.</li> </ul>
M800/M80/E80/C80 Series Programming Manual (Machining Center System) (2/2)	IB-1501278	<ul style="list-style-type: none"> <li>◆ G code programming for machining center system</li> <li>◆ Functions for multi-part system, high-accuracy function, etc.</li> </ul>
M800/M80/E80 Series Alarm/Parameter Manual	IB-1501279	<ul style="list-style-type: none"> <li>◆ Alarms</li> <li>◆ Parameters</li> </ul>
C80 Series Alarm/Parameter Manual	IB-1501560	<ul style="list-style-type: none"> <li>◆ Alarms</li> <li>◆ Parameters</li> </ul>

Manuals for MTBs (NC)

Manual	IB No.	Purpose and Contents
M800/M80/E80/C80 Series Specifications Manual (Function)	IB-1501505	<ul style="list-style-type: none"> <li>♦ Model selection</li> <li>♦ Outline of various functions</li> </ul>
M800/M80/E80/C80 Series Specifications Manual (Hardware)	IB-1501506	<ul style="list-style-type: none"> <li>♦ Model selection</li> <li>♦ Specifications of hardware unit</li> </ul>
M800W/M80W Series Connection and Setup Manual	IB-1501268	<ul style="list-style-type: none"> <li>♦ Detailed specifications of hardware unit</li> <li>♦ Installation, connection, wiring, setup (startup/adjustment)</li> </ul>
M800S/M80/E80 Series Connection and Setup Manual	IB-1501269	<ul style="list-style-type: none"> <li>♦ Detailed specifications of hardware unit</li> <li>♦ Installation, connection, wiring, setup (startup/adjustment)</li> </ul>
C80 Series Connection and Setup Manual	IB-1501452	<ul style="list-style-type: none"> <li>♦ Detailed specifications of hardware unit</li> <li>♦ Installation, connection, wiring, setup (startup/adjustment)</li> </ul>
M800/M80/E80 Series PLC Development Manual	IB-1501270	<ul style="list-style-type: none"> <li>♦ Electrical design</li> <li>♦ I/O relation (assignment, setting, connection), field network</li> <li>♦ Development environment (PLC on-board, peripheral development environment), etc.</li> </ul>
M800/M80/E80 Series PLC Programming Manual	IB-1501271	<ul style="list-style-type: none"> <li>♦ Electrical design</li> <li>♦ Sequence programming</li> <li>♦ PLC support functions, etc.</li> </ul>
M800/M80/E80/C80 Series PLC Interface Manual	IB-1501272	<ul style="list-style-type: none"> <li>♦ Electrical design</li> <li>♦ Interface signals between NC and PLC</li> </ul>
M800/M80/E80 Series Maintenance Manual	IB-1501273	<ul style="list-style-type: none"> <li>♦ Cleaning and replacement for each unit</li> <li>♦ Other items related to maintenance</li> </ul>
C80 Series Maintenance Manual	IB-1501454	<ul style="list-style-type: none"> <li>♦ Cleaning and replacement for each unit</li> <li>♦ Other items related to maintenance</li> </ul>

Manuals for MTBs (drive section)

Manual	IB No.	Contents
MDS-E/EH Series Specifications Manual	IB-1501226	<ul style="list-style-type: none"> <li>♦ Specifications for power supply regeneration type</li> </ul>
MDS-E/EH Series Instruction Manual	IB-1501229	<ul style="list-style-type: none"> <li>♦ Instruction for power supply regeneration type</li> </ul>
MDS-EJ/EJH Series Specifications Manual	IB-1501232	<ul style="list-style-type: none"> <li>♦ Specifications for regenerative resistor type</li> </ul>
MDS-EJ/EJH Series Instruction Manual	IB-1501235	<ul style="list-style-type: none"> <li>♦ Instruction for regenerative resistor type</li> </ul>
MDS-EM/EMH Series Specifications Manual	IB-1501238	<ul style="list-style-type: none"> <li>♦ Specifications for multi-hybrid, power supply regeneration type</li> </ul>
MDS-EM/EMH Series Instruction Manual	IB-1501241	<ul style="list-style-type: none"> <li>♦ Instruction for multi-hybrid, power supply regeneration type</li> </ul>
DATA BOOK	IB-1501252	<ul style="list-style-type: none"> <li>♦ Specifications of servo drive unit, spindle drive unit, motor, etc.</li> </ul>

Manuals for MTBs (Others)

Manual	No.	Purpose and Contents
GOT2000 Series User's Manual (Hardware)	SH-081194ENG	♦ Outline of hardware such as part names, external dimensions, installation, wiring, maintenance, etc. of GOTs
GOT2000 Series User's Manual (Utility)	SH-081195ENG	♦ Outline of utilities such as screen display setting, operation method, etc. of GOTs
GOT2000 Series User's Manual (Monitor)	SH-081196ENG	♦ Outline of each monitor function of GOTs
GOT2000 Series Connection Manual (Mitsubishi Electric Products)	SH-081197ENG	♦ Outline of connection types and connection method between GOT and Mitsubishi Electric connection devices
GT Designer3 (GOT2000) Screen Design Manual	SH-081220ENG	♦ Outline of screen design method using screen creation software GT Designer3

■ For M800/M80/E80 Series

Manual	No.	Purpose and Contents
GOT2000/GOT1000 Series CC-Link Communication Unit User's Manual	IB-0800351	♦ Explanation for handling CC-Link communication unit (for GOT2000 series/GOT1000 series)
GX Developer Version 8 Operating Manual (Startup)	SH-080372E	♦ Explanation for system configuration, installation, etc. of PLC development tool GX Developer
GX Developer Version 8 Operating Manual	SH-080373E	♦ Explanation for operations using PLC development tool GX Developer
GX Converter Version 1 Operating Manual	IB-0800004	♦ Explanation for operations using data conversion tool GX Converter
GX Works2 Installation Instructions	BCN-P5999-0944	♦ Explanation for the operating environment and installation method of GX Works2
GX Works2 Version 1 Operating Manual (Common)	SH-080779ENG	♦ Explanation for the system configuration of GX Works2 and the functions common to Simple project and Structured project such as parameter setting, operation method for the online function
GX Works2 Version 1 Operating Manual (Simple Project)	SH-080780ENG	♦ Explanation for methods for such as creating and monitoring programs in Simple project of GX Works2
GX Works2 Version 1 Operating Manual (Simple Project, Function Block)	SH-080984ENG	♦ Explanation for methods for such as creating function blocks, pasting function blocks to sequence programs, and operating FB library in Simple project of GX Works2
GX Works2 Version 1 Operating Manual (Structured Project)	SH-080781ENG	♦ Explanation for methods for such as creating and monitoring programs in Structured project of GX Works2
GX Works3 Installation Instructions	BCN-P5999-0391	♦ Explanation for the operating environment and installation method of GX Works3
MELSEC-Q CC-Link System Master/Local Module User's Manual	SH-080394E	♦ Explanation for system configuration, installation, wiring, etc. of master/local modules for CC-Link system
GOT2000 Series Connection Manual (Non-Mitsubishi Electric Products 1)	SH-081198ENG	♦ Explanation for connection types and connection method between GOT and other company's devices
GOT2000 Series Connection Manual (Non-Mitsubishi Electric Products 2)	SH-081199ENG	
GOT2000 Series Connection Manual (Microcomputers, MODBUS/Fieldbus Products, Peripherals)	SH-081200ENG	♦ Explanation for connection types and connection method between GOT and microcomputers, MODBUS/fieldbus products, peripherals
GT SoftGOT2000 Version1 Operating Manual	SH-081201ENG	♦ Explanation for system configuration, screen configuration and operation method of monitoring software GT SoftGOT2000

■ For C80 Series

Manual	No.	Purpose and Contents
MELSEC iQ-R Module Configuration Manual	SH-081262	♦ Outline of system configuration, specifications, installation, wiring, maintenance, etc.
MELSEC iQ-R CPU Module User's Manual (Startup)	SH-081263	♦ Outline of specifications, procedures before operation, troubleshooting, etc. for CPU module
MELSEC iQ-R CPU Module User's Manual (Application)	SH-081264	♦ Outline of memory, functions, devices, parameters, etc. for CPU module
MELSEC iQ-R CC-Link IE Field Network User's Manual (Application)	SH-081259	♦ Explanation for functions, parameter settings, programming, troubleshooting, etc. of the CC-Link IE Field Network function
QCPU User's Manual (Hardware Design, Maintenance and Inspection)	SH-080483	♦ Outline of specifications, necessary knowledge to configure the system and maintenance-related descriptions for Q series CPU module, etc.
GX Works3 Operating Manual	SH-081215	♦ Outline of functions, programming, etc.

Reference Manual for MTBs

Manual	No.	Purpose and Contents
M800/M80 Series Smart safety observation Specification manual	BNP-C3072-022	♦ Explanation for smart safety observation function
C80 Series Smart safety observation Specification manual	BNP-C3077-022	
M800/M80 Series CC-Link (Master/Local) Specification manual	BNP-C3072-089	♦ Explanation for CC-Link
M800/M80 Series PROFIBUS-DP Specification manual	BNP-C3072-118	♦ Explanation for PROFIBUS-DP communication function
M800/M80 Series Interactive cycle insertion (Customization) Specification manual	BNP-C3072-121-0003	♦ Explanation for interactive cycle insertion
M800/M80 Series EtherNet/IP Specifications manual	BNP-C3072-263	♦ Explanation for EtherNet/IP
M800/M80 Series CC-Link IE Field (Master/local) Specifications manual	BNP-C3072-283	♦ Explanation for CC-Link IE Field
M800/M80 Series GOT Connection Specifications manual	BNP-C3072-314	♦ Explanation for GOT connection
M800/M80 Series CC-Link IE Field Basic Specifications manual	BNP-C3072-337	♦ Explanation for CC-Link IE Field Basic
M800/M80 Series FL-net Specifications manual	BNP-C3072-368	♦ Explanation for FL-net
M800/M80 Series Synchronous Control Specifications manual	BNP-C3072-074	♦ Explanation for synchronous control
M800/M80 Series Multiple-Axis Synchronization Control Specifications manual	BNP-C3072-339	♦ Explanation for multiple-axis synchronization control

## Precautions for Safety

Always read the specifications issued by the machine tool builder, this manual, related manuals and attached documents before installation, operation, programming, maintenance or inspection to ensure correct use. Understand this numerical controller, safety items and cautions before using the unit. This manual ranks the safety precautions into "DANGER", "WARNING" and "CAUTION".



 **DANGER**  
When the user may be subject to imminent fatalities or major injuries if handling is mistaken.



 **WARNING**  
When the user may be subject to fatalities or major injuries if handling is mistaken.

 **CAUTION**  
When the user may be subject to medium or minor injuries or when only property damage may occur, if handling is mistaken.

Note that even items ranked as " CAUTION" may lead to serious consequences depending on the situation. All the items are important and must always be observed.

The following signs indicate prohibition and compulsory.

 This sign indicates prohibited behavior (must not do).  
For example,  indicates "Keep fire away".

 This sign indicates a thing that is compulsory (must do).  
For example,  indicates "it must be grounded".

The meaning of each pictorial sign is as follows.

 CAUTION	 CAUTION rotated object	 CAUTION HOT	 Danger Electric shock risk	 Danger explosive
 Prohibited	 Disassembly is prohibited	 KEEP FIRE AWAY	 General instruction	 Earth ground

### For Safe Use

Mitsubishi Electric CNC is designed and manufactured solely for applications to machine tools to be used for industrial purposes.

Do not use this product in any applications other than those specified above, especially those which are substantially influential on the public interest or which are expected to have significant influence on human lives or properties.

 **DANGER**

Not applicable in this manual.

 **WARNING**

Not applicable in this manual.

## ⚠ CAUTION

### (1) Product and manual

- ⚠ For items described as "Restrictions" or "Usable State" in this manual, the instruction manual issued by the machine tool builder takes precedence over this manual.
- ⚠ Items not described in this manual must be interpreted as "not possible".
- ⚠ This manual is written on the assumption that all the applicable functions are included. Some of them, however, may not be available for your NC system. Refer to the specifications issued by the machine tool builder before use.
- ⚠ Refer to the Instruction Manual issued by each machine tool builder for details on each machine tool.
- ⚠ Some screens and functions may differ depending on the NC system (or its version), and some functions may not be possible. Please confirm the specifications before use.
- ⚠ To protect the availability, integrity and confidentiality of the NC system against cyber-attacks including unauthorized access, denial-of-service (DoS) (\*1) attack, and computer virus from external sources via a network, take security measures such as firewall, VPN, and anti-virus software.  
(\*1) Denial-of-service (DoS) refers to a type of cyber-attack that disrupts services by overloading the system or by exploiting a vulnerability of the system.
- ⚠ Mitsubishi Electric assumes no responsibility for any problems caused to the NC system by any type of cyber-attacks including DoS attack, unauthorized access and computer virus.

### (2) Adjustments

- ⚠ Do not adjust or change the parameter settings greatly as operation could become unstable.
- ⚠ In the explanation on bits, set all bits not used, including blank bits, to "0".

### (3) Troubleshooting

- ❗ If the battery low warning is issued in the controller side, save the machining programs, tool data and parameters in an input/output device, and then replace the battery. When the battery alarm is issued, the machining programs, tool data and parameters may have been destroyed. Replace the battery and then reload the data.
- ⚠ If the battery low warning is issued in the drive unit side, immediately replace the battery. Replace the batteries while applying the drive unit's control power.

### (4) Maintenance, inspection and part replacement

- ⚠ Do not short-circuit, charge, heat, incinerate or disassemble the battery.
- ⚠ Dispose of the spent battery according to local laws.



## Disposal



(Note) This symbol mark is for EU countries only.  
This symbol mark is according to the directive 2006/66/EC Article 20 Information for end-users and Annex II.

Your MITSUBISHI ELECTRIC product is designed and manufactured with high quality materials and components which can be recycled and/or reused.

This symbol means that batteries and accumulators, at their end-of-life, should be disposed of separately from your household waste.

If a chemical symbol is printed beneath the symbol shown above, this chemical symbol means that the battery or accumulator contains a heavy metal at a certain concentration. This will be indicated as follows:

Hg: mercury (0,0005%), Cd: cadmium (0,002%), Pb: lead (0,004%)

In the European Union there are separate collection systems for used batteries and accumulators.

Please, dispose of batteries and accumulators correctly at your local community waste collection/recycling centre.

Please, help us to conserve the environment we live in!

## Trademarks

MELDAS, MELSEC, EZSocket, EZMotion, iQ Platform, MELSEC iQ-R, MELSOFT, GOT, CC-Link, CC-Link/LT, CC-Link IE, CC-Link IE/field, EcoMonitorLight and SLMP are either trademarks or registered trademarks of Mitsubishi Electric Corporation in Japan and/or other countries.

Ethernet is a registered trademark of Xerox Corporation in the United States and/or other countries.

Microsoft®, Windows®, SQL Server® and Access® are either trademarks or registered trademarks of Microsoft Corporation in the United States and/or other countries.

SD logo and SDHC logo are either registered trademarks or trademarks of LLC.

UNIX is a registered trademark of The Open Group in the United States and/or other countries.

Intel® and Pentium® are either trademarks or registered trademarks of Intel Corporation in the United States and/or other countries.

MODBUS® is either a trademark or a registered trademark of Schneider Electric USA, Inc. or the affiliated companies in Japan and/or other countries.

EtherNet/IP is a trademark of Open DeviceNet Vendor Association, Inc.

PROFIBUS-DP and PROFINET are either trademarks or registered trademarks of PROFIBUS User Organization.

Oracle® is a registered trademark of Oracle Corporation, the subsidiaries, or the affiliated companies in the United States and /or other countries.

VNC is a registered trademark of RealVNC Ltd. in the United States and other countries.

Punchtap is licensed by EMUGE.

BiSS is a registered trademark of iC-Haus GmbH.

Other company and product names that appear in this manual are trademarks or registered trademarks of the respective companies.

## 本製品の取扱いについて

(日本語 /Japanese)

本製品は工業用(クラス A)電磁環境適合機器です。販売者あるいは使用者はこの点に注意し、住商業環境以外での使用をお願いいたします。

## Handling of our product

(English)

This is a class A product. In a domestic environment this product may cause radio interference in which case the user may be required to take adequate measures.

## 본 제품의 취급에 대해서

(한국어 /Korean)

이 기기는 업무용(A급) 전자파적합기기로서 판매자 또는 사용자는 이 점을 주의하시기 바라며 가정외의 지역에서 사용하는 것을 목적으로 합니다.

# Contents

## Alarm

<b>1 Operation Errors (M)</b> .....	<b>3</b>
<b>2 Stop Codes (T)</b> .....	<b>39</b>
<b>3 Servo/Spindle Alarms (S)</b> .....	<b>49</b>
3.1 Servo Errors (S01/S03/S04).....	50
3.2 Initial Parameter Errors (S02).....	60
3.3 Safety Function Errors (S05).....	62
3.4 Parameter Errors (S51).....	63
3.5 Servo Warnings (S52).....	64
3.6 Safety Function Warnings (S53).....	67
<b>4 MCP Alarms (Y)</b> .....	<b>69</b>
<b>5 System Alarms (Z)</b> .....	<b>85</b>
<b>6 Absolute Position Detection System Alarms (Z7*)</b> .....	<b>99</b>
<b>7 Distance-coded Reference Scale Errors (Z8*)</b> .....	<b>103</b>
<b>8 Emergency Stop Alarms (EMG)</b> .....	<b>105</b>
<b>9 Computer Link Errors (L)</b> .....	<b>109</b>
<b>10 User PLC Alarms (U)</b> .....	<b>111</b>
<b>11 Network Service Errors (N)</b> .....	<b>121</b>
<b>12 Program Errors (P)</b> .....	<b>125</b>
<b>13 Smart Safety Observation Alarm (V)</b> .....	<b>163</b>
13.1 Smart Safety Observation Error (V01/V02/V03/V04/V05/V06/V07) .....	164
13.2 Smart Safety Observation Warning (V50/V51/V52/V53/V54).....	174
<b>14 Multi CPU Errors (A)</b> .....	<b>177</b>

## Parameter

<b>15 User Parameters</b> .....	<b>205</b>
15.1 Machining Parameters.....	206
15.2 Fixed Cycle Parameters .....	217
15.3 Control Parameters 1.....	219
15.4 Control Parameters 2.....	225
15.5 Axis Parameters .....	227
15.6 Ethernet Parameters.....	231
15.7 Barrier Data (for L system only).....	236
15.8 High-accuracy Control Parameters.....	239
15.9 High-accuracy Control Axis Parameters.....	247
15.10 Operation Parameters .....	249
15.11 Machining Condition Selection Parameters.....	263
15.12 Menu Selection Parameters .....	277
<b>16 Machine Parameters</b> .....	<b>279</b>
16.1 Base System Parameters.....	280
16.2 Base Axis Specification Parameters.....	307
16.3 Base Common Parameters .....	311
16.4 Axis Specifications Parameters .....	382

16.5 Zero Point Return Parameters .....	415
16.6 Absolute Position Detection Parameters .....	421
16.7 Servo Parameters .....	423
16.8 Spindle Specification Parameters .....	456
16.9 Spindle Parameters .....	490
16.10 Spindle-type Servo Parameters .....	523
16.11 Rotary Axis Configuration Parameters .....	524
16.12 PLC Timer .....	531
16.13 PLC Integrated Timer .....	532
16.14 PLC Counter .....	533
16.15 PLC Constants .....	534
16.16 PLC Bit Selection .....	535
16.17 Machine Error Compensation Parameters .....	537
16.18 Macro List .....	539
16.19 Position Switches .....	545
16.20 Open Parameters .....	547
16.21 PLC Axis Indexing Parameters .....	548
16.22 Safety Common Parameters .....	558
16.23 Safety Axis Parameters .....	561
16.24 Safety Spindle Parameters .....	567
16.25 Safety I/O Assignment Parameters .....	570
16.26 Multi CPU Parameters .....	572

# Alarm





---

## Operation Errors (M)



<b>M00</b>	<b>Aux ax dog overrun</b>	0001
	<b>Details</b>	
	When executing dog-type reference position, the zero point return speed is too fast or the dog length is too short.	
	<b>Remedy</b>	
	•Lower the zero point return speed or increase the dog length.	
<b>M00</b>	<b>Aux ax R-pnt direction illegal</b>	0003
	<b>Details</b>	
	When executing reference position return, the axis was moved in the opposite of the designated direction.	
	<b>Remedy</b>	
	•Move the axis in the correct direction.	
<b>M00</b>	<b>Aux ax external interlock</b>	0004
	<b>Details</b>	
	The axis interlock function is valid.	
	<b>Remedy</b>	
	•Cancel the interlock signal.	
<b>M00</b>	<b>Aux ax internal interlock</b>	0005
	<b>Details</b>	
	An interlock was established by the servo OFF function.	
	<b>Remedy</b>	
	•Cancel the servo OFF.	
<b>M00</b>	<b>Aux ax soft limit</b>	0007
	<b>Details</b>	
	The stored stroke limit was reached.	
	<b>Remedy</b>	
	Check the stored stroke limit setting and machine position.	
<b>M00</b>	<b>Aux ax R ret invld at abs alm</b>	0024
	<b>Details</b>	
	Reference position return was executed during an absolute position alarm.	
	<b>Remedy</b>	
	•Initialize the absolute position reference point and then fix the absolute position coordinates.	
<b>M00</b>	<b>Aux ax R ret invld at ini</b>	0025
	<b>Details</b>	
	Reference position return was executed during absolute position initial setting.	
	<b>Remedy</b>	
	Initialize the absolute position reference point and then fix the absolute position coordinates.	
<b>M01</b>	<b>Dog overrun</b>	0001
	<b>Details</b>	
	When returning to the reference position, the near-point detection limit switch did not stop over the dog, but overran the dog.	
	<b>Remedy</b>	
	•Increase the length of the near-point dog.	
	•Reduce the reference position return speed.	

<b>M01</b>	<b>Some ax does not pass Z phase</b>	0002
<b>Details</b>		
One of the axes did not pass the Z-phase during the initial reference position return after the power was turned ON.		
<b>Remedy</b>		
<ul style="list-style-type: none"> <li>♦Move the encoder one rotation or more in the opposite direction of the reference position, and repeat reference position return.</li> </ul>		
<b>M01</b>	<b>R-pnt direction illegal</b>	0003
<b>Details</b>		
When manually returning to the reference position, the return direction differs from the axis movement direction selected with the AXIS SELECTION key.		
<b>Remedy</b>		
<ul style="list-style-type: none"> <li>♦The selection of the AXIS SELECTION key's +/- direction is incorrect. The error is canceled by feeding the axis in the correct direction.</li> </ul>		
<b>M01</b>	<b>External interlock axis exists</b>	0004
<b>Details</b>		
The external interlock function has activated (the input signal is "OFF") and one of the axes has entered the interlock state.		
<b>Remedy</b>		
<ul style="list-style-type: none"> <li>♦As the interlock function has activated, release it before resuming operation.</li> <li>♦Correct the sequence on the machine side.</li> <li>♦Check for any broken wires in the "interlock" signal line.</li> </ul>		
<b>M01</b>	<b>Internal interlock axis exists</b>	0005
<b>Details</b>		
The internal interlock state has been entered.		
The axis with absolute encoder has been detached.		
A command for the manual/automatic simultaneous valid axis was issued from the automatic mode.		
The manual speed command was issued while the "tool length measurement 1" signal is ON.		
A travel command has been issued to an inclined axis whose basic axis is in control axis synchronization between part systems.		
Selected an axis other than the 1st axis when the manual speed command was issued.		
A travel command has been issued to an axis stopped by the collision detection function.		
Positioning or interpolation command was issued during the spindle-mode rotary axis control mode.		
<b>Remedy</b>		
<ul style="list-style-type: none"> <li>♦The servo OFF function is valid, so release it first.</li> <li>♦An axis that can be removed has been issued, so perform the correct operations.</li> <li>♦The command is issued in the same direction as the direction where manual skip turned ON, so perform the correct operations.</li> <li>♦During the manual/automatic simultaneous mode, the axis commanded in the automatic mode became the manual operation axis. Turn OFF the "manual/automatic valid" signal for the commanded axis.</li> <li>♦Turn ON the power again, and perform absolute position initialization.</li> <li>♦Turn OFF the "tool length measurement 1" signal to start the program by the manual speed command.</li> <li>♦Cancel the control axis synchronization between part systems, then issue a travel command to the inclined axis.</li> <li>♦Select the 1st axis of each part system when issuing the manual speed command.</li> <li>♦Cancel the collision detection alarm.</li> <li>♦Check the program after cancelling the error by reset.</li> </ul>		
<b>M01</b>	<b>H/W stroke end axis exists</b>	0006
<b>Details</b>		
The stroke end function has activated (the input signal is "OFF") and one of the axes is in the stroke end status.		
<b>Remedy</b>		
<ul style="list-style-type: none"> <li>♦Move the machine manually.</li> <li>♦Check for any broken wires in the "stroke end" signal line.</li> <li>♦Check for any limit switch failure.</li> </ul>		

<b>M01</b>	<b>S/W stroke end axis exists</b>	0007
<b>Details</b>		
The stored stroke limit I, II, IIB or IB function has activated.		
<b>Remedy</b>		
<ul style="list-style-type: none"> <li>•Move the machine manually.</li> <li>•Correct any setting error of the parameters for the stored stroke limit.</li> </ul>		
<b>M01</b>	<b>Chuck/tailstock stroke end ax</b>	0008
<b>Details</b>		
The chuck/tail-stock barrier function turned ON, and an axis entered the stroke end state.		
<b>Remedy</b>		
<ul style="list-style-type: none"> <li>•Reset the alarm with reset, and move the machine in the reverse direction.</li> </ul>		
<b>M01</b>	<b>Ref point return No. invalid</b>	0009
<b>Details</b>		
2nd reference position return was performed before 1st reference position return has been completed.		
<b>Remedy</b>		
<ul style="list-style-type: none"> <li>•Execute 1st reference position return.</li> </ul>		
<b>M01</b>	<b>Illegal op in mid pt sg block</b>	0013
<b>Details</b>		
The operation mode was changed to MDI during single block stop at the middle point of G28/G29/G30.		
<b>Remedy</b>		
<ul style="list-style-type: none"> <li>•Change the operation mode.</li> <li>•Reset to clear the alarm.</li> </ul>		
<b>M01</b>	<b>Sensor signal illegal ON</b>	0019
<b>Details</b>		
The sensor signal was already ON when the tool measurement mode (TLM) signal was validated.		
The sensor signal turned ON when there was no axis movement after the tool measurement mode (TLM) signal was validated.		
The sensor signal turned ON at a position within 100 µm from the final entry start position.		
<b>Remedy</b>		
<ul style="list-style-type: none"> <li>•Turn the tool measurement mode signal input OFF, and move the axis in a safe direction.</li> <li>•Disabling the sensor signal also clears the operation alarm.</li> </ul>		
(Note) When the "tool length measurement 1" signal is disabled, the axis can be moved in either direction. Pay attention to the movement direction.		
<b>M01</b>	<b>Ref point retract invalid</b>	0020
<b>Details</b>		
Reference position retract was performed while the coordinates had not been established.		
<b>Remedy</b>		
<ul style="list-style-type: none"> <li>•Execute reference position return.</li> </ul>		
<b>M01</b>	<b>Tool ofs invld after R-pnt</b>	0021
<b>Details</b>		
Reference position return had been performed during the tool retract and return, which invalidated the tool compensation amount after the reference position return.		
<b>Remedy</b>		
<ul style="list-style-type: none"> <li>•The error is cleared if the operation mode is changed to other than reference position return before the axis performs reference position return.</li> <li>•The error is cleared when the tool return is completed.</li> <li>•The error is cleared if reset 1 is input or the emergency stop button is pushed.</li> </ul>		

## 1 Operation Errors (M)

<b>M01</b>	<b>R-pnt ret invld at abs pos alm</b>	0024
	<b>Details</b>	
	A reference position return signal was enabled during an absolute position detection alarm.	
	<b>Remedy</b>	
	♦Reset the absolute position detection alarm, and then perform the reference position return.	
<b>M01</b>	<b>R-pnt ret invld at zero pt ini</b>	0025
	<b>Details</b>	
	A reference position return signal was input during zero point initialization of the absolute position detection system.	
	<b>Remedy</b>	
	♦Complete the zero point initialization, and then perform reference position return.	
<b>M01</b>	<b>High-accuracy skip disabled</b>	0028
	<b>Details</b>	
	The drive unit's hardware or software does not conform to the high-accuracy skip.	
	<b>Remedy</b>	
	♦The software or hardware does not conform to the function. Contact service center.	
<b>M01</b>	<b>Hi-ac skip coord retrieval err</b>	0029
	<b>Details</b>	
	Failed to retrieve the skip coordinate value from the drive unit.	
	<b>Remedy</b>	
	♦Check the wiring.	
	♦Check the parameters.	
<b>M01</b>	<b>Now skip on</b>	0030
	<b>Details</b>	
	The "skip input" signal remains enabled when the operation has shifted from skip retract to measurement.	
	<b>Remedy</b>	
	♦Increase the skip retract amount.	
<b>M01</b>	<b>No skip</b>	0031
	<b>Details</b>	
	Even though the 1st skip was to the correct position, the 2nd skip could not be found.	
	<b>Remedy</b>	
	♦Check whether the measurement target has moved.	
<b>M01</b>	<b>Rtn dir err in manual measure</b>	0033
	<b>Details</b>	
	Return direction in manual measurement is the opposite of the parameter setting.	
	<b>Remedy</b>	
	♦Check the setting of the parameter "#2169 Rtn dir err in manual measure" (Return direction in manual measurement).	
	♦Move the axis manually in the direction to a safe position, then reset.	
<b>M01</b>	<b>No specifications</b>	0036
	<b>Details</b>	
	The specification is not supported.	
	<b>Remedy</b>	
	♦Check the specifications.	

<b>M01</b>	<b>Chopping axis R-pnt incomplete</b>	0050
<b>Details</b>		
Chopping mode has been entered while the chopping axis has not completed reference position return. All axes interlock has been applied.		
<b>Remedy</b>		
•Reset the NC or disable the "chopping" signal, and then carry out the reference position return.		
<b>M01</b>	<b>Synchronous error excessive</b>	0051
<b>Details</b>		
The synchronization error of the master and slave axes exceeded the allowable value under synchronous control. A deviation exceeding the synchronization error limit value was found with the synchronization deviation detection.		
<b>Remedy</b>		
•Select the correction mode and move one of the axes in the direction in which the errors are reduced.		
•Check the parameter "#2024 synerr".		
•Increase the allowable value or reset it to "0" (check disabled).		
•When using simple C-axis synchronous control, set the contents of the R2589 register to "0".		
<b>M01</b>	<b>No spindle select signal</b>	0053
<b>Details</b>		
Synchronous tapping command was issued when the spindle select signals (SWS) for all spindles were OFF in the multiple-spindle control II.		
<b>Remedy</b>		
•Turn ON the spindle select signal (SWS) responding to the tapping spindle before performing the synchronous tapping command.		
<b>M01</b>	<b>No spindle serial connection</b>	0054
<b>Details</b>		
Synchronous tapping command was issued when the spindle that the spindle select signal (SWS) was ON was not serially connected in the multiple-spindle control II.		
<b>Remedy</b>		
•Make sure the spindle select signal (SWS) for the responding spindle is ON.		
•Consider the machine construction when issuing the command.		
<b>M01</b>	<b>Spindle fwd/rvs run para err</b>	0055
<b>Details</b>		
Asynchronous tapping command was issued when M code of the spindle forward/reverse run command, set by the parameter "#3028 sprcmm", was one of the followings in the multiple-spindle control II.		
•M0, M1, M2, M30, M98, M99, or M198		
•M code No. that commands to enable/disable the "macro interrupt" signal		
<b>Remedy</b>		
•Correct the parameter "#3028 sprcmm" (Tap cycle spindle forward run/reverse run M command) setting.		
<b>M01</b>	<b>Tap pitch/thread number error</b>	0056
<b>Details</b>		
The command for the pitch or the number of threads is not correct in the synchronous tapping command of the multiple-spindle control II.		
The pitch is too small for the spindle rotation speed.		
Thread number is too large for the spindle rotation speed.		
<b>Remedy</b>		
•Correct the pitch, number of threads or rotation speed of the tapping spindle.		

<b>M01</b>	<b>Wait for tap retract</b>	0057
<b>Details</b>		
The axis travel command is interlocked as the tap retract is being enabled.		
<b>Remedy</b>		
<ul style="list-style-type: none"> <li>♦If tapping is necessary, perform tapping retract in advance. However, tapping retract is not allowed during cycle start operation. Carry out tapping retract after resetting.</li> <li>♦If tapping is not necessary, cancel the tap retract enabled condition by the tap retract enabled cancel signal.</li> </ul>		
<b>M01</b>	<b>Handle ratio too large</b>	0060
<b>Details</b>		
The handle ratio is too large for the handle feed clamp speed. (The handle feed clamp speed changes according to the rapid traverse rate, external feedrate, maximum speed outside the soft limit range and etc. (or external deceleration speed when external deceleration is valid))		
Too large handle ratio means the ratio with which the machine is unable to move the distance of [iunit * handle ratio] within 0.1ms at the clamp speed.		
Example)		
When iunit=B (0.001mm) and clamp speed cs (mm/min)		
The operation error (M01 0060) will occur if		
ratio $M > cs/60(s) * 0.1(ms) / 0.001(mm) = cs * 10/6$ .		
<b>Remedy</b>		
♦Change the settings of the handle feed clamp speed or the handle ratio.		
<b>M01</b>	<b>R-pos offset value illegal</b>	0065
<b>Details</b>		
At the start of reference position initial setting, the parameter "#2034 rpfofs" (Distance-coded reference position detection offset) is not set to "0".		
<b>Remedy</b>		
♦Set the parameter "#2034 rpfofs" to "0", then turn the power ON again to perform the reference position initial setting.		
<b>M01</b>	<b>R-pos scan distance exceeded</b>	0066
<b>Details</b>		
Reference position could not be established within the maximum scan distance.		
<b>Remedy</b>		
<ul style="list-style-type: none"> <li>♦Check the scale to see if it has dirt or damage.</li> <li>♦Check if the servo drive unit supports this function.</li> </ul>		
<b>M01</b>	<b>Illegal op in wk instl err cmp</b>	0070
<b>Details</b>		
One of the following operations was attempted during workpiece installation error compensation.		
<ul style="list-style-type: none"> <li>♦Manual interruption</li> <li>♦Automatic operation handle interruption</li> <li>♦MDI interruption</li> <li>♦PLC interruption</li> </ul>		
<b>Remedy</b>		
♦Return the operation mode to the original mode to remove the cause. During workpiece installation error compensation, manual interruption, automatic operation handle interruption, MDI interruption, PLC interruption, etc. is not allowed.		
<b>M01</b>	<b>High-acc/Non-intrpl in hyp ax</b>	0090
<b>Details</b>		
Under hypothetical linear axis control, high-accuracy control was commanded during hypothetical axis command mode, or non-interpolation mode was enabled.		
<b>Remedy</b>		
♦Correct the parameters "#1086 G0Intp" (G00 non-interpolation) and "#1205 G0bdcc" (Acceleration and deceleration before G0 interpolation).		

<b>M01</b>	<b>Hyp. linear axis: illegal axis</b>	0091
<b>Details</b>		
Under hypothetical linear axis control, a command was issued to an actual axis that lies in the hypothetical plane during hypothetical axis command mode, or a command was issued to a hypothetical axis during actual axis command mode.		
<b>Remedy</b>		
•Change the commanded axis or the command mode.		
<b>M01</b>	<b>Hyp. axis out of movable range</b>	0092
<b>Details</b>		
An attempt was made to move the hypothetical axis outside the movable range.		
<b>Remedy</b>		
Correct the following parameters:		
•"#12015 v_dist" (Hypothetical axis tool length)		
•"#12016 v_ori" (Hypothetical axis machine zero)		
•"#12020 r_lim+" (Actual axis movable range (+))		
•"#12021 r_lim-" (Actual axis movable range (-))		
<b>M01</b>	<b>Illegal op in dia/rad select</b>	0095
<b>Details</b>		
An axis used in the following functions is also used as an axis to perform diameter/radius designation selection.		
•Chopping		
•Synchronization control		
Or diameter/radius designation selection (G10.9) was issued to the axis in the above mode.		
<b>Remedy</b>		
•Check the program.		
•Do not carry out the following functions using an axis to perform diameter/radius designation selection.		
- Chopping		
- Synchronization control		
<b>M01</b>	<b>No operation mode</b>	0101
<b>Details</b>		
[No operation mode]		
No operation mode		
[Aux ax no operation mode]		
The operation mode is not designated, or the operation mode was changed during axis movement.		
<b>Remedy</b>		
[No operation mode]		
•Check for any broken wires in the input mode signal wire.		
•Check for any failure of the MODE SELECT switch.		
•Correct the sequence program.		
[Aux ax no operation mode]		
•Correctly designate the operation mode.		
<b>M01</b>	<b>Cutting override zero</b>	0102
<b>Details</b>		
The "cutting feed override" switch on the machine operation panel is set to "0".		
The override was set to "0" during a single block stop.		
<b>Remedy</b>		
•Set the "cutting feed override" switch to a value other than "0" to clear the error.		
•If the "cutting feed override" switch has been set to a value other than "0", check for any short circuit in the signal line.		
•Correct the sequence program.		

<b>M01</b>	<b>External feed rate zero</b>	0103
<b>Details</b>		
[External feed rate zero]		
The MANUAL FEEDRATE switch on the machine operation panel is set to zero when the machine is in the jog mode or automatic dry run mode.		
The "Manual feedrate B speed" signal is set to zero during the jog mode when Manual feedrate B is valid.		
The "Each axis manual feedrate B speed" is set to zero during the jog mode when Each axis manual feedrate B is valid.		
[Aux ax feedrate 0]		
The feedrate set in the operation parameter is zero.		
Or the override is enabled but is set to zero.		
<b>Remedy</b>		
[External feed rate zero]		
<ul style="list-style-type: none"> <li>♦Set the MANUAL FEEDRATE switch to a value other than "0" to release the error.</li> <li>♦If the MANUAL FEEDRATE switch has been set to a value other than "0" check for any short circuit in the signal line.</li> <li>♦Correct the sequence program.</li> </ul>		
[Aux ax feedrate 0]		
<ul style="list-style-type: none"> <li>♦Set a value other than zero in the feedrate setting or override value.</li> </ul>		
<b>M01</b>	<b>F 1-digit feed rate zero</b>	0104
<b>Details</b>		
The F1-digit feedrate has been set to "0" when the F1-digit feed command was executed.		
<b>Remedy</b>		
<ul style="list-style-type: none"> <li>♦Set the F1-digit feedrate (the parameter "#1185 spd_F1" (F1 digit feedrate F1) to "#1189 spd_F5" (F1 digit feedrate F5)).</li> </ul>		
<b>M01</b>	<b>Spindle stop</b>	0105
<b>Details</b>		
The spindle stopped during the synchronous feed/thread cutting command.		
<b>Remedy</b>		
<ul style="list-style-type: none"> <li>♦Rotate the spindle.</li> <li>♦If the workpiece is not being cut, start dry run.</li> <li>♦Check for any broken wire in the spindle encoder cable.</li> <li>♦Check the connections for the spindle encoder connectors.</li> <li>♦Check the spindle encoder pulse.</li> <li>♦Correct the program. (commands and addresses)</li> </ul>		
<b>M01</b>	<b>Handle feed ax No. illegal</b>	0106
<b>Details</b>		
The axis, designated at handle feed, is out of specifications.		
No axis has been selected for handle feed.		
Multiple axes in a part system are allocated to a handle.		
<b>Remedy</b>		
<ul style="list-style-type: none"> <li>♦Check for any broken wires in the handle feed axis selection signal line.</li> <li>♦Correct the sequence program.</li> <li>♦Check the number of axes in the specifications.</li> <li>♦Check the axis allocation to the handle.</li> </ul>		
<b>M01</b>	<b>Spindle rotation speed over</b>	0107
<b>Details</b>		
Spindle rotation speed exceeded the axis clamp speed during the thread cutting command.		
<b>Remedy</b>		
<ul style="list-style-type: none"> <li>♦Lower the commanded rotation speed.</li> </ul>		



<b>M01</b>	<b>Fixed pnt mode feed ax illegal</b>	0108
	<b>Details</b>	
	The axis, designated in the manual arbitrary feed, is out of specifications. The feedrate in manual arbitrary feed mode is illegal.	
	<b>Remedy</b>	
	•Check for any broken wires in the axis selection signal line or the feedrate line for the manual arbitrary feed mode. •Check the specifications for the manual arbitrary feed mode.	
<b>M01</b>	<b>Block start interlock</b>	0109
	<b>Details</b>	
	An interlock signal has been input to lock the block start.	
	<b>Remedy</b>	
	•Correct the sequence program.	
<b>M01</b>	<b>Cutting block start interlock</b>	0110
	<b>Details</b>	
	An interlock signal has been input to lock the cutting block start.	
	<b>Remedy</b>	
	•Correct the sequence program.	
<b>M01</b>	<b>Restart switch ON</b>	0111
	<b>Details</b>	
	Restart switch has been turned ON and manual mode has been selected before the restart search is completed.	
	<b>Remedy</b>	
	•Search the block to restart. •Turn the restart switch OFF.	
<b>M01</b>	<b>Program check mode</b>	0112
	<b>Details</b>	
	The cycle start button was pressed during program check or in program check mode.	
	<b>Remedy</b>	
	•Press the reset button to cancel the program check mode.	
<b>M01</b>	<b>Cycle st. in buffer correct</b>	0113
	<b>Details</b>	
	The cycle start button was pressed during buffer correction.	
	<b>Remedy</b>	
	•Press the cycle start button after the buffer correction is completed.	
<b>M01</b>	<b>In reset process</b>	0115
	<b>Details</b>	
	The cycle start button was pressed during resetting or tape rewinding.	
	<b>Remedy</b>	
	•When rewinding the tape, wait for the winding to end, or press the reset button to stop the winding, and then press the cycle start button. •During resetting, wait for the resetting to end, and then press the automatic start button.	
<b>M01</b>	<b>Playback not possible</b>	0117
	<b>Details</b>	
	The playback switch was turned ON during editing.	
	<b>Remedy</b>	
	•Cancel the editing by pressing the input or previous screen key before turning ON the playback switch.	

<b>M01</b>	<b>Turn stop in normal line cntrl</b>	0118
<b>Details</b>		
<p>The turning angle at the block joint exceeded the limit during normal line control.            In normal line control type I:            The parameter "#1523 C_feed" (Normal line control axis turning speed) has not been set.            In normal line control type II:            When turning in the inside of the arc, the set value for the parameter "#8041 C-rot. R" is larger than the arc radius.</p>		
<b>Remedy</b>		
<ul style="list-style-type: none"> <li>♦Correct the program.</li> <li>♦Correct the parameter "#1523 C_feed" (Normal line control axis turning speed) setting.</li> <li>♦Correct the parameter "#8041 C-rot. R" setting.</li> </ul>		
<b>M01</b>	<b>Reverse run impossible</b>	0119
<b>Details</b>		
<p>Any of the following conditions are occurring.</p> <ol style="list-style-type: none"> <li>a) There is no block to run backward</li> <li>b) Eight blocks without a travel command continued</li> </ol>		
<b>Remedy</b>		
<ul style="list-style-type: none"> <li>♦Execute forward run to clear the alarm.</li> <li>♦Reset to clear the alarm.</li> </ul>		
<b>M01</b>	<b>In synchronous correction mode</b>	0120
<b>Details</b>		
<p>The synchronous correction mode switch was pressed in non-handle mode.</p>		
<b>Remedy</b>		
<ul style="list-style-type: none"> <li>♦Select the handle or manual arbitrary feed mode.</li> <li>♦Turn OFF the correction mode switch.</li> </ul>		
<b>M01</b>	<b>No synchronous control option</b>	0121
<b>Details</b>		
<p>The synchronous control operation method was set (with R2589) while no synchronous control option was provided.</p>		
<b>Remedy</b>		
<ul style="list-style-type: none"> <li>♦Set "0" for "synchronous control operation method".</li> </ul>		
<b>M01</b>	<b>Computer link B not possible</b>	0123
<b>Details</b>		
<p>Cycle start was attempted before resetting was completed.            Computer link B operation was attempted at the 2nd or further part system in a multi-part system.</p>		
<b>Remedy</b>		
<ul style="list-style-type: none"> <li>♦Perform the cycle start after resetting has been completed.</li> <li>♦Set "#8109 HOST LINK" to "0" and then set to "1" before performing the cycle start.</li> <li>♦Computer link B operation cannot be performed at the 2nd or further part system in a multi-part system.</li> </ul>		
<b>M01</b>	<b>X/Z axes simultaneous prohibit</b>	0124
<b>Details</b>		
<p>The basic axis corresponding to the inclined axis was started simultaneously in the manual mode while the inclined axis control was valid.</p>		
<b>Remedy</b>		
<ul style="list-style-type: none"> <li>♦Turn the inclined axis and basic axis start OFF for both axes. (This is also applied for manual/automatic simultaneous start.)</li> <li>♦Disable the basic axis compensation, or command it to axes one by one.</li> </ul>		

<b>M01</b>	<b>Rapid override zero</b>	0125
<b>Details</b>		
<ul style="list-style-type: none"> <li>•The RAPID TRAVERSE OVERRIDE switch on the machine operation panel is set to "0".</li> <li>•Override was set to "0" during single block stop.</li> </ul>		
<b>Remedy</b>		
<ul style="list-style-type: none"> <li>•Set the RAPID TRAVERSE OVERRIDE switch to a value other than "0" to clear the error.</li> <li>•If the RAPID TRAVERSE OVERRIDE switch has been set to a value other than "0", check for any short circuit in the signal line.</li> <li>•Correct the sequence program.</li> </ul>		
<b>M01</b>	<b>Program restart machine lock</b>	0126
<b>Details</b>		
Machine lock was applied on the return axis being manually returned to the restart position.		
<b>Remedy</b>		
<ul style="list-style-type: none"> <li>•Cancel the machine lock and resume the operation.</li> </ul>		
<b>M01</b>	<b>Rot axis parameter error</b>	0127
<b>Details</b>		
Orthogonal coordinate axis name does not exist.		
Rotary axis name does not exist.		
A duplicate name is used for the designated orthogonal coordinate axis.		
The number of axes that were selected to change tool length compensation along the tool axis amount exceeds the maximum number of axes.		
The designated orthogonal coordinate axis name is the same as the rotary axis name.		
<b>Remedy</b>		
<ul style="list-style-type: none"> <li>•Correct the rotary axis configuration parameters.</li> </ul>		
<b>M01</b>	<b>Restart pos return incomplete</b>	0128
<b>Details</b>		
Cycle start was performed with an axis whose return to the restart position was not complete.		
<b>Remedy</b>		
<ul style="list-style-type: none"> <li>•Perform restart position return manually.</li> <li>•Validate the parameter "#1302 AutoRP" (Automatic return by program restart), then execute cycle start.</li> </ul>		
<b>M01</b>	<b>PLC interruption impossible</b>	0129
<b>Details</b>		
After the cycle start, the "PLC interrupt" signal was turned ON during buffer correction, program restart, arbitrary reverse run, tool retract and return, high-speed high-accuracy control II, NURBS interpolation or single block stop at the middle point of G28/G29/G30.		
<b>Remedy</b>		
<ul style="list-style-type: none"> <li>•By turning OFF the "PLC interrupt" signal, or by resetting the NC the error can be cancelled.</li> </ul>		
<b>M01</b>	<b>Restart posn return disabled</b>	0130
<b>Details</b>		
Restart position return was attempted in a mode where the return is disabled.		
<b>Remedy</b>		
<ul style="list-style-type: none"> <li>•Correct the program restart position.</li> </ul>		
<b>M01</b>	<b>Zero point return interruption</b>	0131
<b>Details</b>		
Compound type fixed cycle program was interrupted with manual zero point return, and cycle start was carried out without carrying out reset.		
<b>Remedy</b>		
<ul style="list-style-type: none"> <li>•Cancel the program execution by reset.</li> </ul>		

<b>M01</b>	<b>Excessive no. of reverse block</b>	0133
<b>Details</b>		
During the reverse run in arbitrary reverse run, any one of the part systems reverse-ran for 20 blocks.		
<b>Remedy</b>		
♦This error is cancelled by forward run.		
<b>M01</b>	<b>Illegal mode in prg check mode</b>	0134
<b>Details</b>		
Any of the following modes has been turned ON during the manual arbitrary reverse run mode.		
♦MDI interruption mode		
♦Manual/automatic simultaneous valid (MAE1 to 8)		
♦Arbitrary feed mode (PTP)		
♦Arbitrary reverse control mode (RVMD)		
♦Manual speed command enabled		
♦High-speed simple program check mode (SMLK)		
<b>Remedy</b>		
♦The error can be cancelled by turning OFF the error-causing mode.		
<b>M01</b>	<b>Too many active axes per sys</b>	0135
<b>Details</b>		
High-accuracy control has been executed in a part system which has 9 or more enabled control axes, except for a slave or synchronized axis.		
<b>Remedy</b>		
♦Reduce the number of enabled control axes (except for a slave axis and synchronized axis) of the part system to 8 or less through synchronous control, control axis synchronization between part systems, or mixed control before executing high-accuracy control.		
<b>M01</b>	<b>Pre-intrpl variable accel err</b>	0136
<b>Details</b>		
♦The parameter "#12060 VblAccPreInt" (Variable-acceleration pre-interpolation acceleration/deceleration ON) is set to "1" and the parameter "#8090 SSS ON" is set to "0".		
<b>Remedy</b>		
♦To enable the variable acceleration pre-interpolation acceleration/deceleration, set the parameter "#8090 SSS ON" to "1".		
To disable the variable acceleration pre-interpolation acceleration/deceleration, set the parameter "#12060 VblAccPreInt" to "0".		
<b>M01</b>	<b>Unable to start automatic mode</b>	0137
<b>Details</b>		
♦Although start of automatic operation is not allowed after a machine groupwise alarm stop ("#1472 mgralmrestart=0), start of automatic operation has been attempted after the said alarm stop.		
♦The cycle operation is started with the guide bushing spindle synchronization related spindle is not being set.		
♦The cycle operation is started while the "G/B spindle synchronization: temporary cancel" signal is turned ON.		
<b>Remedy</b>		
♦Remove the cause of the stop by alarm.		
♦Set the parameter "#1472 mgralmrestart" (Allowing automatic operation to start after machine groupwise alarm stop) to "1".		
♦Check the parameter "#3074 GBsp".		
♦Turning OFF the "G/B spindle synchronization: temporary cancel" signal before starting the cycle operation.		

<b>M01</b>	<b>Tool data sorting in progress</b>	0138
	<b>Details</b>	
	Cycle start or graphic check has been attempted during sorting of tool management data.	
	<b>Remedy</b>	
	<ul style="list-style-type: none"> <li>•Execute cycle start after the tool data sorting is completed.</li> <li>•Execute graphic check after the tool data sorting is completed.</li> </ul>	
<b>M01</b>	<b>Tolerance control invalid</b>	0139
	<b>Details</b>	
	The parameter "#12066 Tolerance ctrl ON" is set to "1", although "#8090 SSS ON" is "0".	
	<b>Remedy</b>	
	<ul style="list-style-type: none"> <li>•To enable the tolerance control, set "#8090 SSS ON" to "1".</li> <li>To disable the tolerance control, set "#12066 Tolerance ctrl ON" to "0".</li> </ul>	
<b>M01</b>	<b>Ill manualmode select in 3Dcnv</b>	0145
	<b>Details</b>	
	The following unselectable manual mode was selected during 3-dimensional coordinate conversion.	
	<ul style="list-style-type: none"> <li>•manual reference position return</li> </ul>	
	<b>Remedy</b>	
	<ul style="list-style-type: none"> <li>•Cancel the 3-dimensional coordinate conversion modal.</li> </ul>	
<b>M01</b>	<b>Start err in PRM rot manu feed</b>	0146
	<b>Details</b>	
	Axis start has been attempted with any of the following operations while the coordinate rotation by parameter for manual feed is enabled.	
	<ul style="list-style-type: none"> <li>•Tool retract and return</li> <li>•Manual tool length measurement</li> <li>•Manual skip</li> </ul>	
	<b>Remedy</b>	
	<ul style="list-style-type: none"> <li>•Turn OFF the "Coordinate rotation by parameter: Coordinate switch for manual feed" signal.</li> </ul>	
<b>M01</b>	<b>Multiaxes in RRM rot manu feed</b>	0147
	<b>Details</b>	
	Two or more of the three basic axes were started at a time for the coordinate rotation by parameter for manual feed.	
	<b>Remedy</b>	
	<ul style="list-style-type: none"> <li>•Disable the coordinate rotation by parameter for manual feed or start one axis at a time.</li> </ul>	
<b>M01</b>	<b>Hypoth linear ax ctrl invalid</b>	0148
	<b>Details</b>	
	"Hypothetical axis command mode" signal has been turned ON while Hypothetical linear axis control is disabled.	
	<b>Remedy</b>	
	<ul style="list-style-type: none"> <li>•Enable Hypothetical linear axis control before the "Hypothetical axis command mode" signal is turned ON.</li> </ul>	
<b>M01</b>	<b>Chopping override zero</b>	0150
	<b>Details</b>	
	The override became "0" in the chopping operation.	
	<b>Remedy</b>	
	<ul style="list-style-type: none"> <li>•Check the chopping override (R2503).</li> <li>•Check the rapid traverse override (R2502).</li> </ul>	

<b>M01</b>	<b>Command axis chopping axis</b>	0151
<b>Details</b>		
A chopping axis movement command was issued from the program during the chopping mode. (This alarm will not occur for the command with the movement amount "0".) (All axes interlock state will be applied.)		
<b>Remedy</b>		
♦Press the reset button or turn OFF the "chopping" signal. When the "chopping" signal is turned OFF, the axis returns to the reference position and performs the movement command in the program.		
<b>M01</b>	<b>Bottom dead center pos. zero</b>	0153
<b>Details</b>		
The bottom dead center position is set to the same position as the upper dead center position.		
<b>Remedy</b>		
♦Correct the bottom dead center position.		
<b>M01</b>	<b>Chopping disable for handle ax</b>	0154
<b>Details</b>		
Chopping has been attempted while the chopping axis is selected as the handle axis.		
<b>Remedy</b>		
♦Select an axis other than the chopping axis as the handle axis, or start chopping after changing the mode to the other mode.		
<b>M01</b>	<b>Dir cmnd mode invalid</b>	0157
<b>Details</b>		
♦The drive unit's software or hardware does not conform to the direct command mode. ♦Inclined axis control is active. ♦Control axis synchronization between part systems is active. ♦Control axis superimposition was activated during direct command mode.		
<b>Remedy</b>		
♦The software or hardware does not conform to the function. Contact service center. ♦Turn the inclined axis control valid signal OFF. ♦Turn the synchronous control request signal OFF. ♦Turn the superimposition control request signal OFF.		
<b>M01</b>	<b>Dir cmnd mode restart invalid</b>	0158
<b>Details</b>		
♦Cycle start was carried out without reset after the retract in direct command mode.		
<b>Remedy</b>		
♦Finish the machining for now by resetting the NC.		
<b>M01</b>	<b>No speed set out of soft limit</b>	0160
<b>Details</b>		
[No speed set out of soft limit]		
The axis, without any maximum speed outside of the soft limit range set, was returned from the outside of the soft limit range.		
[Aux ax sta No. illegal]		
A station No. exceeding the No. of indexed divisions was designated.		
<b>Remedy</b>		
[No speed set out of soft limit]		
♦Correct the parameter "#2021 out_f" (Maximum speed outside soft limit range) setting. ♦Correct the soft limit range (with the parameter "#2013 OT-" (Soft limit I-) and "#2014 OT+" (Soft limit I+)).		
[Aux ax sta No. illegal]		
♦Correctly designate the station No.		

<b>M01</b>	<b>Aux ax R-pnt ret incomplete</b>	0161
	<b>Details</b>	
	Automatic/manual operation was started before reference position return was executed with the incremental system.	
	<b>Remedy</b>	
	•Execute the reference position return.	
<b>M01</b>	<b>Aux abs position initializing</b>	0162
	<b>Details</b>	
	The start signal was input while initializing the absolute position reference point.	
	<b>Remedy</b>	
	•Complete the absolute position reference point initialization.	
<b>M01</b>	<b>Aux ax abs position error</b>	0163
	<b>Details</b>	
	The start signal was input during an absolute position alarm.	
	<b>Remedy</b>	
	•Initialize the absolute position reference point and then fix the absolute position coordinates.	
<b>M01</b>	<b>Aux ax arbitrary positioning</b>	0164
	<b>Details</b>	
	The manual operation mode was started during the random positioning mode.	
	<b>Remedy</b>	
	•Turn the random positioning mode OFF before switching to the manual operation mode.	
<b>M01</b>	<b>Aux uneven index sta No. ilgl</b>	0165
	<b>Details</b>	
	The commanded station No. was higher than 20 or the number of indexing stations during uneven indexing. The station No.0 was specified during uneven indexing.	
	<b>Remedy</b>	
	•Check the commanded station No. and the parameter "#12801 aux_station" setting.	
<b>M01</b>	<b>Aux axis changeover error</b>	0166
	<b>Details</b>	
	One of the following attempts was made on an axis that is switchable between NC axis and auxiliary axis.	
	•A command intended for an NC axis in manual mode was issued to an auxiliary axis.	
	•NC axis control select signal was turned OFF while the NC axis was in motion.	
	•NC axis control select signal was turned ON while the auxiliary axis was in motion.	
	<b>Remedy</b>	
	•If you wish to issue a command intended for an NC axis in manual mode, turn ON the NC axis control select signal so as to set the axis as an NC axis.	
	•Do not change NC axis control select signal while the axis is in motion.	
<b>M01</b>	<b>Aux ax torque limit value zero</b>	0167
	<b>Details</b>	
	Torque limit value of the parameter group to use is "0".	
	<b>Remedy</b>	
	•Check the torque limit value of the parameter group to use (#12814 aux_TL1, #12824 aux_TL2, #12834 aux_TL3, or #12844 aux_TL4).	
<b>M01</b>	<b>Ill. op during T tip control</b>	0170
	<b>Details</b>	
	Illegal operation was attempted during tool tip center control.	
	<b>Remedy</b>	
	•Change the operation mode to the previous one and restart.	

<b>M01</b>	<b>Illegal op in spline interpol2</b>	0180
<b>Details</b>		
Any of the following operations was performed during spline interpolation 2.		
<ul style="list-style-type: none"> <li>♦Change to manual mode</li> <li>♦Change to MDI mode</li> <li>♦PLC interruption</li> </ul>		
<b>Remedy</b>		
♦Return to the original operation mode, and then remove the error cause.		
<b>M01</b>	<b>Illegal OP in tilted face cut</b>	0185
<b>Details</b>		
Any of the following illegal operations was attempted during inclined surface machining mode.		
<ul style="list-style-type: none"> <li>♦Manual interrupt</li> <li>♦Handle interrupt in automatic operation</li> <li>♦MDI interrupt</li> <li>♦PLC interrupt</li> <li>♦Arbitrary reverse run</li> </ul>		
<b>Remedy</b>		
Switch the operation mode back to the previous to remove the cause of this failure.		
♦During inclined surface machining mode, it's impossible to perform manual interrupt, handle interrupt in automatic operation, MDI interrupt, PLC interrupt, etc.		
<b>M01</b>	<b>5-axis control config. error</b>	0186
<b>Details</b>		
The operation you input cannot be executed under the axis configuration of the part system.		
<ul style="list-style-type: none"> <li>♦3D manual feed was attempted.</li> <li>♦The rotation center error compensation has been turned ON.</li> <li>♦The rotary axis is set to the spindle mode of the spindle position control.</li> </ul>		
<b>Remedy</b>		
<ul style="list-style-type: none"> <li>♦Check the rotary axis configuration parameters.</li> <li>♦Correct the axis configuration of the part system.</li> <li>♦Press the reset button to cancel this alarm.</li> </ul>		
<b>M01</b>	<b>Rotary axis para unswitchable</b>	0187
<b>Details</b>		
The rotary axis configuration parameter switch request signal has turned ON for a part system where any of the following modes is active.		
<ul style="list-style-type: none"> <li>♦Tool center point control mode</li> <li>♦Inclined surface machining mode</li> <li>♦Workpiece installation error compensation mode</li> <li>♦Tool axis direction tool length compensation mode</li> <li>♦Simple inclined surface machining mode</li> <li>♦3D radius compensation mode</li> <li>♦3D manual feed</li> <li>♦Tool handle feed &amp; interruption</li> <li>♦R-Navi mode</li> </ul>		
<b>Remedy</b>		
♦Cancel the alarm by NC reset or by turning OFF the rotary axis configuration parameter switch request signal.		
<b>M01</b>	<b>Interference check disabled</b>	0200
<b>Details</b>		
3D machine interference check is disabled. This alarm is output to NC alarm 5.		
<b>Remedy</b>		
<ul style="list-style-type: none"> <li>♦Enable all the interference check settings.</li> <li>♦If there is any axis which has not completed zero point return, establish the zero point first.</li> </ul>		



<b>M01</b>	<b>Machine interference 1</b>	0201
<b>Details</b>		
It was judged that an interference occurred in the No.1 step interference check and caused a deceleration stop. When machine interference is detected, the interfered part is highlighted (yellow/red) and the part's name is displayed on the 3D monitor's model display.		
<b>Remedy</b>		
<ul style="list-style-type: none"> <li>•Move the axis in a direction which does not cause interference.</li> <li>•Press RESET to cancel the alarm.</li> <li>•(In manual operation) You can move the axis in the same travel direction as before the interference. But the axis movement is done using the 2nd step interference check distance.</li> </ul>		
<b>M01</b>	<b>Machine interference 2</b>	0202
<b>Details</b>		
It was judged that an interference occurred in the No.2 step interference check and caused a deceleration stop. When machine interference is detected, the interfered part is highlighted (red) and the part's name is displayed on the 3D monitor's model display.		
<b>Remedy</b>		
<ul style="list-style-type: none"> <li>•Move the axis in a direction which doesn't cause interference.</li> <li>•Press RESET to cancel the alarm.</li> </ul>		
<b>M01</b>	<b>Tool interfere. check disabled</b>	0205
<b>Details</b>		
Tool interference check has been disabled. This alarm is output to the NC alarm 5.		
<b>Remedy</b>		
<ul style="list-style-type: none"> <li>•Turn ON the [Tool check] menu of 3D monitor.</li> <li>•Set the tool data.</li> <li>•If you prevent an alarm from being output while the tool interference check is disabled, set "0" in "#11100 3D_MChk_ToolAlm".</li> </ul>		
<b>M01</b>	<b>Too many simul. control axes</b>	0211
<b>Details</b>		
The given command has caused any axis other than those commanded to move. So the total number of axes to move has exceeded the maximum number of simultaneous contour control axes.		
<b>Remedy</b>		
<ul style="list-style-type: none"> <li>•Check the maximum number of simultaneous contour control axes of your NC.</li> <li>•Check the machining program to make sure the total number of axes to move will not exceed the maximum number of simultaneous contour control axes.</li> </ul>		
<b>M01</b>	<b>Changing prg format disabled</b>	0215
<b>Details</b>		
The PFCHR signal has been switched (from ON to OFF or OFF to ON) during automatic operation.		
<b>Remedy</b>		
<ul style="list-style-type: none"> <li>•Use G188 to change the program format during automatic operation.</li> <li>* The warning display is cancelled by changing PFCHR back to the previous state.</li> </ul>		
<b>M01</b>	<b>Multi ax for 3D manual feed</b>	0230
<b>Details</b>		
More than one axis was designated in manual mode while the 3-dimensional manual feed was valid.		
<b>Remedy</b>		
<ul style="list-style-type: none"> <li>•Command the manual feed to each axis one by one.</li> </ul>		

<b>M01</b>	<b>3D manual feed coord sys err</b>	0231
<b>Details</b>		
<ul style="list-style-type: none"> <li>♦More than one of the three bits for selecting hypothetical coordinate system was turned ON.</li> <li>♦Virtual coordinate system was selected while the 3-dimensional manual feed was invalidated by the parameter setting.</li> <li>♦The manual tool length measurement or workpiece position measurement is being attempted.</li> </ul>		
<b>Remedy</b>		
<ul style="list-style-type: none"> <li>♦Check the sequence program.</li> <li>♦Enable 3-dimensional tool radius compensation (set the parameter "#7912 NO_MANUAL" to "0").</li> <li>♦Finish the manual tool length measurement or workpiece position measurement.</li> </ul>		
<b>M01</b>	<b>Illegal op in 3D tool R comp</b>	0232
<b>Details</b>		
An illegal operation (such as manual interrupt) was attempted during 3-dimensional tool radius compensation (tool vertical direction compensation).		
<b>Remedy</b>		
<ul style="list-style-type: none"> <li>♦Operations such as manual interrupt are disabled while 3-dimensional tool radius compensation (tool vertical direction compensation) is being performed.</li> </ul>		
<b>M01</b>	<b>Coord select w/o 3D man. Feed</b>	0233
<b>Details</b>		
Hypothetical coordinate system has been selected although 3D manual feed is not included in the specifications.		
<b>Remedy</b>		
Turn OFF all the 3D manual feed coordinate system selection signals (including MJCT).		
<b>M01</b>	<b>No spec: Rot center error comp</b>	0240
<b>Details</b>		
No option of rotation center error compensation is found.		
<b>Remedy</b>		
<ul style="list-style-type: none"> <li>♦Check the specifications.</li> </ul>		
<b>M01</b>	<b>Rot center err comp excessive</b>	0241
<b>Details</b>		
<ul style="list-style-type: none"> <li>♦The calculated compensation amount was excessive, thus the amount was clamped to +/- 1mm.</li> </ul>		
<b>Remedy</b>		
<ul style="list-style-type: none"> <li>♦Check the values of the position deviation and the angle deviation.</li> </ul>		
<b>M01</b>	<b>Unable to start measuring err</b>	0245
<b>Details</b>		
You executed cycle start while measurement of rotation center error or workpiece installation error is invalid.		
<b>Remedy</b>		
Execute cycle start for one part system that is ready for measurement. Activate memory mode before executing cycle start.		
<b>M01</b>	<b>Invalid op mode in err measure</b>	0246
<b>Details</b>		
You switched the operation to any mode other than memory during measurement of rotation center error or workpiece installation error.		
<b>Remedy</b>		
Switch the operation to memory mode.		
Manual interruption, automatic operation handle interruption, MDI interruption, etc. are invalid during error measurement.		
Execute cycle start after completion or cancel of the measurement.		

<b>M01</b>	<b>Machining surface operation disabled</b>	0250
<b>Details</b>		
Machining surface operation (selection, indexing or cancel) was attempted while the operation is disabled.		
<b>Remedy</b>		
<ul style="list-style-type: none"> <li>• Cancel the other modes so that the inclined surface machining command (G68.2), tool axis direction control (G53.1) and the inclined surface machining cancel command (G69) can be issued.</li> <li>• Wait until the axes stop completely (until the smoothing for all axes reaches zero).</li> <li>• Perform operation search for machining programs.</li> </ul>		
<b>M01</b>	<b>Axs travel n/a in manual index</b>	0251
<b>Details</b>		
Moving a rotary axis was attempted during manual machining surface indexing, when a manual operation mode other than handle mode was selected.		
<b>Remedy</b>		
<ul style="list-style-type: none"> <li>• Change the operation mode to a handle mode before carrying out the manual surface indexing.</li> </ul>		
<b>M01</b>	<b>Tool length compensation amt 0</b>	0252
<b>Details</b>		
The tool length compensation amount for performing the R-Navi indexing type 2 is 0.		
<b>Remedy</b>		
<ul style="list-style-type: none"> <li>• Set the tool length compensation amount for performing the indexing type 2 to a value other than 0.</li> </ul>		
<b>M01</b>	<b>Feat coord ill w/ multi-handle</b>	0253
<b>Details</b>		
Manual feed feature coordinate system was selected while two or more handles were ON.		
<b>Remedy</b>		
<ul style="list-style-type: none"> <li>• Manual feed on a feature coordinate system is disabled while two or more handles are enabled (*).</li> <li>• Press [Manual coord] and select the machine coordinate system.</li> <li>• Reduce the number of enabled handles (*) to one.</li> <li>• (*) An enabled handle means the handle for which "Nth handle valid" signal (HSnS) is ON.</li> </ul>		
<b>M01</b>	<b>No spec: Spatial error comp</b>	0260
<b>Details</b>		
The spatial error compensation option is not available.		
<b>Remedy</b>		
Check the specifications.		
<b>M01</b>	<b>Spatial error comp excessive</b>	0261
<b>Details</b>		
The compensation amount is outside the setting range. Due to the calculation of the excessive amount, it is clamped by +/-1mm.		
<b>Remedy</b>		
Set the compensation amount within the setting range.		

<b>M01</b>	<b>Auto backlash adjust illegal</b>	0270
<b>Details</b>		
<ul style="list-style-type: none"> <li>♦A measurement condition adjustment or backlash adjustment was attempted to an axis with which automatic backlash adjustment is impossible.</li> <li>♦A measurement condition adjustment or backlash adjustment was attempted even though all the axes had not reached the 1st reference position.</li> <li>♦The operation mode is other than memory mode.</li> <li>♦The slave axis of synchronous control is selected as adjustment axis.</li> <li>♦An attempt has been made to start an adjustment by cycle start.</li> </ul>		
<b>Remedy</b>		
<ul style="list-style-type: none"> <li>♦Check the adjustment axis.</li> <li>♦Start the adjustment after all the axes return to the 1st reference position.</li> <li>♦Check the operation mode.</li> <li>♦Select the master axis of synchronous control as adjustment axis when adjusting the slave axis.</li> <li>♦Start the adjustment by automatic backlash adjustment start signal.</li> </ul>		
<b>M01</b>	<b>Operating auto backlash adjust</b>	0271
<b>Details</b>		
An illegal operation was attempted during measurement condition adjustment or backlash adjustment.		
<b>Remedy</b>		
<ul style="list-style-type: none"> <li>♦Continue the operation after canceling the measurement condition adjustment and backlash adjustment.</li> </ul>		
<b>M01</b>	<b>APLC password mismatch</b>	0280
<b>Details</b>		
The APLC authentication password is inconsistent.		
<b>Remedy</b>		
<ul style="list-style-type: none"> <li>♦Contact the machine tool builder.</li> </ul>		
<b>M01</b>	<b>High-cycle sampling disabled</b>	0290
<b>Details</b>		
<ul style="list-style-type: none"> <li>♦The drive unit's hardware or software does not conform to the high-cycle sampling mode.</li> <li>♦High-cycle data are not used even when high-cycle sampling has been set.</li> <li>♦High-cycle sampling was attempted while the axis targeted for high-cycle sampling was moving.</li> <li>♦High-cycle sampling was attempted during speed monitor mode.</li> <li>♦High-cycle sampling was attempted while any of the following operations is being executed: Dog-type zero point return, absolute position setting, synchronous tapping, spindle synchronization, hobbing, tool spindle synchronization IC.</li> </ul>		
<b>Remedy</b>		
<ul style="list-style-type: none"> <li>♦The software or hardware does not conform to the function. Contact service center.</li> <li>♦Set data for high-cycle sampling.</li> <li>♦Execute high-cycle sampling after stopping the axis targeted for high-cycle sampling.</li> <li>♦Execute high-cycle sampling after cancelling the speed monitor mode.</li> <li>♦Execute high-cycle sampling after stopping the currently executed functions.</li> </ul>		

<b>M01</b>	<b>N/A during high-cycle sampling</b>	0291
<b>Details</b>		
<ul style="list-style-type: none"> <li>•An attempt to activate "Speed monitor mode" was made during the high-cycle sampling mode.</li> <li>•An attempt to change the gear signal was made during the high-cycle sampling mode.</li> <li>•An attempt to execute spindle orientation was made during the high-cycle sampling mode.</li> <li>•Spindle detach was attempted during the high-cycle sampling mode.</li> <li>•Any of the following operations was attempted during the high-cycle sampling mode: Dog-type zero point return, absolute position setting, spindle/C axis changeover, synchronous tapping, spindle synchronization, hobbing, or tool spindle synchronization IC.</li> </ul>		
<b>Remedy</b>		
<ul style="list-style-type: none"> <li>•Change the speed monitor mode signal back, finish high-cycle sampling, and then select the speed monitor mode.</li> <li>•Change the gear signal back, finish high-cycle sampling, and then change the gear.</li> <li>•Change the spindle orientation signal back, finish high-cycle sampling, and then execute orientation.</li> <li>•Change the spindle detach signal back, finish high-cycle sampling, and then carry out spindle detachment.</li> <li>•Execute the operation after terminating high-cycle sampling.</li> </ul>		
<b>M01</b>	<b>Invalid cmd during param write</b>	0292 (Axis name)
<b>Details</b>		
A function which is unavailable during parameter write was commanded.		
<ul style="list-style-type: none"> <li>•Spindle/C axis changeover</li> <li>•Speed observation mode signal ON</li> <li>•High-speed synchronous tapping</li> <li>•PLC axis indexing</li> </ul>		
<b>Remedy</b>		
<ul style="list-style-type: none"> <li>•Cancel the write of the parameter.</li> <li>•Command the following functions after the parameter write is completed. <ul style="list-style-type: none"> <li>- Spindle/C axis changeover</li> <li>- Speed observation mode signal ON</li> <li>- High-speed synchronous tapping</li> <li>- PLC axis indexing</li> </ul> </li> </ul>		
<b>M01</b>	<b>SP orient. Z detection error</b>	0301
<b>Details</b>		
Z phase detection has failed to be completed during execution of proximity-switch orientation.		
<b>Remedy</b>		
<ul style="list-style-type: none"> <li>•Check for a failure of the proximity switch.</li> </ul>		
<b>M01</b>	<b>Illegal movement command during superimposition</b>	1003
<b>Details</b>		
<ul style="list-style-type: none"> <li>•A machine command was issued to the superimposed axis.</li> <li>•Reference position return was attempted on the superimposed axis.</li> <li>•Skip command was issued to the reference or superimposed axis.</li> <li>•Dog-type reference position return was attempted on the reference axis.</li> </ul>		
<b>Remedy</b>		
<ul style="list-style-type: none"> <li>•Correct the program.</li> </ul>		

<b>M01</b>	<b>Superimposition command illegal</b>	1004
<b>Details</b>		
<ul style="list-style-type: none"> <li>♦Superimposition start command was issued to the axis which was in any of the following states. <ul style="list-style-type: none"> <li>Synchronization control</li> <li>Milling interpolation</li> <li>Feed-forward thread cutting control</li> </ul> </li> <li>♦Superimposition start command was issued to the axis which was under superimposition control.</li> <li>♦Superimposition start command was issued to an axis that belongs to the same part system as a reference or synchronized axis of control axis synchronization between part systems.</li> </ul>		
<b>Remedy</b>		
<ul style="list-style-type: none"> <li>♦Correct the program.</li> <li>♦Turn OFF the feed-forward control request signal.</li> </ul>		
<b>M01</b>	<b>G114.n command illegal</b>	1005
<b>Details</b>		
<p>G114.n has been commanded during the execution of G114.n.  G51.2 has been commanded when G51.2 spindle-spindle polygon machining mode has been already entered at another part system.  Multiple spindle synchronization set command is illegal.</p>		
<b>Remedy</b>		
<ul style="list-style-type: none"> <li>♦Command G113 to cancel the operation.</li> <li>♦Turn ON the "spindle synchronization cancel" signal (Y18B8: SPSYC) to cancel the operation.</li> <li>♦Command G50.2 to cancel the operation.</li> <li>♦Turn ON the "spindle-spindle polygon cancel" signal (YCD1) to cancel the operation.</li> <li>♦Correct the program.</li> </ul>		
<b>M01</b>	<b>Spindle in-use by synchro tap</b>	1007
<b>Details</b>		
<p>The spindle is being used in synchronized tapping.</p>		
<b>Remedy</b>		
<ul style="list-style-type: none"> <li>♦Cancel the synchronized tapping.</li> </ul>		
<b>M01</b>	<b>GB spindle synchro signal OFF</b>	1014
<b>Details</b>		
<ul style="list-style-type: none"> <li>♦A forward run, reverse run, orientation, synchronous tapping, spindle synchronization, tool spindle synchronization I, tool spindle synchronization II or C-axis servo ON command was issued to the reference spindle while the guide bushing spindle synchronization signal was OFF.</li> <li>♦The guide bushing spindle synchronization signal was turned OFF during a forward run, reverse run, orientation, synchronous tapping, spindle synchronization, tool spindle synchronization I, tool spindle synchronization II or C-axis servo ON command.</li> <li>♦Orientation was commanded during the "guide bushing spindle synchronization" signal ON with spindle zero point detection with proximity switch and turret indexing enabled.</li> <li>♦C axis servo ON was commanded during the "guide bushing spindle synchronization" signal ON with spindle C axis parameter change enabled.</li> </ul>		
<b>Remedy</b>		
<ul style="list-style-type: none"> <li>♦Check the ladder program.</li> <li>♦Check the parameters.</li> </ul>		
<b>M01</b>	<b>GB SP sync:Spindle type error</b>	1015
<b>Details</b>		
<ul style="list-style-type: none"> <li>♦An analog spindle is used for the master spindle or the guide bushing spindle.</li> <li>♦Spindle-mode servo is used for the master spindle or the guide bushing spindle.</li> <li>♦Turret gear change control valid spindle is used for the master spindle or the guide bushing spindle.</li> </ul>		
<b>Remedy</b>		
<ul style="list-style-type: none"> <li>♦Check the parameters.</li> <li>♦Change the reference spindle or the guide bushing spindle to spindle drive unit.</li> <li>♦Change the reference spindle or the guide bushing spindle to turret gear change control invalid.</li> </ul>		

<b>M01</b>	<b>GB SP sync:Phase mem sgnl ilgl</b>	1021
<b>Details</b>		
<ul style="list-style-type: none"> <li>•The guide bushing spindle synchronization phase memory signal was turned ON while the master spindle or guide bushing spindle was rotating.</li> <li>•The guide bushing spindle synchronization phase memory signal was turned ON while the guide bushing spindle synchronization signal was OFF.</li> </ul>		
<b>Remedy</b>		
<ul style="list-style-type: none"> <li>•Check the ladder program.</li> </ul>		
<b>M01</b>	<b>GB SP sync:Phase set sgnl ilgl</b>	1022
<b>Details</b>		
<ul style="list-style-type: none"> <li>•The guide bushing spindle synchronization phase alignment signal was turned ON while the master spindle or guide bushing spindle was stopped.</li> </ul>		
<b>Remedy</b>		
<ul style="list-style-type: none"> <li>•Check the ladder program.</li> </ul>		
<b>M01</b>	<b>GB SP sync:Z phase not pass</b>	1023
<b>Details</b>		
<ul style="list-style-type: none"> <li>•When the guide bushing spindle synchronization phase memory signal was ON, the master spindle or guide bushing spindle's Z-phase was not passed.</li> </ul>		
<b>Remedy</b>		
<ul style="list-style-type: none"> <li>•Check the ladder program.</li> </ul>		
<b>M01</b>	<b>Cmnd impsbl in spindle rtry ax</b>	1024
<b>Details</b>		
<p>Toward the synchronous tapping spindle, the switch to servo-mode is commanded to the spindle-mode rotary axis.</p> <p>The spindle-mode rotary axis in servo-mode is commanded as the synchronous tapping spindle.</p>		
<b>Remedy</b>		
<p>Switch to the spindle-mode rotary axis.</p>		
<b>M01</b>	<b>Other cmnd disabled in orient.</b>	1025
<b>Details</b>		
<ul style="list-style-type: none"> <li>•Spindle superimposition control command has been given to an orientation mode spindle with the said spindle treated as either the reference or superimposed spindle.</li> <li>•Orientation command has been given to the reference or superimposed spindle that is under spindle superimposition control.</li> </ul>		
<b>Remedy</b>		
<ul style="list-style-type: none"> <li>•Cancel the orientation mode.</li> <li>•Use G113 or the "Spindle sync cancel" signal to cancel spindle superimposition.</li> </ul>		
<b>M01</b>	<b>SP-C ax ctrl runs independntly</b>	1026
<b>Details</b>		
<p>C axis mode command has been issued for polygon machining spindle.</p> <p>C axis mode command has been issued for synchronized tapping spindle.</p> <p>Polygon command has been issued for synchronized tapping spindle.</p> <p>Spindle is being used as spindle/C axis.</p>		
<b>Remedy</b>		
<ul style="list-style-type: none"> <li>•Cancel the C axis command.</li> <li>•Cancel the polygon machining command.</li> <li>•Cancel the C axis with servo OFF.</li> </ul>		

<b>M01</b>	<b>Thread recutting impossible</b>	1027
<b>Details</b>		
<ul style="list-style-type: none"> <li>♦The lead axis for thread recutting is not present in a thread recut enabled part system.</li> <li>♦A variable lead thread cut command has been given in the first thread cut block of thread recutting.</li> </ul>		
<b>Remedy</b>		
<ul style="list-style-type: none"> <li>♦Thread recutting is not supported. Disable thread recutting or press RESET to cancel the alarm, and correct the program.</li> </ul>		
<b>M01</b>	<b>Thread recutting data illegal</b>	1028
<b>Details</b>		
The lead axis and spindle for thread cutting are different from those predetermined.		
<b>Remedy</b>		
<ul style="list-style-type: none"> <li>♦Disable thread recutting or press RESET to cancel the alarm, and correct the settings of lead axis and spindle.</li> </ul>		
<b>M01</b>	<b>Variable speed thread disabled</b>	1029
<b>Details</b>		
<ul style="list-style-type: none"> <li>♦ "#8045 Varying spd thread" has been set to "1" to issue a variable speed thread cut command even though the function is not included in the specifications.</li> <li>♦A variable speed thread cut command has been given while the feed axis acceleration/deceleration type is soft acceleration/deceleration.</li> <li>♦A variable speed thread cut command has been given while the spindle encoder signal is not sent via serial input.</li> <li>♦A variable speed thread cut command has been given even though the spindle, lead axis or plane composing axes are controlled by drive other than MDS-E Series.</li> <li>♦The spindle intended for thread cutting is executing synchronous tapping, spindle synchronization, guide bushing spindle synchronization or spindle/C axis control.</li> </ul>		
<b>Remedy</b>		
<ul style="list-style-type: none"> <li>♦Check the specifications.</li> <li>♦Check the parameters.</li> <li>♦Check the program.</li> <li>♦Check the Encoder selection signal (R register).</li> </ul>		
<b>M01</b>	<b>Synchronization mismatch</b>	1030
<b>Details</b>		
Different M codes were each commanded as synchronization M code in each of the two part systems. Synchronization with the "!" code was commanded in another part system during M code synchronization. Synchronization with the M code was commanded in another part system during synchronization with the "!" code.		
<b>Remedy</b>		
<ul style="list-style-type: none"> <li>♦Correct the program so that the M codes match.</li> <li>♦Correct the program so that the same synchronization codes are commanded.</li> </ul>		
<b>M01</b>	<b>Multiple C axes select invalid</b>	1031
<b>Details</b>		
The "C axis selection" signal has been changed when the multiple C axes selection is not available. The selected axis by the "C axis selection" signal cannot be controlled for the multiple C axes selection.		
<b>Remedy</b>		
<ul style="list-style-type: none"> <li>♦Correct the parameter settings and program.</li> </ul>		
<b>M01</b>	<b>Tap retract Sp select illegal</b>	1032
<b>Details</b>		
Tap retract has been executed with a different spindle selected. Cutting feed is in wait state until synchronization is completed.		
<b>Remedy</b>		
<ul style="list-style-type: none"> <li>♦Select the spindle for which tap cycle was halted before turning ON the "tap retract" signal.</li> </ul>		



<b>M01</b>	<b>Sp-Sp polygon cut interlock</b>	1033
<b>Details</b>		
Cutting feed is in wait state until synchronization is completed.		
<b>Remedy</b>		
•Wait for the synchronization to end.		
<b>M01</b>	<b>Mixed sync ctrl prmtr illegal</b>	1034
<b>Details</b>		
There is a mistake in the settings of mixed control axis parameters (crsax [1] to [8]). Mixed control was attempted within one and the same part system. Any of the parameter settings is disabling mixed control.		
<b>Remedy</b>		
•Check the parameter settings for mixed synchronization control.		
<b>M01</b>	<b>Mixed sync ctrl disable modal</b>	1035
<b>Details</b>		
Mixed synchronization control was commanded for a part system in which mixed synchronization control is disabled as shown below.		
<ul style="list-style-type: none"> <li>•During nose R compensation mode</li> <li>•During pole coordinate interpolation mode</li> <li>•During cylindrical interpolation mode</li> <li>•During balance cut mode</li> <li>•During fixed cycle machining mode</li> <li>•During facing turret mirror image</li> <li>•During constant surface speed control mode</li> <li>•During hobbing mode</li> <li>•During axis name switch</li> <li>•During interference check III alarm (interference detection, interference alarm area intrusion or interference warning area intrusion)</li> </ul>		
An axis was transferred to another part system, and mixed control was attempted with the part system's maximum number of control axes exceeded.		
An axis was removed from the part system, and mixed control was attempted with the part system's number of axes zero.		
Another axis exchange was attempted to the axis which was already transferred to another part system for mixed control.		
Mixed control was attempted with an axis of a part system not in automatic operation.		
<b>Remedy</b>		
•Correct the program.		
<b>M01</b>	<b>Synchro ctrl setting disable</b>	1036
<b>Details</b>		
"Synchronous control operation method" was set (with R2589) when the mode was not the C axis mode. "Synchronous control operation method" was set (with R2589) in the zero point not set state. Mirror image is disabled. External mirror image or parameter mirror image was commanded during facing turret mirror image. You have set the "Synchronous control operation method" (R2589) of multiple axis synchronization, although the multiple axis synchronization control cannot be used.		
<b>Remedy</b>		
<ul style="list-style-type: none"> <li>•Set the contents of the R2589 register to "0".</li> <li>•Correct the program and parameters.</li> </ul>		
<b>M01</b>	<b>Synchro start/cancel disable</b>	1037
<b>Details</b>		
Synchronous control start/cancel command was issued when the start/cancel is disabled.		
<b>Remedy</b>		
•Correct the program and parameters.		

## 1 Operation Errors (M)

<b>M01</b>	<b>Move cmnd invld to synchro ax</b>	1038
	<b>Details</b>	
	A travel command was issued to a synchronized axis in synchronous control.	
	<b>Remedy</b>	
	♦Correct the program.	
<b>M01</b>	<b>No spindle speed clamp</b>	1043
	<b>Details</b>	
	♦When "#1146 Sclamp" has been set to "1", the constant surface speed command (G96) was issued to the spindle which is not selected for the spindle speed clamp command (G92/G50) under Multiple spindle control II.	
	♦When "#1146 Sclamp" has been set to "0", both the G96 (Constant surface speed control ON) modal and the spindle forward or reverse rotation signal have turned ON for the spindle, on which the speed clamp command is disabled.	
	<b>Remedy</b>	
	Press the reset key and carry out the remedy below.	
	♦Issue the G92/G50 command to the spindle that is to be used for the constant surface speed control.	
<b>M01</b>	<b>Cont ax superimpos II prm illg</b>	1044
	<b>Details</b>	
	♦ There is a mistake in the setting of the superimposition control reference axis parameter (#2089 bsax_pl).	
	♦ Superimposition control is not available under the current parameter settings.	
	<b>Remedy</b>	
	♦Correct the parameter.	
<b>M01</b>	<b>Sync error btwn part systems</b>	1045
	<b>Details</b>	
	After a single block stop or automatic operation pause was executed during single block between part systems, cycle start has not been performed on either part system.	
	<b>Remedy</b>	
	Perform cycle start for all the part systems where a single block stop or automatic operation pause was executed.	
<b>M01</b>	<b>Z detect speed parameter error</b>	1049
	<b>Details</b>	
	Phase-Z detection speed has not been set in "#3109 zdetspd".	
	<b>Remedy</b>	
	♦Set the phase-Z detection speed in "#3109 zdetspd".	
<b>M01</b>	<b>Intrf chck across sys: Set err</b>	1050
	<b>Details</b>	
	Setting of Interference check across part systems is incorrect.	
	<b>Remedy</b>	
	♦Correct the setting of Interference check across part systems.	
<b>M01</b>	<b>Intrf chck across sys: Area AL</b>	1051
	<b>Details</b>	
	Interference is already occurring on the set interfering object.	
	<b>Remedy</b>	
	♦Turn OFF the interference check valid signal, moving the axis to a position where the interfering objects do not collide each other, and then restart Interference check across part systems.	

<b>M01</b>	<b>Intrf check across sys: Alarm</b>	1052
	<b>Details</b>	
	A command has been given that causes the interfering objects to collide each other.	
	<b>Remedy</b>	
	•Correct the program.	
<b>M01</b>	<b>Interfe chk Opt return incomp</b>	1053
	<b>Details</b>	
	Interference check between part systems had started while zero point return of the part system set interfering object has not completed.	
	<b>Remedy</b>	
	•Turn OFF the interference check valid signal, and complete zero point return in the all part systems set interfering object.	
<b>M01</b>	<b>Coil switch duration excess</b>	1057
	<b>Details</b>	
	Coil switch operation was not completed within the following time: SP114 (#13114) × MKT_Rate (#11760)/100.	
	<b>Remedy</b>	
	•Check and, if necessary, modify the following parameters: "#13114 SP114" (Coil changeover gate cutoff timer) and "#11760 MKT_Rate" (Threshold percentage for monitoring coil switch duration).	
	•Check for a welded contactor.	
	This alarm can be cancelled after execution of emergency stop.	
<b>M01</b>	<b>Feed-forward control disabled</b>	1060
	<b>Details</b>	
	Feed-forward control was attempted while any of the following functions was enabled.	
	•Control axis superimposition I/II	
	•Control axis synchronization between part systems I/II	
	<b>Remedy</b>	
	•Turn OFF the feed-forward control request signal.	
<b>M01</b>	<b>Superimposition axis param err</b>	1070
	<b>Details</b>	
	•Cutting feed clamp rate is unspecified for a superimposition-related axis. Or the specified rate is outside the setting range. "#2091 plclamp", "#2629 pl3clamp" or "#2630 pl3clamp2"	
	•Rapid traverse rate is unspecified for a superimposition-related axis. Or the specified rate is outside the setting range. "#2090 plrapid", "#2621 plrapid2", "#2626 pl3rapid", "#2627 pl3rapid2" or "#2628 pl3rapid3"	
	<b>Remedy</b>	
	•Set the cutting feed clamp rate of the superimposition-related axis within the setting range.	
	•Set the rapid traverse rate of the superimposition-related axis within the setting range.	

<b>M01</b>	<b>Tool retract &amp; return disabled</b>	1080
<b>Details</b>		
Tool retract and return command has been given in any of the following modes:		
<ul style="list-style-type: none"> <li>♦ Mixed control (Cross axis control) I</li> <li>♦ Mixed control (Cross axis control) II</li> <li>♦ Control axis synchronization between part systems I</li> <li>♦ Control axis synchronization between part systems II</li> <li>♦ Control axis superimposition I</li> <li>♦ Control axis superimposition II</li> <li>♦ Arbitrary axis superimposition control</li> <li>♦ Tool spindle synchronization IA (spindle - spindle polygon)</li> <li>♦ Tool spindle synchronization IB (spindle - spindle polygon)</li> <li>♦ Tool spindle synchronization IC (spindle - NC axis polygon)</li> <li>♦ Tool spindle synchronization II (hob)</li> <li>♦ Spindle superimposition control</li> </ul>		
<b>Remedy</b>		
Turn OFF the transit point designation signal.		
<b>M01</b>	<b>Arbitrary axis unexchangeable</b>	1101
<b>Details</b>		
The axis declared in the arbitrary axis exchange command is incapable of being exchanged.		
<b>Remedy</b>		
<ul style="list-style-type: none"> <li>♦Correct the program (mainly check the processing timing).</li> </ul>		
<b>M01</b>	<b>Cross control axis exists</b>	1102
<b>Details</b>		
A manual travel command has been given to the axis being exchanged when manual interruption is disabled under cross machining control (when "#1435 crsman" = 0).		
<b>Remedy</b>		
<ul style="list-style-type: none"> <li>♦This error can be cancelled by either one of the following operations.</li> </ul> <ol style="list-style-type: none"> <li>1: Cancel the manual travel command</li> <li>2: Reset the NC</li> </ol>		
<b>M01</b>	<b>Arbitrary ax superimp. sys err</b>	1103
<b>Details</b>		
<ul style="list-style-type: none"> <li>♦Arbitrary axis superimposition command has been issued in any part system other than the one that contains either the reference or superimposed axis of arbitrary axis superimposition control.</li> <li>♦Arbitrary axis superimposition cancel command has been issued in any part system other than the one that contains the superimposed axis of arbitrary axis superimposition control.</li> </ul>		
<b>Remedy</b>		
<ul style="list-style-type: none"> <li>♦Correct the program so that the arbitrary axis superimposition command is given in an appropriate part system.</li> </ul>		
<b>M01</b>	<b>Spindle speed fluctuation</b>	1105
<b>Details</b>		
The actual spindle speed has fluctuated exceeding the allowable range, while spindle speed fluctuation detection (G162) is active.		
The number following "S", which is output together with this alarm, indicates the spindle where speed fluctuations were detected.		
<b>Remedy</b>		
<ul style="list-style-type: none"> <li>♦Unnecessarily large load may be applied to the spindle during automatic operation. Reduce the spindle load.</li> <li>♦To prevent this alarm from being output during spindle speed fluctuation detection (G162), set the parameter #1242 set14 BIT2 to ON.</li> </ul>		

<b>M01</b>	<b>Sp synchro phase calc illegal</b>	1106
	<b>Details</b>	
	Spindle synchronization phase alignment command was issued while the "phase shift calculation request" signal was ON.	
	<b>Remedy</b>	
	<ul style="list-style-type: none"> <li>•Correct the program.</li> <li>•Correct the sequence program.</li> </ul>	
<b>M01</b>	<b>Illegal cmd in SP oscillation</b>	1108
	<b>Details</b>	
	A function that cannot be used with spindle oscillation was commanded during spindle oscillation.	
	<b>Remedy</b>	
	<ul style="list-style-type: none"> <li>•Command the function after finishing spindle oscillation.</li> </ul>	
<b>M01</b>	<b>SP oscillation cmd illegal</b>	1109
	<b>Details</b>	
	Spindle oscillation was commanded during executing a function that cannot be used with spindle oscillation.	
	<b>Remedy</b>	
	<ul style="list-style-type: none"> <li>•Command spindle oscillation after finishing the function that cannot be used with spindle oscillation.</li> </ul>	
<b>M01</b>	<b>SP oscillation set val illegal</b>	1110
	<b>Details</b>	
	Spindle oscillation was commanded while a value out of range is set as spindle oscillation amplitude or spindle oscillation frequency.	
	<b>Remedy</b>	
	<ul style="list-style-type: none"> <li>•Check the setting values of the amplitude and frequency.</li> </ul>	
<b>M01</b>	<b>Sub part system I call error</b>	1111
	<b>Details</b>	
	<ul style="list-style-type: none"> <li>•Sub part system control I command (G122) has been given to a part system where the sub part system I operation mode is deactivated.</li> <li>•Sub part system control I command (G122) has been given to a part system which is not reserved as the sub part system in M80.</li> </ul>	
	<b>Remedy</b>	
	<ul style="list-style-type: none"> <li>•Activate the sub part system I operation mode for the sub part system before issuing G122.</li> </ul> Part systems marked "SUB" on the monitor screen are under the sub part system I operation mode. <ul style="list-style-type: none"> <li>•Command the sub part system start to the sub part system which is reserved with "#1483 SBS1_sys num" for M80.</li> </ul>	
<b>M01</b>	<b>Sub part system II start error</b>	1112
	<b>Details</b>	
	When the sub part system control II has been commanded, no part system is left capable of being activated as a sub part system.	
	<b>Remedy</b>	
	<ul style="list-style-type: none"> <li>•Do not exceed the maximum number of simultaneously activatable sub part systems when commanding G144.</li> <li>•Set the parameter #1437 SBS2_Spec BIT0 to 0 if you wish to wait until the sub part system becomes capable of being activated.</li> </ul>	
<b>M01</b>	<b>Constant surface speed rndnt</b>	1113
	<b>Details</b>	
	<ul style="list-style-type: none"> <li>•Constant surface speed is commanded from other part system to the spindle that is in the thread/ thread cycle or the tapping cycle/ synchronous tapping cycle.</li> <li>•To the spindle in constant surface speed control, the thread/ thread cycle or the tapping cycle/ synchronous tapping cycle are commanded from other part system.</li> </ul>	
	<b>Remedy</b>	
	<ul style="list-style-type: none"> <li>•Check the program.</li> </ul>	

<b>M01</b>	<b>Constant torque disabled</b>	1114
<b>Details</b>		
<ul style="list-style-type: none"> <li>•Constant torque control is commanded to the axis which the parameter "#2296 SV096(TQC)" (Constant torque control: Stopper-direction torque) setting is "0".</li> <li>•Constant or proportional torque stopper control is commanded to the axis which is in movement by automatic or manual operation.</li> <li>•Constant torque control is canceled to the constant torque control axis in movement by automatic or manual operation.</li> <li>•Constant torque control is commanded to the proportional torque stopper control axis.</li> <li>•Constant torque control is commanded again during the axis movement by constant torque control cancel.</li> <li>•Constant torque control axis is at stroke limit or H/W stroke end.</li> </ul>		
<b>Remedy</b>		
<ul style="list-style-type: none"> <li>•Check the program.</li> <li>•Check the sequence program.</li> </ul>		
<b>M01</b>	<b>P torque stopper disabled</b>	1115
<b>Details</b>		
<ul style="list-style-type: none"> <li>•Proportional torque stopper control is commanded to the axis which the parameter "#2296 SV096(TQC)" (Constant torque control: Stopper-direction torque) setting is "0".</li> <li>•Proportional torque stopper control is commanded to the axis which is in movement by automatic or manual operation.</li> <li>•The axis movement is commanded to the axis which is in the proportional torque constant control.</li> <li>•Proportional torque constant control is commanded again during the axis movement by proportional torque constant control cancel.</li> <li>•Proportional torque constant control axis is at stroke limit or H/W stroke end.</li> </ul>		
<b>Remedy</b>		
<ul style="list-style-type: none"> <li>•Check the program.</li> <li>•Check the sequence program.</li> </ul>		
<b>M01</b>	<b>Droop cancel disabled</b>	1116
<b>Details</b>		
<ul style="list-style-type: none"> <li>•Constant torque control droop cancel is commanded to the axis which is not in the constant/ proportional torque control.</li> <li>•Constant torque control droop cancel is commanded to the axis in movement by automatic or manual operation.</li> </ul>		
<b>Remedy</b>		
<ul style="list-style-type: none"> <li>•Check the program.</li> <li>•Check the sequence program.</li> </ul>		
<b>M01</b>	<b>Cmnd disabled in droop cancel</b>	1117
<b>Details</b>		
The axis movement by automatic or manual operation is commanded to the axis which the constant torque control droop is being canceled.		
<b>Remedy</b>		
<ul style="list-style-type: none"> <li>•Check the program.</li> <li>•Check the sequence program.</li> </ul>		
<b>M01</b>	<b>SP equivalent load factor over</b>	1120
<b>Details</b>		
The equivalent load factor of the spindle motor has exceeded the set threshold that causes the excess warning.		
<b>Remedy</b>		
<ul style="list-style-type: none"> <li>•Change the operation pattern in a way that decreases the spindle motor load.</li> </ul>		

<b>M01</b>	<b>Differential tap cmd disabled</b>	1131
<b>Details</b>		
<ul style="list-style-type: none"> <li>•Differential speed tap command has been given although any rotation command has not been input to the reference spindle that is under spindle superimposition control.</li> <li>•Synchronous tap command has been given to the reference spindle that is under spindle superimposition control.</li> </ul>		
<b>Remedy</b>		
<ul style="list-style-type: none"> <li>•Cancel the synchronous tapping cycle.</li> </ul>		
<b>M01</b>	<b>Spd clamp in differential tap</b>	1132
<b>Details</b>		
<ul style="list-style-type: none"> <li>•A tap cycle or synchronous tap cycle command given to the superimposed spindle has caused the spindle's actual rotation speed to exceed the spindle clamp speed.</li> </ul>		
<b>Remedy</b>		
<ul style="list-style-type: none"> <li>•Correct the spindle rotation speed in synchronous tap cycle.</li> </ul>		
<b>M01</b>	<b>Constant surface spd disabled</b>	1133
<b>Details</b>		
<ul style="list-style-type: none"> <li>•A constant surface speed control command has been given to the reference or superimposed spindle during differential speed tapping under spindle superimposition control.</li> <li>•A differential speed tapping command has been issued while constant surface speed control is executed on the reference or superimposed spindle that is under spindle superimposition control.</li> </ul>		
<b>Remedy</b>		
<ul style="list-style-type: none"> <li>•Cancel the synchronous tap cycle or constant surface speed control.</li> </ul>		
<b>M01</b>	<b>Spindle sync cancel error</b>	1135
<b>Details</b>		
<ul style="list-style-type: none"> <li>•Spindle synchronization cancel command has been issued during rotation of C axis under spindle sync C axis control.</li> <li>•G113 (without the address H or D) has been issued during the spindle synchronization for two or more sync sets.</li> </ul>		
<b>Remedy</b>		
<ul style="list-style-type: none"> <li>•This operation error is cancelled when C axis stops. Issue a spindle sync cancel command after C axis has stopped.</li> <li>•Use G113D or G113H to cancel the spindle synchronization.</li> </ul>		
<b>M01</b>	<b>GB SP sync:Cancel sgnl illegal</b>	1137
<b>Details</b>		
<p>The guide bushing spindle synchronization temporary cancel signal was turned ON/OFF when the master spindle and the guide bushing spindle were in one of the following modes.</p> <ul style="list-style-type: none"> <li>•During rotation (when not stopped)</li> <li>•During tap cycle synchronization mode</li> <li>•During spindle synchronization mode</li> <li>•During tool-spindle synchronization I (polygon machining) mode</li> <li>•During tool-spindle synchronization II (hobbing) mode</li> <li>•During spindle C axis control C axis mode</li> <li>•During orientation/indexing</li> </ul>		
<b>Remedy</b>		
<ul style="list-style-type: none"> <li>•Check the ladder program.</li> </ul>		
<b>M01</b>	<b>GB SP sync runs independently</b>	1138
<b>Details</b>		
<ul style="list-style-type: none"> <li>•The reference spindle was commanded as a spindle related to tool spindle synchronization IC (polygon).</li> <li>•The guide bushing spindle was commanded as a synchronous tapping spindle.</li> <li>•The guide bushing spindle was commanded as a spindle related to spindle synchronization/tool spindle synchronization I (polygon)/tool spindle synchronization II (hobbing).</li> </ul>		
<b>Remedy</b>		
<ul style="list-style-type: none"> <li>•Check the program.</li> </ul>		

## 1 Operation Errors (M)

<b>M01</b>	<b>Cmnds illegal in spindle synchr</b>	1139
	<b>Details</b>	
	Synchronous tapping was issued for the reference spindle or the synchronized spindle during spindle synchronization.	
	<b>Remedy</b>	
	•Cancel the synchronous tapping cycle by reset.	
<b>M01</b>	<b>Operation non-continuable(STO)</b>	1151
	<b>Details</b>	
	An axis in STO state exists in the part system.	
	<b>Remedy</b>	
	•Release the STO state and reset the NC.	
<b>M01</b>	<b>Operation non-continuable(SOS)</b>	1152
	<b>Details</b>	
	An axis in SOS state exists in the part system.	
	<b>Remedy</b>	
	•Release the SOS state and reset the NC.	
<b>M01</b>	<b>Prog check: work posn error</b>	1215
	<b>Details</b>	
	When the NC reset signal is input with the High-speed simple program check: Coordinate position check ON signal (Y76B) set to ON, the workpiece coordinate position is different from the position at the program start.	
	<b>Remedy</b>	
	•Correct the machining program.	
<b>M01</b>	<b>Prog check: machine posn error</b>	1216
	<b>Details</b>	
	When the NC reset signal is input with the High-speed simple program check: Coordinate position check ON signal (Y76B) set to ON, the machine coordinate position is different from the position at the program start.	
	<b>Remedy</b>	
	•Correct the machining program.	
<b>M01</b>	<b>NC/PLC axis switch illegal</b>	1250
	<b>Details</b>	
	The following operation was performed to an axis which can be switched over between NC axis and PLC axis.	
	•PLC axis switchover signal was turned ON or OFF when it was prohibited to switch over the axis.	
	<b>Remedy</b>	
	•Make sure the axis switchover status signal is OFF and change the ON/OFF of the axis switchover signal.	
<b>M01</b>	<b>No spec: Multi axis synch ctrl</b>	1254
	<b>Details</b>	
	You have set the R register for selecting synchronous control operation method, although the option of multiple axis synchronization control is OFF.	
	<b>Remedy</b>	
	•Set 0 in R2589 (Synchronous control operation method selection).	
<b>M01</b>	<b>Multiple secondary ax selected</b>	1255
	<b>Details</b>	
	For the multiple axis synchronization control, you selected two or more slave axes without selecting any master axis.	
	<b>Remedy</b>	
	•Correct the setting of R2589 (Synchronous control operation method selection).	



<b>M03</b>	<b>Interference detection</b>	0001	yyzz
<b>Details</b>			
A command has been given that causes two or more objects to interfere with each other.			
yy : Interference object definition number (1)			
zz : Interference object definition number (2)			
<b>Remedy</b>			
<ul style="list-style-type: none"> <li>•Cancel the alarm with reset.</li> <li>•Disable the interference check III mode first before moving the interfering object further in the interference direction.</li> </ul>			
<b>M03</b>	<b>Entry in interfere alarm area</b>	0002	yyzz
<b>Details</b>			
Two or more interfering objects are in the interference alarm area.			
yy : Interference object definition number (1)			
zz : Interference object definition number (2)			
<b>Remedy</b>			
<ul style="list-style-type: none"> <li>•Disable the interference check III mode before moving.</li> <li>•Check the interference definition and the interference selection.</li> </ul>			
<b>M03</b>	<b>Entry in interfere warn area</b>	0003	yyzz
<b>Details</b>			
A command has been given that causes two or more interfering objects to enter the interference warning area.			
yy : Interference object definition number (1)			
zz : Interference object definition number (2)			
<b>Remedy</b>			
<ul style="list-style-type: none"> <li>•Interfering objects are in the interference warning area.</li> </ul> <p>If an operational problem is expected to occur, stop moving the axes with feed hold, cancellation of manual axis movement or reset.</p>			
<b>M03</b>	<b>Interference data unspecified</b>	1001	
<b>Details</b>			
You attempted to turn ON the interference check III mode with the interfering object data disabled.			
<b>Remedy</b>			
<ul style="list-style-type: none"> <li>•Execute the interference data ON command to enable the interference data before turning ON the interference check III mode.</li> </ul>			
<b>M03</b>	<b>Interf. 3D objects count error</b>	1002	
<b>Details</b>			
The total number of solid objects used as interfering object has exceeded the maximum.			
<b>Remedy</b>			
<ul style="list-style-type: none"> <li>•The total number of interfering solid objects set in the system variable or R register has exceeded the maximum. Correct the setting.</li> </ul>			
<b>M03</b>	<b>Interfere check III: time over</b>	1003	
<b>Details</b>			
The allowable process time for interference check III has been exceeded.			
<b>Remedy</b>			
<ul style="list-style-type: none"> <li>•Turn OFF the interference check III mode.</li> <li>•Correct the interfering object definition.</li> </ul>			

<b>M03</b>	<b>Interfere: control axis error</b>	2001	Interference object definition number
<b>Details</b>			
In the interfering object definition, the IJK control axes have been set as follows:			
<ul style="list-style-type: none"> <li>♦Nonexistent axis name (an axis not set in the base axis specification parameter "#1022 axname2")</li> <li>♦I, J and K axes belong to different part systems</li> <li>♦Rotary axis</li> </ul>			
<b>Remedy</b>			
♦Correct the setting of the IJK control axes in the interfering object definition.			
<b>M03</b>	<b>Interf:2 rot axes in cylinder</b>	2002	Interference object definition number
<b>Details</b>			
In the interfering object definition, two or more rotary axes have been set for the cylindrical solid definition No.			
<b>Remedy</b>			
♦Correct the solid designation and the setting of the IJK axis rotation angle in the interfering object definition.			
<b>M03</b>	<b>Interfere:2 rot axes in cuboid</b>	2003	Interference object definition number
<b>Details</b>			
In the interfering object definition, two or more rotary axes have been set for the cuboidal solid definition No.			
<b>Remedy</b>			
♦Correct the setting of the IJK axis rotation angle in the interfering object definition.			
<b>M03</b>	<b>Interfere: rotary axis error</b>	2004	Interference object definition number
<b>Details</b>			
In the interfering object definition, the IJK rotary axes have been set as follows:			
<ul style="list-style-type: none"> <li>♦Nonexistent axis name (an axis not set in the base axis specification parameter (#1022 axname2))</li> <li>♦Linear axis</li> <li>♦All three axes are rotary axes</li> </ul>			
<b>Remedy</b>			
♦Correct the setting of the IJK rotary axes in the interfering object definition.			
<b>M03</b>	<b>Interfere:2 rot axes object er</b>	2005	Interference object definition number
<b>Details</b>			
The solid object set in the interfering object definition is unavailable as an interfering object defined with two rotary axes.			
<b>Remedy</b>			
♦Correct the setting of the solid in the interfering object definition.			
<b>M03</b>	<b>Interfere:1 rot axis object er</b>	2006	Interference object definition number
<b>Details</b>			
The solid object set in the interfering object definition is unavailable as an interfering object defined with one rotary axis.			
<b>Remedy</b>			
♦Correct the setting of the solid in the interfering object definition.			

<b>M03</b>	<b>Interf. selection: offset over</b>	3001	Interference object definition number
<b>Details</b>			
In the interfering object selection, the interfering object model coordinate system offset 1 has exceeded the setting.			
<b>Remedy</b>			
•Correct the setting of the interfering object model coordinate system offset 1 in the interfering object selection.			
<b>M03</b>	<b>Interf:rot objects comb. error</b>	3002	Interference object definition number
<b>Details</b>			
The following selection was made for the rotary interfering objects:			
•You selected a one-rotary-axis object and two-rotary-axis object at a time.			
•You selected two or more two-rotary-axis objects.			
<b>Remedy</b>			
•Correct the setting of the n-th interfering object selection.			
<b>M50</b>	<b>Workpiece offset unreflected</b>		5000
<b>Details</b>			
Any of the following offsets of the selected modal has not been reflected in the workpiece position counter: workpiece offset, extended workpiece offset, external workpiece offset or workpiece shift.			
<b>Remedy</b>			
The warning is cancelled by any of the following operations.			
•Cycle start			
•Reset			
•Emergency stop			
<b>M90</b>	<b>Parameter set mode</b>		
<b>Details</b>			
The setup parameter lock is released.			
Cycle start is disabled when setup parameters can be set.			
<b>Remedy</b>			
•Refer to the manual issued by the machine tool builder.			
<b>M97</b>	<b>Maintenance part activated</b>		
<b>Details</b>			
Activated maintenance part has not completed the product procedures.			
<b>Remedy</b>			
•Contact our service center.			

## **Stop Codes (T)**

<b>T01</b>	<b>Axis in motion</b>	0101
	<b>Details</b>	
	Automatic start is not possible as one of the axes is moving.	
	<b>Remedy</b>	
	•Try automatic start again after all axes have stopped.	
<b>T01</b>	<b>NC not ready</b>	0102
	<b>Details</b>	
	Automatic start is not possible as the NC is not ready.	
	<b>Remedy</b>	
	•Another alarm has occurred. Check the details and remedy.	
<b>T01</b>	<b>Reset signal ON</b>	0103
	<b>Details</b>	
	Automatic start is not possible as the "reset" signal has been input.	
	<b>Remedy</b>	
	•Turn OFF the "reset" signal.	
	•Check for any failure of the reset switch which has caused the switch's continuous ON.	
	•Correct the sequence program.	
<b>T01</b>	<b>Auto operation pause signal ON</b>	0104
	<b>Details</b>	
	The feed hold switch on the machine operation panel is ON (valid).	
	<b>Remedy</b>	
	•Correct the feed hold switch setting.	
	•The feed hold switch is B contact switch.	
	•Fix any broken wires in the feed hold signal line.	
	•Correct the sequence program.	
<b>T01</b>	<b>H/W stroke end axis exists</b>	0105
	<b>Details</b>	
	Automatic start is not possible as one of the axes is at the stroke end.	
	<b>Remedy</b>	
	•Manually move any axis whose end is at the stroke end.	
	•Check for any broken wires in the stroke end signal line.	
	•Check for any failure in the stroke end limit switch.	
<b>T01</b>	<b>S/W stroke end axis exists</b>	0106
	<b>Details</b>	
	Automatic start is not possible as one of the axes is at the stored stroke limit.	
	<b>Remedy</b>	
	•Move the axis manually.	
	•If the axis's end is not at the stroke end, check the parameters.	
<b>T01</b>	<b>No operation mode</b>	0107
	<b>Details</b>	
	The operation mode has not been selected.	
	<b>Remedy</b>	
	•Select automatic operation mode.	
	•Check for any broken wires in the signal line for automatic operation mode (memory, tape, MDI).	

## 2 Stop Codes (T)

<b>T01</b>	<b>Operation mode duplicated</b>	0108
	<b>Details</b>	
		Two or more automatic operation modes have been selected.
	<b>Remedy</b>	
		<ul style="list-style-type: none"> <li>♦Check for any short circuit in the mode (memory, tape, MDI) selection signal line.</li> <li>♦Check for any failure in the switch.</li> <li>♦Correct the sequence program.</li> </ul>
<b>T01</b>	<b>Operation mode changed</b>	0109
	<b>Details</b>	
		The automatic operation mode has changed to another automatic operation mode.
	<b>Remedy</b>	
		♦Return to the original automatic operation mode, and execute automatic start.
<b>T01</b>	<b>Tape search execution</b>	0110
	<b>Details</b>	
		Automatic start is not possible as tape search is being executed.
	<b>Remedy</b>	
		♦Wait for the tape search to be completed and then execute the automatic start.
<b>T01</b>	<b>Cycle start prohibit</b>	0111
	<b>Details</b>	
		Automatic start is disabled because restart search is in execution.
	<b>Remedy</b>	
		♦Execute automatic start after the restart search is completed.
<b>T01</b>	<b>CNC overheat</b>	0113
	<b>Details</b>	
		Automatic start is not possible because a thermal alarm (Z53 CNC overheat) has occurred.
	<b>Remedy</b>	
		<ul style="list-style-type: none"> <li>♦Temperature of the control unit has exceeded the specified temperature.</li> <li>♦Take appropriate measures to cool the unit.</li> </ul>
<b>T01</b>	<b>Cycle st. prohibit(Host comm.)</b>	0115
	<b>Details</b>	
		Automatic start cannot is not possible because the NC is communicating with the host computer.
	<b>Remedy</b>	
		♦Wait for the communication with host computer to be ended and then execute the automatic start.
<b>T01</b>	<b>Cycle st prohibit(Battery alm)</b>	0116
	<b>Details</b>	
		Automatic start is not possible because the voltage of the battery in the NC control unit has dropped.
	<b>Remedy</b>	
		<ul style="list-style-type: none"> <li>♦Replace the battery of the NC control unit.</li> <li>♦Contact the service center.</li> </ul>
<b>T01</b>	<b>R-pnt offset value not set</b>	0117
	<b>Details</b>	
		Automatic operation is not possible because no reference position offset value has been set.
	<b>Remedy</b>	
		♦Perform the reference position initialization setting, then set "#2034 rfpofs(Distance-coded reference position detection offset)".

## 2 Stop Codes (T)

<b>T01</b>	<b>In absolute position alarm</b>	0138
	<b>Details</b>	
	♦A start signal was input during an absolute position detection alarm.	
	<b>Remedy</b>	
	♦Clear the absolute position detection alarm, and then input the start signal.	
<b>T01</b>	<b>In abs posn initial setting</b>	0139
	<b>Details</b>	
	♦A start signal was input during zero point initialization in the absolute position detection system.	
	<b>Remedy</b>	
	♦Complete zero point initialization before inputting the start signal.	
<b>T01</b>	<b>In manual measurement</b>	0143
	<b>Details</b>	
	Automatic start is disabled because manual measurement is in execution.	
	<b>Remedy</b>	
	♦Execute automatic start after the manual measurement is completed.	
<b>T01</b>	<b>Sub part sys I mode is active</b>	0146
	<b>Details</b>	
	Cycle start signal was input for the part system that has applied Sub-part system I operation mode.	
	<b>Remedy</b>	
	♦Use Sub-part system I operation mode signal to switch whether to start the operation as Sub-part system control or to execute cycle start as Main-part system.	
<b>T01</b>	<b>Mach. interrupt non-startable</b>	0147
	<b>Details</b>	
	Machining interruption related functions cannot be started up.	
	<b>Remedy</b>	
	♦To resume the operation from the state of being stopped at the selected point, set the automatic operation mode to the memory mode.	
	♦To perform the retraction, confirm that retraction is enabled (the "Retraction executable" signal is ON).	
	♦To resume the operation from the state of being stopped at a certain block of the retraction program, activate the memory mode and turn ON the "Retraction start" signal.	
	♦Check the sequence program to make sure that multiple start signals are not input at the same time.	
	(Note) The remedies stated above apply not only to retraction but also to the other machining interruption-related functions. (The start signals and ready states are replaced with those for each function.)	
<b>T01</b>	<b>APLC password mismatch</b>	0160
	<b>Details</b>	
	Automatic start is disabled because the APLC authentication password is inconsistent.	
	<b>Remedy</b>	
	♦Contact the machine tool builder.	
<b>T01</b>	<b>Cycle st. prohibit(safe speed)</b>	0165
	<b>Details</b>	
	An automatic operation was started in one of the following machining modes during the safe speed clamp: thread cutting, synchronous tapping, cross machining, superimposition control, tool center point control or SSS control.	
	<b>Remedy</b>	
	♦Turn ON the safely-limited speed monitoring request signal and press the cycle start button.	
	♦Close the door and press the cycle start button.	

<b>T01</b>	<b>Cycle start prohibit (AL Z83)</b>	0172
	<b>Details</b>	
		Cycle start is disabled while the system alarm Z83 (NC started during SP rotation) is occurring.
	<b>Remedy</b>	
		♦Turn OFF the power and make sure that the spindle is at a standstill. And then turn the power ON again.
<b>T01</b>	<b>In interference check alarm</b>	0173
	<b>Details</b>	
		Cycle start cannot be operated because interference check alarm is in progress.
	<b>Remedy</b>	
		♦Release the interference check alarm before operating the cycle start.
<b>T01</b>	<b>Cycle st forbid (measuring err)</b>	0176
	<b>Details</b>	
		Cycle start cannot be executed for other part systems during measurement of rotation center error or workpiece installation error.
	<b>Remedy</b>	
		Execute cycle start for one part system that is ready for measurement.
		Cancel measurement when error measurement is not executed.
<b>T01</b>	<b>Cycle start prohibit (OP error)</b>	0177
	<b>Details</b>	
		Cycle start was executed during operation error where cycle start cannot be executed.
	<b>Remedy</b>	
		After canceling operation error, execute cycle start.
<b>T01</b>	<b>Cycle start prohibit(SBT warn)</b>	0185
	<b>Details</b>	
		Cycle start is disabled because the axis in SBT warning exists in the system.
	<b>Remedy</b>	
		After cancelling the SBT warning, execute the cycle start.
<b>T01</b>	<b>Cycle start prohibit</b>	0190
	<b>Details</b>	
		Automatic start is not possible because the setting of setup parameters is enabled.
	<b>Remedy</b>	
		♦Refer to the manual issued by the machine tool builder.
<b>T01</b>	<b>Cycle start prohibit</b>	0191
	<b>Details</b>	
		Automatic start was attempted while a file was being deleted/written.
	<b>Remedy</b>	
		♦Wait for the file to be deleted/written and then execute the automatic start.
<b>T01</b>	<b>Cycle st. prohibit (Term exp'd)</b>	0193
	<b>Details</b>	
		Automatic start is not possible because the valid term has been expired.
	<b>Remedy</b>	
		♦Obtain a decryption code from the machine tool builder and input it in the NC, then turn the power ON again.



## 2 Stop Codes (T)

<b>T01</b>	<b>Cycle start disabled (in SBT)</b>	0194
	<b>Details</b>	
	Cycle start is disabled because the break test is being executed for some axes in the system.	
	<b>Remedy</b>	
	•Execute cycle start after the break test is completed.	
<b>T01</b>	<b>Cycle start prohibit(in SBT)</b>	0197
	<b>Details</b>	
	Cycle start is disabled because the axis in brake test exists in the system.	
	<b>Remedy</b>	
	After the brake test completed, execute the cycle start.	
<b>T02</b>	<b>EMG stop</b>	0200
	<b>Details</b>	
	An emergency stop occurred during automatic operation.	
	<b>Remedy</b>	
	•After the emergency stop is canceled, the operation can be continued.	
<b>T02</b>	<b>H/W stroke end axis exists</b>	0201
	<b>Details</b>	
	An axis is at the stroke end.	
	<b>Remedy</b>	
	•Manually move the axis away from the stroke end limit switch. •Correct the machining program.	
<b>T02</b>	<b>S/W stroke end axis exists</b>	0202
	<b>Details</b>	
	An axis is at the stored stroke limit.	
	<b>Remedy</b>	
	•Manually move the axis. •Correct the machining program.	
<b>T02</b>	<b>Reset signal ON</b>	0203
	<b>Details</b>	
	The reset has been entered.	
	<b>Remedy</b>	
	•The program execution position has returned to the start of the program. Execute automatic operation from the start of the machining program.	
<b>T02</b>	<b>Auto operation pause signal ON</b>	0204
	<b>Details</b>	
	The "feed hold" switch is ON.	
	<b>Remedy</b>	
	•Press the CYCLE START switch to resume the automatic operation.	
<b>T02</b>	<b>Operation mode changed</b>	0205
	<b>Details</b>	
	The operation mode has changed to another mode during automatic operation.	
	<b>Remedy</b>	
	•Return to the original automatic operation mode, and press the CYCLE START switch to resume the automatic operation.	

<b>T02</b>	<b>Acc/dec time cnst too large</b>	0206
	<b>Details</b>	
		The acceleration and deceleration time constants are too large. (This alarm occurs with the system alarm Z59.)
	<b>Remedy</b>	
		<ul style="list-style-type: none"> <li>♦Set a larger value for "#1206 G1bF(Maximum speed)".</li> <li>♦Set a smaller value for "#1207 G1btL(Time constant)".</li> <li>♦Set a lower cutting speed.</li> </ul>
<b>T02</b>	<b>Abs posn detect alarm occurred</b>	0215
	<b>Details</b>	
		An absolute position detection alarm occurred.
	<b>Remedy</b>	
		♦Clear the absolute position detection alarm.
<b>T02</b>	<b>Aux axis changeover error</b>	0220
	<b>Details</b>	
		A travel command was issued to an auxiliary axis.
	<b>Remedy</b>	
		♦Turn ON the "NC axis control selection" signal and press the CYCLE START switch to restart the automatic operation with.
<b>T02</b>	<b>FEED HOLD: SOS axis</b>	0221
	<b>Details</b>	
		SOS axis exists in the system.
	<b>Remedy</b>	
		Cancel SOS state and execute cycle start, and you can continue automatic operation from the stop point.
<b>T03</b>	<b>Single block stop signal ON</b>	0301
	<b>Details</b>	
		The SINGLE BLOCK switch on the machine operation panel is ON. The SINGLE BLOCK or MACHINE LOCK switch changed.
	<b>Remedy</b>	
		♦Press the CYCLE START switch to resume the automatic operation.
<b>T03</b>	<b>Block stop cmnd in user macro</b>	0302
	<b>Details</b>	
		A block stop command was issued in the user macro program.
	<b>Remedy</b>	
		♦Press the CYCLE START switch to resume the automatic operation.
<b>T03</b>	<b>Operation mode changed</b>	0303
	<b>Details</b>	
		Automatic mode changed to another automatic mode.
	<b>Remedy</b>	
		♦Return to the original automatic operation mode, and press the CYCLE START switch to resume the automatic operation.
<b>T03</b>	<b>MDI completed</b>	0304
	<b>Details</b>	
		MDI operation has ended the last block.
	<b>Remedy</b>	
		♦Set the MDI operation again, and press the CYCLE START switch to start the MDI operation.

## 2 Stop Codes (T)

<b>T03</b>	<b>Block start interlock</b>	0305
	<b>Details</b>	
	The interlock signal, which locks the block start, is ON.	
	<b>Remedy</b>	
	•Correct the sequence program.	
<b>T03</b>	<b>Cutting blk start interlock</b>	0306
	<b>Details</b>	
	The interlock signal, which locks the block cutting start, is ON.	
	<b>Remedy</b>	
	•Correct the sequence program.	
<b>T03</b>	<b>Safe speed clamp is ON</b>	0308
	<b>Details</b>	
	One of the following commands was issued during the safe speed clamp: thread cutting, synchronous tapping, cross machining, superimposition control, tool center point control or SSS control.	
	<b>Remedy</b>	
	•Turn ON the safely-limited speed monitoring request signal before performing the operation.	
	•Perform the operation with the door closed.	
<b>T03</b>	<b>Inclined Z offset change</b>	0310
	<b>Details</b>	
	The "inclined axis control: No Z axis compensation" signal has turned ON or OFF during the program operation.	
	<b>Remedy</b>	
	•Press the CYCLE START switch to resume the automatic operation.	
<b>T03</b>	<b>Stop at selected point</b>	0320
	<b>Details</b>	
	Operation has stopped at the selected point.	
	<b>Remedy</b>	
	•Perform the automatic start to execute the program from the block.	
<b>T03</b>	<b>Aux axis changeover error</b>	0330
	<b>Details</b>	
	The "NC axis control selection" signal was turned OFF while a NC axis was traveling.	
	<b>Remedy</b>	
	•Turn the "NC axis control selection" signal ON and press the CYCLE START switch to resume the automatic operation.	
<b>T04</b>	<b>Collation stop</b>	0401
	<b>Details</b>	
	Collation stop occurred.	
	<b>Remedy</b>	
	•Execute the automatic start to resume the automatic operation.	

T10	Fin wait	(Factors for waiting completion)
<b>Details</b>		
<p>The following Nos. are shown during the operation of the corresponding completion wait factor. The numbers will disappear when the operation is completed. The completion wait factor is indicated with four digits (in hexadecimal).</p>		
<p>Display format of completion wait factor</p>		
<p>0 _ _ _ _ (a)(b)(c)</p>		
<p>Each of the hexadecimal numbers (a), (b) and (c) indicates the following details.</p>		
<p>(a) bit0: In dwell execution bit3: Unclamp signal wait (Note 1)</p> <p>(b) bit0: Waiting for spindle position to be looped bit3: Door open (Note 2)</p> <p>(c) bit0: Waiting for MSTB completion bit1: Waiting for rapid traverse deceleration bit2: Waiting for cutting speed deceleration bit3: Waiting for spindle orientation completion</p>		
<p>(Note 1) For type A (#1282 ext18/bit3 = 0) ♦Waiting for turning ON or OFF of the unclamp finish signal for the index table indexing.</p> <p>For type B (#1282 ext18/bit3 = 1) ♦Waiting for turning ON of the unclamp finish signal for the index table indexing. ♦Waiting for turning ON of the clamp finish signal for the index table indexing.</p> <p>(*) The complete standby status is established when the unclamp finish and clamp finish signals are both turned ON. Set the clamp finish signal to OFF after performing required process with the PLC.</p>		
<p>(Note 2) This shows the door open state caused by the door interlock function.</p>		
T11	Fin wait	(Factors for waiting completion)
<b>Details</b>		
<p>The following Nos. are shown during the operation of the corresponding completion wait factor. The numbers will disappear when the operation is completed. The completion wait factor is indicated with four digits (in hexadecimal).</p>		
<p>Display format of completion wait factor</p>		
<p>0 _ _ _ _ (a)(b)(c)</p>		
<p>Each of the hexadecimal numbers (a), (b) and (c) indicates the following details.</p>		
<p>(b) bit0: Operation alarm display being postponed</p>		
<b>Remedy</b>		
<p>♦The parameter "#1342 AlmDly" may be able to postpone displaying a part of an operation alarm, depending on the setting. This stop code will remain displayed while any alarm is being postponed. And it will disappear if the postponed alarm is displayed or canceled.</p>		



---

## Servo/Spindle Alarms (S)

### 3.1 Servo Errors (S01/S03/S04)

Servo alarm is displayed in the following format.

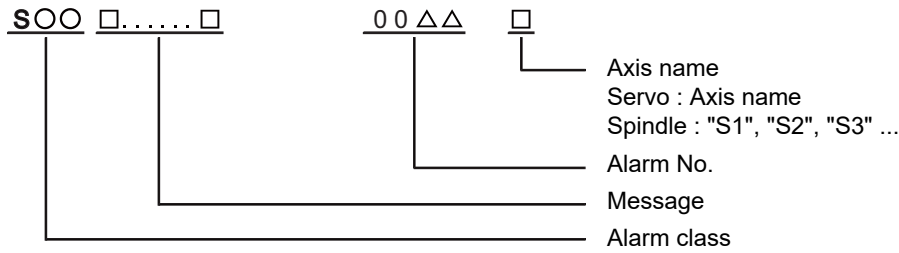

Alarm class	Message	Reset method	Resetting methods
S01	Name or "Servo alarm"	PR	After removing the cause of the alarm, reset the alarm by turning the NC power ON again.
S03	Name or "Servo alarm"	NR	After removing the cause of the alarm, reset the alarm by inputting the NC RESET key.
S04	Name or "Servo alarm"	AR	After removing the cause of the alarm, reset the alarm by turning the NC and drive unit power ON again.

The numerical value in the column of "No." in the table after the following page is the double-digit number displayed on the LED which is on the front-side of the drive unit.

At the time of the occurrence of the servo errors (S01/S03/S04), this number will be displayed in the last two digits of the "alarm number".

(Note 1) For the troubleshooting at the time of the occurrence of the servo errors, refer to your drive unit's instruction manual.

(Note 2) When multiple servo alarms have occurred, only an alarm which occurred first is displayed on the alarm screen. Refer to the alarm history on the drive monitor screen as necessary.

## 3 Servo/Spindle Alarms (S)

## (1) Drive unit alarm

No.	Name	Details	Reset method	Servo stop method	Spindle stop method
10	Insufficient voltage	A drop of bus voltage was detected in main circuit.	PR	Dynamic stop	Coast to a stop
11	Axis selection error	The axis selection rotary switch has been incorrectly set.	AR	Initial error	Initial error
12	Memory error 1	A hardware error was detected during the power ON self-check.	AR	Initial error	Initial error
13	Software processing error 1	An error was detected for the software execution state.	PR	Dynamic stop	Coast to a stop
14	Software processing error2	The current processor is not operating correctly.	AR	Dynamic stop	Coast to a stop
16	Initial magnetic pole position detection error	In the built-in motor which uses the absolute position encoder, the servo ON has been set before the magnetic pole shift amount is set. The magnetic pole position, detected in the initial magnetic pole position detection control, is not correctly set.	PR	Dynamic stop	Coast to a stop
17	A/D converter error	A current feedback error was detected.	PR	Dynamic stop	Coast to a stop
18	Main side encoder: Initial communication error	An error was detected in the initial communication with the motor side encoder.	PR	Initial error	Initial error
19	Encoder communication error in synchronous control	An error of the shared encoder on the machine side was detected on the secondary axis of the speed command synchronization control.	PR	Dynamic stop	-
1A	Sub side encoder: Initial communication error	An error was detected in the initial communication with the machine side encoder.	PR	Initial error	Initial error
1B	Sub side encoder: Error 1	An error was detected by the encoder connected to the machine side. The error details are different according to the encoder type. Refer to "Encoder alarm" for details.		Dynamic stop	Coast to a stop
1C	Sub side encoder: Error 2				
1D	Sub side encoder: Error 3				
1E	Sub side encoder: Error 4				
1F	Sub side encoder: Communication error	An error was detected in the communication with the machine side encoder.	PR	Dynamic stop	Coast to a stop
21	Sub side encoder no signal 2	In the machine side encoder, ABZ-phase feedback cannot be returned even when the motor moves.	PR	Dynamic stop	Coast to a stop
22	Encoder data error	An error was detected in the feedback data from the position encoder.	AR	Dynamic stop	Coast to a stop
23	Excessive speed error	The state that there is a difference between the actual speed and command speed continued for longer than the excessive speed deviation timer setting.	NR	-	Coast to a stop
24	Grounding	The motor power cable is in contact with FG (Frame Ground).	PR	Dynamic stop	Coast to a stop
25	Absolute position data lost	The absolute position data was lost in the encoder.	AR	Initial error	-
26	Unused axis error	In the multiaxis drive unit, there is an axis set to free, and the other axis detected a power module error.	PR	Dynamic stop	Coast to a stop

(Note 1) Definitions of terms in the table are as follows.

**Main side encoder:** Encoder connected to CN2

**Sub side encoder:** Encoder connected to CN3

(Note 2) Resetting methods

**NR:** Reset with the NC RESET button. This alarm can also be reset with the PR and AR resetting conditions.

**PR:** Reset by turning the NC power ON again. This alarm can also be reset with the AR resetting conditions. When the control axis is removed, this alarm can be reset with the NC RESET button. (Excluding alarms 32 and 37.)

**AR:** Reset by turning the NC and servo drive unit power ON again.



## 3 Servo/Spindle Alarms (S)

No.	Name	Details	Reset method	Servo stop method	Spindle stop method
27	Sub side encoder: Error 5	An error was detected by the encoder connected to the machine side. The error details are different according to the encoder type. Refer to "Encoder alarm" for details.		Dynamic stop	Coast to a stop
28	Sub side encoder: Error 6				
29	Sub side encoder: Error 7				
2A	Sub side encoder: Error 8				
2B	Main side encoder: Error 1	An error was detected by the encoder connected to the motor side. The error details are different according to the encoder type. Refer to "Encoder alarm" for details.		Dynamic stop	Coast to a stop
2C	Main side encoder: Error 2				
2D	Main side encoder: Error 3				
2E	Main side encoder: Error 4				
2F	Main side encoder: Communication error	An error was detected in the communication with the motor side encoder.	PR	Dynamic stop	Coast to a stop
30	Over regeneration	Over-regeneration level exceeded 100%. The regenerative resistor is overloaded.	PR	Dynamic stop	Coast to a stop
31	Overspeed	The motor speed exceeded the allowable speed.	PR	Deceleration stop	Deceleration stop
32	Power module error (overcurrent)	The power module detected the overcurrent.	PR	Dynamic stop	Coast to a stop
33	Overvoltage	The bus voltage in main circuit exceeded the allowable value.	PR	Dynamic stop	Coast to a stop
34	NC communication: CRC error	The data received from the NC was outside the setting range.	PR	Deceleration stop	Deceleration stop
35	NC command error	The travel command data received from the NC was excessive.	PR	Deceleration stop	Deceleration stop
36	NC communication: Communication error	The communication with the NC was interrupted.	PR	Deceleration stop	Deceleration stop
37	Initial parameter error	An incorrect set value was detected among the parameters send from the NC at the power ON. In the SLS(Safely Limited Speed) function, an error was detected in the relation between the safety speed and safety rotation number in the speed observation mode.	PR	Initial error	Initial error
38	NC communication: Protocol error 1	An error was detected in the communication frames received from the NC. Or, removing an axis or changing an axis was performed in the synchronous control.	PR	Deceleration stop	Deceleration stop
39	NC communication: Protocol error 2	An error was detected in the axis data received from the NC. Or, in changing an axis, the parameter setting of the synchronous control was applied when the axis was installed.	PR	Deceleration stop	Deceleration stop
3A	Overcurrent	Excessive motor drive current was detected.	PR	Dynamic stop	Coast to a stop
3B	Power module error (overheat)	The power module detected an overheat.	PR	Dynamic stop	Coast to a stop
3C	Regeneration circuit error	An error was detected in the regenerative transistor or in the regenerative resistor.	PR	Dynamic stop	-
3D	Power supply voltage error at acceleration/deceleration	A motor control error during acceleration/deceleration, due to a power voltage failure, was detected.	PR	Dynamic stop	-
3E	Magnetic pole position detection error	The magnetic pole position, detected in the magnetic pole position detection control, is not correctly detected.	AR	Dynamic stop	Coast to a stop

(Note 1) Definitions of terms in the table are as follows.

**Main side encoder:** Encoder connected to CN2

**Sub side encoder:** Encoder connected to CN3

(Note 2) Resetting methods

**NR:** Reset with the NC RESET button. This alarm can also be reset with the PR and AR resetting conditions.

**PR:** Reset by turning the NC power ON again. This alarm can also be reset with the AR resetting conditions. When the control axis is removed, this alarm can be reset with the NC RESET button. (Excluding alarms 32 and 37.)

**AR:** Reset by turning the NC and servo drive unit power ON again.

## 3 Servo/Spindle Alarms (S)

No.	Name	Details	Reset method	Servo stop method	Spindle stop method
41	Feedback error 3	Either a missed feedback pulse in the motor side encoder or an error in the Z-phase was detected in the full closed loop system.	PR	Dynamic stop	Coast to a stop
42	Feedback error 1	Either a missed feedback pulse in the position detection or an error in the Z-phase was detected. Or the distance-coded reference check error exceeded the allowable value when the distance-coded reference scale was used.	PR	Dynamic stop	Coast to a stop
43	Feedback error 2	An excessive difference in feedback was detected between the machine side encoder and the motor side encoder.	PR	Dynamic stop	Coast to a stop
45	Fan stop	An overheat of the power module was detected during the cooling fan stopping.	PR	Dynamic stop	Coast to a stop
46	Motor overheat / Thermal error	Either the motor or the motor side encoder detected an overheat. Or, the thermistor signal receiving circuit of the linear motor or direct-drive motor was disconnected. Or, the thermistor signal receiving circuit was short-circuited.	NR	Deceleration stop	Deceleration stop
48	Main side encoder: Error 5	An error was detected by the encoder connected to the main side. The error details are different according to the connected encoder. Refer to "Encoder alarm".		Dynamic stop	Coast to a stop
49	Main side encoder: Error 6				
4A	Main side encoder: Error 7				
4B	Main side encoder: Error 8				
4C	Current error at initial magnetic pole estimate	Current detection failed at the initial magnetic pole estimation.	NR	Dynamic stop	Coast to a stop
4D	Dual signal error	An error was detected in the signal related to the dual signal. Refer to "Dual signal error (4D)" for details.			
4E	NC command mode error	An error was detected in the control mode send from the NC.	NR	Deceleration stop	Deceleration stop
4F	Instantaneous power interrupt	The control power supply has remained shut down.	NR	Deceleration stop	Deceleration stop
50	Overload 1	Overload detection level became 100% or more. The motor or the drive unit is overloaded.	NR	Deceleration stop	Deceleration stop
51	Overload 2	In a servo system, current command of 95% or more of the unit's max. current was given continuously for 1 second or longer. In a spindle system, current command of 95% or more of the motor's max. current was given continuously for 1 second or longer.	NR	Deceleration stop	Deceleration stop
52	Excessive error 1	A position tracking error during servo ON was excessive.	NR	Deceleration stop	Deceleration stop
53	Excessive error 2	A position tracking error during servo OFF was excessive.	NR	Dynamic stop	-
54	Excessive error 3	There was no motor current feedback when the alarm "Excessive error 1" was detected.	NR	Dynamic stop	Coast to a stop
56	Commanded speed error	The encoder has detected that the commanded speed exceeded 1.15 times of the rapid traverse rate (rapid), or the motor rotation speed exceeded the maximum speed.	NR	Deceleration stop	Deceleration stop
58	Collision detection 1: G0	A disturbance torque exceeded the allowable value in rapid traverse modal (G0).	NR	Max cap dec stop	-
59	Collision detection 1: G1	A disturbance torque exceeded the allowable value in the cutting feed modal (G1).	NR	Max cap dec stop	-
5A	Collision detection 2	A current command with the maximum drive unit current value was detected.	NR	Max cap dec stop	-

(Note 1) Definitions of terms in the table are as follows.

**Main side encoder:** Encoder connected to CN2

**Sub side encoder:** Encoder connected to CN3

(Note 2) Resetting methods

**NR:** Reset with the NC RESET button. This alarm can also be reset with the PR and AR resetting conditions.

**PR:** Reset by turning the NC power ON again. This alarm can also be reset with the AR resetting conditions. When the control axis is removed, this alarm can be reset with the NC RESET button. (Excluding alarms 32 and 37.)

**AR:** Reset by turning the NC and servo drive unit power ON again.

## 3 Servo/Spindle Alarms (S)

No.	Name	Details	Reset method	Servo stop method	Spindle stop method
5B	Safely limited: Commanded speed monitoring error	A commanded speed exceeding the safely limited speed was detected in the safely limited mode.	PR	Deceleration stop	Deceleration stop
5D	Safely limited: Door state error	The door state signal input in the NC does not coincide with the door state signal input in the drive unit in the safely limited mode. Otherwise, door open state was detected in normal mode.	PR	Deceleration stop	Deceleration stop
5E	Safely limited: Speed feedback monitoring error	A motor speed exceeding the safely limited speed was detected in the safely limited mode.	PR	Deceleration stop	Deceleration stop
5F	External contactor error	A contact of the external contactor is welding.	NR	Deceleration stop	Deceleration stop
60, 61, 63 to 77	Power supply alarm	The power supply unit detected an error. The error details are different according to the connected power supply unit. Refer to "Power supply alarm" for details.		Dynamic stop	Coast to a stop
62	Power supply: Frequency error			Deceleration stop	Deceleration stop
80	Main side encoder cable error	The cable type of the motor side encoder cable is for rectangular wave signal.	AR	Initial error	-
81	Sub side encoder cable error	The cable type of the machine side encoder cable does not coincide with the encoder type which is set by the parameter.	AR	Initial error	-
87	Drivers communication error	The communication frame between drive units was aborted.	PR	Dynamic stop	Coast to a stop
88	Watchdog	The drive unit does not operate correctly. LED display is fixed as "88". "888" is displayed for MDS-EJ/EJH Series.	AR	Dynamic stop	Coast to a stop
8A	Drivers communication data error 1	The communication data 1 between drivers exceeded the tolerable value in the communication between drive units.	PR	Dynamic stop	Coast to a stop
8B	Drivers communication data error 2	The communication data 2 between drivers exceeded the tolerable value in the communication between drive units.	PR	Dynamic stop	Coast to a stop

(Note 1) Definitions of terms in the table are as follows.

**Main side encoder:** Encoder connected to CN2

**Sub side encoder:** Encoder connected to CN3

(Note 2) Resetting methods

**NR:** Reset with the NC RESET button. This alarm can also be reset with the PR and AR resetting conditions.

**PR:** Reset by turning the NC power ON again. This alarm can also be reset with the AR resetting conditions. When the control axis is removed, this alarm can be reset with the NC RESET button. (Excluding alarms 32 and 37.)

**AR:** Reset by turning the NC and servo drive unit power ON again.

## 3 Servo/Spindle Alarms (S)

## Encoder alarm (Servo drive unit)

Alarm number when the encoder is connected to CN2 side		2B	2C	2D	2E	48	49	4A	4B
Alarm number when the encoder is connected to CN3 side		1B	1C	1D	1E	27	28	29	2A
OSA405 OSA676 OSA24RS	Mitsubishi Electric	Memory alarm	LED alarm	Data alarm	Encoder thermal error	-	-	-	-
OSA405ET2AS OSA676ET2AS		Memory alarm	LED alarm	Data alarm	Encoder thermal error	-	-	-	-
MDS-EX-HR		Memory error	-	Data error	-	Scale not connected	-	-	-
AT343 AT543 AT545 AT1143 ST748	Mitsutoyo	Initialization error (bit0)	EEPROM error (bit5)	Photoelectric type, static capacity type data mismatch (bit1)	ROM/RAM error (bit6)	CPU error (bit4)	Photoelectric type over-speed (bit7)	Static capacity type error (bit3)	Photoelectric type error (bit2)
LC195M, LC495M, LC291M, LIC2197M, LIC2199M MC15 RCN2590M, RCN5390M, RCN5590M, RCN8390M ROC425M, ROC2390M ECA4000Series EIB Series	HEIDENHAIN	Initialization error (bit0)	EEPROM error (bit5)	Relative/absolute position data mismatch (bit1)	ROM/RAM error (bit6)	CPU error (bit4)	Overspeed (bit7)	Absolute position data error (bit3)	Relative position data error (bit2)
MPRZ scale	Mitsubishi Heavy Industries Machine Tool	Installation accuracy fault (bit4)	-	Detection position deviation (bit1)	Scale breaking (bit0)	Absolute position detection fault (bit5)	-	Gain fault (bit3)	Phase fault (bit2)
SR67A, SR75, SR85 SR74, SR77 SR87, SR84 RU77 RS87	Magnescale	Laser diode error (bit0)	System memory error (bit5)	Encoder mismatch error (bit1)	-	-	Over speed (bit7)	Absolute position data error (bit3)	Relative position data error (bit2)
SAM/SVAM/ GAM/G2AM/ LAM/HAM/H2AM Series	FAGOR	-	-	Absolute value detection error (bit3)	H/W error (bit1)	CPU error (bit0)	-	-	-
RL40N/RA/FOR- TiS Series	Renishaw	Initialization error (bit0)	-	Absolute position data error (bit3)	-	-	Over speed (bit7)	-	-
WMFA/WMBA/ WMRA/LMFA/ LMBA Series (Note)	AMO	Initialization error (bit0)	-	Relative/absolute position data mismatch (bit2)	-	-	Over speed (bit5)	Absolute position data error (bit6)	-
AMS-ABS-3B Series	Schneeberger	- (bit0)	-	-	Absolute position data error (bit3)	-	-	-	-

(Note 1) A drive unit processes all reset types of alarms as "PR". However, "AR" will be applied according to the encoder.

(Note 2) Bit No. in the table refers to a bit assignment for encoder side alarm management data.

## Encoder alarm (Spindle drive unit)

Alarm number when the encoder is connected to CN2 side		2B	2C	2D	2E	48	49	4A	4B
Alarm number when the encoder is connected to CN3 side		1B	1C	1D	1E	27	28	29	2A
TS5690 TS5691	Mitsubishi Electric	Memory error	Waveform error	-	-	-	Overspeed	-	Relative position data error
MDS-EX-HR		Initialization error	-	Data error	-	Connection error	-	-	-
OSA24RS		CPU error	Waveform error	Data alarm	Encoder thermal error	-	-	-	-
EIB Series	HEIDENHAIN	Initialization error (bit0)	EEPROM error (bit5)	-	-	CPU error (bit4)	Overspeed (bit7)	-	Relative position data error (bit2)
ADB-K70M	Mitsubishi Heavy Industries Machine Tool	Installation accuracy fault (bit4)	-	Detection position deviance (bit1)	Scale breaking (bit0)	-	-	Gain fault (bit3)	Phase fault (bit2)
GEL2449M	LE-NORD+BAUER	Waveform error (bit0)	Analog signal warning (bit1)	EEPROM error (bit2)	Power voltage warning (bit3)	H/W error (bit4)	Overspeed warning (bit5)	Count error (bit6)	Overheat warning (bit7)

(Note 1) A drive unit processes all reset types of alarms as "PR". However, "AR" will be applied according to the encoder.

(Note 2) Bit No. in the table refers to a bit assignment for encoder side alarm management data.

## 3 Servo/Spindle Alarms (S)

## Dual signal error (4D)

No.	Name	Sub info	Details
004D.xxx	Dual signal error	-	An error was detected in the signal related to the dual signal. The name of the axis with an error is displayed. The number "xxx" in the decimal place indicates the sub-number.

(Note) Resetting method may be "PR" depending on the sub-number in the decimal place.

## 004D.xxx : Alarm number.Sub-number

Sub-No.	Name	Details	Reset method	Axis type	Servo stop method	Spindle stop method
1	Power shutoff error	Either of the STO signals entered an input state while the STO function is disabled.	NR	Each axis	Dynamic stop	Coast to a stop
2	Illegal power shutoff error	Either of the STO signals entered an input state during servo ON command or during deceleration and stop with the STO function enabled.	NR	Each axis	Dynamic stop	Coast to a stop
3	STO signal mismatch error	Input states of two STO signals were mismatched while the STO function is enabled.	NR	Each axis	Dynamic stop	Coast to a stop
15	Safety communication: Communication error 1	A receiving error was detected in the safety communication.	NR	Each axis	Dynamic stop	Coast to a stop
16	Safety communication: Initial communication error 1	A receiving error was detected in the initial communication for the safety communication.	PR	Each axis	Dynamic stop	Coast to a stop
17	Voltage diagnosis error	A power error was detected in the safety function.	NR	Each axis	Dynamic stop	Coast to a stop
19	DRAM diagnosis error	A DRAM error was detected in the safety function.	PR	Each axis	Dynamic stop	Coast to a stop
21	Control process error	An error was detected in the status of software execution for the safety function.	PR	Each axis	Dynamic stop	Coast to a stop
23	Safety encoder: Initial communication error 1	An error was detected in the initial communication with a safety encoder.	PR	Each axis	Initial error	Initial error
24	PCB error	A PCB error was detected in the safety function.	PR	Each axis	Initial error	Initial error
25	Synchronization error	A synchronization error was detected in the safety function.	PR	Each axis	Dynamic stop	Coast to a stop
26	Flash ROM diagnosis error	A Flash ROM error was detected in the safety function.	PR	Each axis	Initial error	Initial error
33	Safety encoder: Communication error 1	An error was detected in the communication with a safety encoder.	PR	Each axis	Dynamic stop	Coast to a stop
34	Safety encoder: Diagnosis error 1	A power supply voltage error was detected in the safety encoder.	PR	Each axis	Dynamic stop	Coast to a stop
35	Safety encoder: Diagnosis error 2	A H/W error was detected in the safety encoder.	PR	Each axis	Dynamic stop	Coast to a stop
36	Safety encoder: Diagnosis error 3	A process error was detected in the safety encoder.	PR	Each axis	Dynamic stop	Coast to a stop
37	Safety encoder: Diagnosis error 4	An A/D conversion error was detected in the safety encoder.	PR	Each axis	Dynamic stop	Coast to a stop
39	Non-safety encoder: Position feedback fixation diagnosis error	The position feedback from the non-safety encoder remains unchanged.	PR	Each axis	Dynamic stop	Coast to a stop
40	Safety encoder: Thermal error	The safety encoder detected a thermal error.	PR	Each axis	Dynamic stop	Coast to a stop
53	Safety communication: Transmission interval mismatch error	An error was detected in the transmission interval setting.	NR	Each axis	Initial error	Initial error
54	Safety communication: Initial communication error 2	A receiving error was detected in the initial communication for the safety communication.	NR	Each axis	Initial error	Initial error
55	Safety communication: Communication error 2	A receiving error was detected in the safety communication.	NR	Each axis	Dynamic stop	Coast to a stop
56	Safety parameter setting range error	A setting error was detected in the safety parameter.	PR	Each axis	Initial error	Initial error
57	Safety parameter combination error	A combination error was detected in the safety parameter.	PR	Each axis	Initial error	Initial error
65	Register diagnosis error	A register diagnosis error was detected in the safety function.	PR	Each axis	Initial error	Initial error

## 3 Servo/Spindle Alarms (S)

## 004D.xxx : Alarm number.Sub-number

Sub-No.	Name	Details	Reset method	Axis type	Servo stop method	Spindle stop method
66	Calculation device diagnosis error	An error was detected in the calculation device diagnosis for the safety function.	PR	Each axis	Initial error	Initial error
67	Sequence diagnosis error	An error was detected in the sequence diagnosis for the safety function.	PR	Each axis	Dynamic stop	Coast to a stop
68	Stack diagnosis error	An error was detected in the stack diagnosis for the safety function.	PR	Each axis	Dynamic stop	Coast to a stop
69	Temperature diagnosis error	Overheat was detected in the safety function.	NR	Each axis	Dynamic stop	Coast to a stop
71	Watchdog error	The safety function is not operating correctly.	PR	Each axis	Dynamic stop	Coast to a stop
72	Clock diagnosis error	An error was detected in the clock diagnosis for the safety function.	PR	Each axis	Dynamic stop	Coast to a stop
74	DO output compare error	An error was detected in the status of DO output for the safety function.	PR	Each axis	Dynamic stop	Coast to a stop
75	ISC communication error	An error was detected in the inter-system communication for the safety function.	PR	Each axis	Dynamic stop	Coast to a stop
78	Safety communication: Initial communication error 3	A receiving error was detected in the initial communication for the safety communication.	PR	Each axis	Dynamic stop	Coast to a stop
88	Safety circuit: STO error	An error was detected in the read-back diagnosis for STO.	PR	Each axis	Dynamic stop	Coast to a stop
91	Safety circuit: SBC error	An error was detected in the read-back diagnosis for SBC.	PR	Each axis	Dynamic stop	Coast to a stop
126	Safety communication: Communication error 3	A receiving error was detected in the safety communication.	PR	Each axis	Dynamic stop	Coast to a stop

## (2) Power supply alarm

No.	Name	Details	Reset method
61	Power supply: Power module overcurrent	Overcurrent protection function in the power module has started its operation.	PR
62	Power supply: Frequency error	The input power supply frequency increased above the specification range.	PR
66	Power supply: Process error	An error occurred in the process cycle.	PR
67	Power supply: Phase interruption	An open-phase condition was detected in input power supply circuit.	PR
68	Power supply: Watchdog	The system does not operate correctly. LED display is fixed as "8".	AR
69	Power supply: Grounding	The motor power cable is in contact with FG (Frame Ground).	PR
6A	Power supply: External contactor welding	A contact of the external contactor is welding.	PR
6B	Power supply: Rush circuit error	An error was detected in the rush circuit.	PR
6C	Power supply: Main circuit error	An error was detected in charging operation of the main circuit capacitor.	PR
6D	Parameter setting error	An error was detected in the parameter sent from the drive unit.	PR
6E	Power supply: H/W error	An error was detected in the internal memory.	AR
	A/D error	An error was detected in the A/D converter.	
	Unit ID error	An error was detected in the unit identification.	
6F	Power supply error	No power supply is connected to the drive unit, or a communication error was detected.	AR (Note 4)
70	Power supply: External emergency stop error	A mismatch of the external emergency stop input and NC emergency stop input continued for 30 seconds.	PR
71	Power supply: Instantaneous power interruption	The power was momentarily interrupted.	NR
72	Power supply: Fan stop	A cooling fan built in the power supply unit stopped, and overheat occurred in the power module.	PR
73	Power supply: Over regeneration	Over-regeneration detection level became over 100%. The regenerative resistor is overloaded. This alarm cannot be reset for 15 min from the occurrence to protect the regeneration resistor. Leave the drive system energized for more than 15 min, then turn the power ON to reset the alarm.	NR
74	Power supply: Option unit error	An alarm was detected in the power backup unit (power supply option unit).	NR (Note 3)
75	Power supply: Overvoltage	L+ and L- bus voltage in main circuit exceeded the allowable value. As the voltage between L+ and L- is high immediately after this alarm, another alarm may occur if this alarm is reset in a short time. Wait more than 5 min before resetting so that the voltage drops.	NR
76	Power supply: Function setting error	The rotary switch setting of external emergency stop is not correct, or a wrong external emergency stop signal is input.	AR
	Power supply: Function selection error	Undefined area for the rotary switch is selected	
77	Power supply: Power module overheat	Thermal protection function in the power module has started its operation.	PR

(Note 1) If a power supply alarm (60 to 77) occurs, all servos will stop with the dynamic brakes, and all spindles will coast to a stop.

(Note 2) "b", "C" and "d" displayed on the power supply unit's LED as a solid light (not flickering) do not indicate an alarm.

(Note 3) Check the LED display of the power backup unit to identify what alarm is occurring to the power backup unit.

\*\* Refer to your drive unit's instruction manual for details.

(Note 4) When the power supply alarm (6F) is detected in the 2nd part system, the reset method differs depending on the detected power supply alarm.



## 3.2 Initial Parameter Errors (S02)

<b>S02</b>	<b>Initial parameter error</b>	2201-2264	(Axis name)
<b>Details</b>			
The servo parameter setting data is illegal. The alarm No. is the No. of the servo parameter where the error occurred.			
<b>Remedy</b>			
Check the descriptions for the appropriate servo parameters and correct them. Refer to "Parameter Numbers during Initial Parameter Error" of each drive unit instruction manual for details.			
<b>S02</b>	<b>Initial parameter error</b>	2301	(Axis name)
<b>Details</b>			
The number of constants to be used in the following functions is too large: Electronic gears. Position loop gain. Speed feedback conversion.			
<b>Remedy</b>			
Check that all the related parameters are specified correctly. sv001:PC1, sv002:PC2, sv003:PGN1 sv018:PIT, sv019:RNG1, sv020:RNG2			
<b>S02</b>	<b>Initial parameter error</b>	2302	(Axis name)
<b>Details</b>			
When high-speed serial incremental encoder (OSE104, OSE105) is connected, parameters for absolute position are set to ON. Set the parameters for absolute position detection to OFF. To detect an absolute position, replace the incremental specification encoder with an absolute encoder.			
<b>Remedy</b>			
Check that all the related parameters are specified correctly. sv017:SPEC, sv025:MTYP			
<b>S02</b>	<b>Initial parameter error</b>	2303	(Axis name)
<b>Details</b>			
No servo option is found. The closed loop (including the ball screw-end detection) or dual feedback control is an optional function.			
<b>Remedy</b>			
Check that all the related parameters are specified correctly. sv025:MTYP/pen sv017:SPEC/dfbx			
<b>S02</b>	<b>Initial parameter error</b>	2304	(Axis name)
<b>Details</b>			
No servo option is found. The SHG control is an optional function.			
<b>Remedy</b>			
Check that all the related parameters are specified correctly. sv057:SHGC sv058:SHGCsp			
<b>S02</b>	<b>Initial parameter error</b>	2305	(Axis name)
<b>Details</b>			
No servo option is found. The adaptive filtering is an optional function.			
<b>Remedy</b>			
Check that all the related parameters are specified correctly. sv027:SSF1/afft			

S02	Initial parameter error:PR	13001-13256	(Axis name)
<b>Details</b>			
Parameter error The spindle parameter setting data is illegal. The alarm No. is the No. of the spindle parameter where the error occurred.			
<b>Remedy</b>			
Check the descriptions for the appropriate spindle parameters and correct them. Even when the parameter is set to a value within the setting range, an error is occurring due to the hardware compatibility or specifications or in relation to several other parameters. Refer to "Parameter Numbers during Initial Parameter Error" of each drive unit instruction manual for details.			

### 3.3 Safety Function Errors (S05)

<b>S05</b>	<b>Safety function error</b>	0001	(Axis name)
<b>Details</b>			
The STO signal has been input through the CN8 connector.			
<b>Remedy</b>			
Make sure that a short-circuiting connector has been inserted into CN8.			
<b>S05</b>	<b>Safety function error</b>	0002	(Axis name)
<b>Details</b>			
STO signal is input by dedicated wiring STO function during servo ON.			
<b>Remedy</b>			
Refer to the manual of drive unit.			
<b>S05</b>	<b>Safety function error</b>	0004	(Axis name)
<b>Details</b>			
STO signal is illegally input by dedicated wiring STO function during servo OFF. (Illegal input : Signal input state for STO1 and STO2 is mismatched.)			
<b>Remedy</b>			
Refer to the manual of drive unit.			
<b>S05</b>	<b>Safety function error</b>	0006	(Axis name)
<b>Details</b>			
STO signal is illegally input by dedicated wiring STO function during servo ON. (Illegal input : Signal input state for STO1 and STO2 is mismatched.)			
<b>Remedy</b>			
Refer to the manual of drive unit.			

### 3.4 Parameter Errors (S51)

S51	Parameter error	2201-2264	(Axis name)
	<p><b>Details</b></p> <p>Servo parameter setting data is illegal. The alarm No. is the No. of the servo parameter where the warning occurred.</p> <p><b>Remedy</b></p> <p>Check the descriptions for the appropriate servo parameters and correct them.</p>		
S51	Parameter error	13001-13256	(Axis name)
	<p><b>Details</b></p> <p>Spindle parameter setting data is illegal. The alarm No. is the No. of the spindle parameter where the warning occurred.</p> <p><b>Remedy</b></p> <p>Check the descriptions for the appropriate spindle parameters and correct them. Even when the parameter is set to a value within the setting range, an error is occurring due to the hardware compatibility or specifications or in relation to several other parameters. Refer to "Parameter Numbers during Initial Parameter Error" of each drive unit instruction manual for details.</p>		

### 3.5 Servo Warnings (S52)

Servo warning is displayed in the following format.

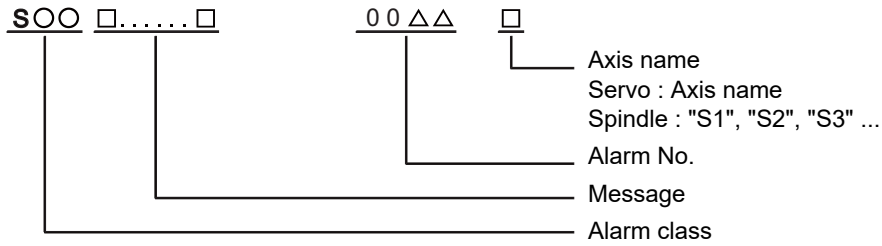

Alarm class	Message
S52	Name or "Servo warning"

The numerical value in the column of "No." in the table after the following page is the double-digit number displayed on the LED which is on the front-side of the drive unit.

At the time of the occurrence of the servo warnings (S52), this number will be displayed in the last two digits of the "alarm number".

(Note 1) For the troubleshooting at the time of the occurrence of the servo warnings, refer to your drive unit's instruction manual.

(Note 2) When multiple servo alarms have occurred, only an alarm which occurred first is displayed on the alarm screen. Refer to the alarm history on the drive monitor screen as necessary.

## 3 Servo/Spindle Alarms (S)

## (1) Drive unit warning

No.	Name	Details	Reset method	Stop method
96	Scale feedback error	An excessive difference in feedback amount was detected between the main side encoder and the MPI scale in MPI scale absolute position detection system.	*	-
97	Scale offset error	An error was detected in the offset data that is read at the NC power-ON in MPI scale absolute position detection system.	PR	-
9B	Incremental encoder/ magnetic pole shift warning	The difference between the magnetic pole position after the phase Z has been passed (magnetic pole shift amount:SV028) and the initially detected position is excessive in the built-in motor's incremental control system. The magnetic pole is controlled by the initial detection value.	PR	-
9E	Absolute position encoder: Revolution counter error	An error was detected in the revolution counter data of the absolute position encoder. The accuracy of absolute position is not guaranteed.	*	-
9F	Battery voltage drop	The battery voltage to be supplied to the absolute position encoder is dropping.	NR	-
A3	In initial setup of ABS position	This warning is detected until the axis reaches the reference position during the initial setup of the distance-coded reference check function. This warning turns OFF after the axis has reached the position, thus set the value displayed on the drive monitor to the parameter.	PR	-
A4	Dual signal warning	An input was detected in the signal related to the dual signal. Refer to "Dual signal warning (A4)" for details.	*	-
A6	Fan stop warning	A cooling fan in the drive unit stopped.	*	-
E0	Overregeneration warning	Over-regeneration detection level exceeded 80%.	*	-
E1	Overload warning	A level of 80% of the Overload 1 alarm state was detected.	*	-
E4	Parameter warning	An incorrect set value was detected among the parameters send from the NC in the normal operation.	*	-
E6	Control axis detachment warning	A control axis is being detached. (State display)	*	-
E7	NC emergency stop	In NC emergency stop. (State display)	*	Dec stop enabled
E8 to EF	Power supply warning	The power supply unit detected a warning. The error details are different according to the connected power supply unit. Refer to "Power supply warning".	*	- *EA: Dec stop enabled

(Note1) Definitions of terms in the table are as follows.

**Main side encoder:** Encoder connected to CN2

**Sub side encoder:** Encoder connected to CN3

(Note 2) Resetting methods

\* : Automatically reset once the cause of the warning is removed.

NR: Reset with the NC RESET button. This warning can also be reset with the PR and AR resetting conditions.

PR: Reset by turning the NC power ON again. This warning can also be reset with the AR resetting conditions. When the control axis is removed, this warning can be reset with the NC RESET button. (Excluding warning 93.)

AR: Reset by turning the NC and servo drive unit power ON again.

(Note 3) Servo and spindle motor do not stop when the warning occurs.

(Note 4) When an emergency stop is input, servo and spindle motor decelerate to a stop. (When SV048, SV055 or SV056 is set for servo and when SP055 or SP056 is set for spindle.)

## Dual signal warning (A4)

No.	Name	Sub info	Details
00A4.00	Dual signal warning	Axis name	The system has been set in the STO state. The STO state is also entered at the time of emergency stop, but in this case, this warning will not appear because the emergency stop has priority.

## (2) Power supply warning

No.	Name	Details	Reset method
E9	Instantaneous power interruption warning	The power was momentarily interrupted.	NR
EA	In external emergency stop state	External emergency stop signal was input.	*
EB	Power supply: Over regeneration warning	Over-regeneration detection level exceeded 80%.	*
EE	Power supply: Fan stop warning	A cooling fan built in the power supply unit stopped.	*
EF	Power supply: Option unit warning	A warning was detected in the power backup unit (power supply option unit).	* (Note 3)

## (Note 1) Resetting methods

\* : Automatically reset once the cause of the warning is removed.

NR: Reset with the NC RESET button. This warning can also be reset with the PR and AR resetting conditions.

PR: Reset by turning the NC power ON again. This warning can also be reset with the AR resetting conditions. When the control axis is removed, this warning can be reset with the NC RESET button. (Excluding warning 93.)

AR: Reset by turning the NC and servo drive unit power ON again.

(Note 2) Servo and spindle motor do not stop when the warning occurs.

(Note 3) Check the LED display of the power backup unit to identify what warning is occurring to the power backup unit.

\*\* Refer to your drive unit's instruction manual for details.

### 3.6 Safety Function Warnings (S53)

S53	Safety function warning	0001	(Axis name)
	<b>Details</b> The system has been set in the STO state. The STO state is also entered at the time of emergency stop, but in this case, this warning will not appear because the emergency stop has priority.		





## MCP Alarms (Y)

<b>Y02</b>	<b>System alm: Process time over</b>	0050	
	<b>Details</b>		
	System alarm: Process time is over.		
	<b>Remedy</b>		
	The software or hardware may be damaged. Contact the service center.		
	(Note) When two or more alarms (Y02 0051) occur at the same time, only the alarm which has occurred first is displayed.		
<b>Y02</b>	<b>SV commu er: Data ID error</b>	0051	xy03
	<b>Details</b>		
	A communication error has occurred between controller and drive unit. x: Channel No. (0 to) y: Drive unit rotary switch No. (0 to)		
	<b>Remedy</b>		
	<ul style="list-style-type: none"> <li>•Take measures against noise.</li> <li>•Check for any failure of the communication cable connectors between controller and drive unit or between two drive units.</li> <li>•Check for any failure of the communication cables between controller and drive unit or between two drive units.</li> <li>•A drive unit may be faulty. Take a note of the 7-segment LED contents of each drive unit and contact the Service Center.</li> <li>•Update the drive unit software version.</li> </ul>		
	(Note) When two or more alarms (Y02 0051) occur at the same time, only the alarm which has occurred first is displayed.		
<b>Y02</b>	<b>SV commu er: Recv frame No.</b>	0051	xy04
	<b>Details</b>		
	A communication error has occurred between controller and drive unit. x: Channel No. (from 0) y: Drive unit rotary switch No. (from 0)		
	<b>Remedy</b>		
	<ul style="list-style-type: none"> <li>•Take measures against noise.</li> <li>•Check for any failure of the communication cable connectors between controller and drive unit or between two drive units.</li> <li>•Check for any failure of the communication cables between controller and drive unit or between two drive units.</li> <li>•A drive unit may be faulty. Take a note of the 7-segment LED contents of each drive unit and contact the Service Center.</li> <li>•Update the drive unit software version.</li> </ul>		
	(Note) When two or more alarms (Y02 0051) occur at the same time, only the alarm which has occurred first is displayed.		
<b>Y02</b>	<b>SV commu er: Commu error</b>	0051	x005
	<b>Details</b>		
	A communication error has occurred between controller and drive unit. x: Channel No. (from 0)		
	<b>Remedy</b>		
	<ul style="list-style-type: none"> <li>•Take measures against noise.</li> <li>•Check for any failure of the communication cable connectors between controller and drive unit or between two drive units.</li> <li>•Check for any failure of the communication cables between controller and drive unit or between two drive units.</li> <li>•A drive unit may be faulty. Take a note of the 7-segment LED contents of each drive unit and contact the Service Center.</li> <li>•Update the drive unit software version.</li> </ul>		
	(Note) When two or more alarms (Y02 0051) occur at the same time, only the alarm which has occurred first is displayed.		

Y02	SV commu er: Connect error	0051	x006
<b>Details</b>			
A communication error has occurred between controller and drive unit. x: Channel No. (from 0)			
<b>Remedy</b>			
<ul style="list-style-type: none"> <li>♦Take measures against noise.</li> <li>♦Check for any failure of the communication cable connectors between controller and drive unit or between two drive units.</li> <li>♦Check for any failure of the communication cables between controller and drive unit or between two drive units.</li> <li>♦A drive unit may be faulty. Take a note of the 7-segment LED contents of each drive unit and contact the Service Center.</li> <li>♦Update the drive unit software version.</li> </ul>			
(Note) When two or more alarms (Y02 0051) occur at the same time, only the alarm which has occurred first is displayed.			
Y02	SV commu er: Safe posn FB err	0051	x007
<b>Details</b>			
A communication error has occurred between controller and drive unit. x: Channel No. (from 0)			
<b>Remedy</b>			
<ul style="list-style-type: none"> <li>♦Take measures against noise.</li> <li>♦Check for any failure of the communication cable connectors between controller and drive unit or between two drive units.</li> <li>♦Check for any failure of the communication cables between controller and drive unit or between two drive units.</li> <li>♦A drive unit may be faulty. Take a note of the 7-segment LED contents of each drive unit and contact the Service Center.</li> <li>♦Update the drive unit software version.</li> </ul>			
(Note) When two or more alarms (Y02 0051) occur at the same time, only the alarm which has occurred first is displayed.			
Y02	SV commu er : Init commu error	0051	xy20
<b>Details</b>			
A communication error has occurred between controller and drive unit. A drive unit stopped due to transition failure from initial communication to runtime. x: Channel No. (from 0) y: Drive unit rotary switch No. (from 0)			
<b>Remedy</b>			
<ul style="list-style-type: none"> <li>♦Take measures against noise.</li> <li>♦Check for any failure of the communication cable connectors between controller and drive unit or between two drive units.</li> <li>♦Check for any failure of the communication cables between controller and drive unit or between two drive units.</li> <li>♦A drive unit may be faulty. Take a note of the 7-segment LED contents of each drive unit and contact the Service Center.</li> <li>♦Update the drive unit software version.</li> </ul>			
(Note) When two or more alarms (Y02 0051) occur at the same time, only the alarm which has occurred first is displayed.			

Y02	SV commu er: Node detect err	0051	xy30
<b>Details</b>			
A communication error has occurred between controller and drive unit. No response from drive unit to the request from NC when setting network configuration. x: Channel No. (from 0) y: Station No. (from 0)			
<b>Remedy</b>			
<ul style="list-style-type: none"> <li>•Take measures against noise.</li> <li>•Check for any failure of the communication cable connectors between controller and drive unit or between two drive units.</li> <li>•Check for any failure of the communication cables between controller and drive unit or between two drive units.</li> <li>•A drive unit may be faulty. Take a note of the 7-segment LED contents of each drive unit and contact the Service Center.</li> <li>•Update the drive unit software version.</li> </ul>			
(Note) When two or more alarms (Y02 0051) occur at the same time, only the alarm which has occurred first is displayed.			
Y02	SV commu er: Commu not support	0051	xy31
<b>Details</b>			
A communication error has occurred between controller and drive unit. Drive unit's software version doesn't support the communication mode that the controller requires. x: Channel No. (from 0) y: Station No. (from 0)			
<b>Remedy</b>			
<ul style="list-style-type: none"> <li>•Take measures against noise.</li> <li>•Check for any failure of the communication cable connectors between controller and drive unit or between two drive units.</li> <li>•Check for any failure of the communication cables between controller and drive unit or between two drive units.</li> <li>•A drive unit may be faulty. Take a note of the 7-segment LED contents of each drive unit and contact the Service Center.</li> <li>•Update the drive unit software version.</li> </ul>			
(Note) When two or more alarms (Y02 0051) occur at the same time, only the alarm which has occurred first is displayed.			
Y03	Drive unit unequipped	axis name	
<b>Details</b>			
The drive unit is not correctly connected.			
Alphabet (axis name): NC axis drive unit not mounted			
Pn: PLC axis drive unit not mounted (n = axis No.)			
Sn: Spindle axis drive unit not mounted (n = axis No.)			
<b>Remedy</b>			
Check the drive unit mounting state.			
<ul style="list-style-type: none"> <li>•Check the end of the cable wiring.</li> <li>•Check for any broken wires.</li> <li>•Check the connector insertion.</li> <li>•The drive unit input power has not been ON.</li> <li>•The drive unit axis No. switch is illegal.</li> </ul>			

Y05	Initial parameter error	(Parameter No.)
	<p><b>Details</b></p> <p>There is a problem in the value set for the number of axes or the number of part systems.</p> <p><b>Remedy</b></p> <p>Correct the value set for the following corresponding parameters:  "#1001 SYS_ON (System validation setup)",  "#1002 axisno (Number of axes)",  "#1039 spinno (Number of spindles)", etc.  "#2187 chgPLCax (PLC axis switchover axis No.)", etc.</p> <p>•Make sure that the parameters unavailable for a switchover axis (#1068 slavno, #12800 chgauxno, etc.) are OFF.</p>	
Y05	Initial parameter error	2674 (Sub-number)
	<p><b>Details</b></p> <p>The parameter setting of the multiple axis synchronization control is incorrect.  The sub-number is displayed after the error number.</p> <p>0002:  More than three sets combining the synchronization control and the multiple axis synchronization control are set.</p> <p>0003:  The slave axis of multiple axis synchronization control overlaps with the synchronization control axis.</p> <p>0004:  The master axis of multiple axis synchronization control overlaps with the synchronization control axis.</p> <p>0005:  The master axis is set to the axis which crosses the part system.</p> <p>0006:  The slave axis setting is also set to the master axis.</p> <p>0007:  The function which cannot be used with the multiple axis synchronization control is enabled.</p> <p><b>Remedy</b></p> <p>Correct the parameter setting.</p>	
Y06	mcp_no setting error	0001
	<p><b>Details</b></p> <p>There is a skipped number in the channels.</p> <p><b>Remedy</b></p> <p>Check the values set for the following parameters.  "#1021 mcp_no (Drive unit I/F channel No. (servo))"  "#3031 smcp_no (Drive unit I/F channel No. (spindle))"</p>	
Y06	mcp_no setting error	0002
	<p><b>Details</b></p> <p>There is a duplicate setting for random layout.</p> <p><b>Remedy</b></p> <p>Check the values set for the following parameters.  "#1021 mcp_no (Drive unit I/F channel No. (servo))"  "#3031 smcp_no (Drive unit I/F channel No. (spindle))"</p>	
Y06	mcp_no setting error	0003
	<p><b>Details</b></p> <p>The drive unit fixed setting "0000" and random layout setting "*****" are both set.</p> <p><b>Remedy</b></p> <p>Check the values set for the following parameters.  "#1021 mcp_no (Drive unit I/F channel No. (servo))"  "#3031 smcp_no (Drive unit I/F channel No. (spindle))"</p>	

<b>Y06</b>	<b>mcp_no setting error</b>	0004
<b>Details</b>		
The spindle/C axis "#1021 mcp_no (Drive unit I/F channel No. (servo))" and "#3031 smcp_no (Drive unit I/F channel No. (spindle))" are not set to the same values.		
<b>Remedy</b>		
Check the values set for the following parameters. "#1021 mcp_no (Drive unit I/F channel No. (servo))" "#3031 smcp_no (Drive unit I/F channel No. (spindle))"		
<b>Y06</b>	<b>mcp_no setting error</b>	0005
<b>Details</b>		
A random layout has been set while "#1154 pdoor" has been set to "1" in two-part system.		
<b>Remedy</b>		
Check the values set for the following parameters. "#1021 mcp_no (Drive unit I/F channel No. (servo))" "#3031 smcp_no (Drive unit I/F channel No. (spindle))"		
<b>Y06</b>	<b>mcp_no setting error</b>	0006
<b>Details</b>		
The channel No. parameter is not within the setting range.		
<b>Remedy</b>		
Check the values set for the following parameters. "#1021 mcp_no (Drive unit I/F channel No. (servo))" "#3031 smcp_no (Drive unit I/F channel No. (spindle))"		
<b>Y07</b>	<b>Too many axes connected</b>	00xy
<b>Details</b>		
The drive units more than the number of axes specified with the parameter are connected.		
Or the number of axes connected to each channel exceeds the maximum number of connectable axes.		
The exceeded number of axes per channel is displayed as alarm No.		
x: Exceeded number of axes at drive unit interface channel 2 (0 to F)		
y: Exceeded number of axes at drive unit interface channel 1 (0 to F)		
This alarm also occurs when the drive unit is connected only with the 2nd channel without connecting with the 1st channel.		
<b>Remedy</b>		
For the channel whose alarm No. is other than "0", detach the connected axes by the number of indicated alarm No.		
The number of connected axes should be less than or equal to the number specified with the parameter or the maximum number of connections.		
(Note 1) The number of axes is limited per each drive unit interface channel.		
(Note 2) Maximum number of axes that can be connected differs depending on whether or not an expansion unit is available or the setting of "#11012 16 axes for 1ch" (Connecting 16 axes for 1ch). With the expansion unit, up to eight axes can be connected to a channel. Without the expansion unit, up to eight axes are allowed when "#11012 16 axes for 1ch" (Connecting 16 axes for 1ch) is set to "0", sixteen axes when set to "1".		
(Note 3) If this alarm occurs, the alarm "Y03 Message: Drive unit unequipped" will not occur.		
(Note 4) This alarm is displayed taking precedence over the alarm "Y08 Too many drive units connected" and "Y09 Too many axisno connected".		

Y08	Too many drive units connected	00xy
<b>Details</b>		
<p>The number of drive units connected to each channel exceeds 8.            The exceeded number of drive units per channel is displayed as alarm No.</p> <p>x: Exceeded number of drive units at drive unit interface channel 2 (0 to F)            y: Exceeded number of drive units at drive unit interface channel 1 (0 to F)</p>		
<b>Remedy</b>		
<p>Remove drive units from the channel whose alarm No. is other than "0" for the number displayed as the alarm No. Keep the number of connected drive units to 8 or less.</p> <p>(Note 1) The drive unit is not counted when all the axes connected to it are invalid.            (Note 2) If this alarm occurs, the alarm "Y03 Message: Drive unit unequipped" will not occur.            (Note 3) The alarm "Y07 Too many axes connected" and "Y09 Too many axisno connected" are displayed taking precedence over this alarm.</p>		
Y09	Too many axisno connected	00xy
<b>Details</b>		
<p>The No. of the axis (drive unit's rotary switch No.) connected to each channel is bigger than the No. allowed. If the axis No. of each channel is bigger than the No. allowed, "1" is displayed for the alarm No.</p> <p>x: "1" when the axis No. at drive unit interface channel 2 is too big            y: "1" when the axis No. at drive unit interface channel 1 is too big</p>		
<b>Remedy</b>		
<p>For the channel whose alarm No. is "1", keep the axis No. (drive unit's rotary switch No.) not bigger than the No. allowed.</p> <p>(Note 1) The axis No. is limited per each drive unit interface channel.            (Note 2) The biggest allowed connected axis No. differs depending on whether or not an expansion unit is available or the setting of "#11012 16 axes for 1ch (Connecting 16 axes for 1ch)". The biggest connectable axis No. is as shown below.            With the expansion unit, axes No. '0' to '7' can be connected.            Without the expansion unit, axes No. '0' to '7' are allowed when '#11012 16 axes for 1ch (Connecting 16 axes for 1ch)' is set to '0', axes No. '0' to 'F' when set to '1'.            (Note 3) If this alarm occurs, the alarm "Y03 Message: Drive unit unequipped" will not occur.            (Note 4) This alarm is displayed taking precedence over the alarm "Y08 Too many drive units connected".            (Note 5) The alarm "Y07 Too many axes connected" is displayed taking precedence over this alarm.</p>		
Y12	No commu. with axis drv unit	
<b>Details</b>		
<p>Although the high-speed synchronous tapping option is valid, the connected drive unit doesn't support the option.</p>		
<b>Remedy</b>		
<ul style="list-style-type: none"> <li>♦Replace the drive unit with that supports the option.</li> <li>♦Set "High-speed synchronous tapping disabled axis" parameter as disabled for the axis to which you don't use the high-speed synchronous tapping.</li> </ul>		
Y13	No commu. with sp drv unit	
<b>Details</b>		
<p>Although the high-speed synchronous tapping option is valid, the connected drive unit doesn't support the option.</p>		
<b>Remedy</b>		
<ul style="list-style-type: none"> <li>♦Replace the drive unit with that supports the option.</li> <li>♦Set "High-speed synchronous tapping disabled axis" parameter as disabled for the spindle to which you don't use the high-speed synchronous tapping.</li> </ul>		



<b>Y14</b>	<b>Hypoth axis connected to drive</b>		
<b>Details</b>			
A drive unit is connected to a hypothetical axis (an axis for which "#2116 v_axis" (Hypothetical axis) is set to "1").			
<b>Remedy</b>			
<ul style="list-style-type: none"> <li>•Disconnect the drive unit from the hypothetical axis.</li> <li>•Correct the settings of "#1021 mcp_no" (Drive unit I/F channel No. (servo)) and the rotary switch on the drive unit.</li> </ul>			
<b>Y15</b>	<b>RIO connection error</b>	0001	(Error channel)
<b>Details</b>			
RIO station number is too large Although a non-RIO2.0 unit is connected, 9 or a greater number is set as a station No.			
<b>Remedy</b>			
<ul style="list-style-type: none"> <li>•If a non-RIO2.0 unit is connected, set the station No. to be 8 or smaller.</li> <li>•If you use 9 or a greater station No., do not connect a non-RIO2.0 unit.</li> </ul>			
<b>Y15</b>	<b>RIO connection error</b>	0002	(Error channel)
<b>Details</b>			
RIO3 connection error A non-RIO2.0 unit is connected to RIO3.			
<b>Remedy</b>			
<ul style="list-style-type: none"> <li>•Connect a RIO2.0-compatible or RIO2.0-dedicated unit.</li> </ul>			
<b>Y15</b>	<b>RIO connection error</b>	0003	(Error channel)
<b>Details</b>			
RIO communication processing time exceeded (PC medium speed) Due to too short DI/DO refresh cycle, the control may not refresh all the DI/DOs connected to one RIO channel at a time.			
<b>Remedy</b>			
<ul style="list-style-type: none"> <li>•Correct the setting of "#1334 DI/DO refresh cycl(DI/DO refresh cycle)".</li> <li>•Connect the remote IO units to RIO1, RIO2 and RIO3 dispersedly to reduce the number of RIO stations connected per RIO channel.</li> </ul>			
<b>Y15</b>	<b>RIO connection error</b>	0004	(Error channel)
<b>Details</b>			
RIO communication processing time exceeded (PC high speed) Due to too short DI/DO refresh cycle, the control may not refresh all the DI/DOs connected to one RIO channel at a time.			
<b>Remedy</b>			
<ul style="list-style-type: none"> <li>•Connect the remote IO units to RIO1, RIO2 and RIO3 dispersedly to reduce the number of RIO stations (which perform high-speed input/output) per RIO channel.</li> </ul>			
<b>Y20</b>	<b>Parameter compare error</b>	0001	(Axis name)
<b>Details</b>			
The speed monitoring parameter in the NC does not correspond to the parameter transmitted to the drive unit. The name of the axis with an error is displayed.			
<b>Remedy</b>			
The NC or the servo drive unit may be damaged. Contact the service center.			
<b>Y20</b>	<b>Sfty obsrvation: Cmd spd err</b>	0002	(Axis name)
<b>Details</b>			
The speed exceeding the speed set with the parameter was commanded during the speed monitoring mode. The name of the axis with an error is displayed.			
<b>Remedy</b>			
Check the speed monitoring parameter and the sequence program. Restart the NC.			

<b>Y20</b>	<b>Sfty obsrvation: FB pos err</b>	0003	(Axis name)
<b>Details</b>			
The commanded position, transmitted to the servo drive unit from NC, is totally different from the feedback position received from the servo drive unit during the speed monitoring mode. The name of the axis with an error is displayed.			
<b>Remedy</b>			
The NC or the servo drive unit may be damaged. Contact the service center.			
<b>Y20</b>	<b>Sfty obsrvation: FB speed err</b>	0004	(Axis name)
<b>Details</b>			
Actual rotation speed of the motor is exceeding the speed that has been set with speed monitoring parameter during the speed monitoring mode. The name of the axis with an error is displayed.			
<b>Remedy</b>			
Correct the speed observation parameter and the sequence program. Restart the NC.			
<b>Y20</b>	<b>Door signal: Input mismatch</b>	0005	Door No.
<b>Details</b>			
Door state signals on the NC side and the drive side do not match. It may be caused by the followings:			
<ul style="list-style-type: none"> <li>♦Cable disconnection</li> <li>♦Damaged door switch</li> <li>♦Damaged NC or servo drive unit</li> </ul>			
<b>Remedy</b>			
Check the cable. Check the door switch. Restart the NC.			
<b>Y20</b>	<b>No speed observation mode in door open</b>	0006	Door No.
<b>Details</b>			
The door open state was detected when the speed monitoring mode was invalid. The causes may be same as the ones for 0005 (Door signal: Input mismatch). Also the sequence program may not be correct.			
<b>Remedy</b>			
Correct the sequence program. Restart the NC.			
<b>Y20</b>	<b>Speed obsv: Para incompatible</b>	0007	(Axis name)
<b>Details</b>			
Two speed monitoring parameters are not matched at the rising edge of the "speed monitor mode" signal. The name of the axis with an error is displayed.			
<b>Remedy</b>			
Correct the relevant parameters so that the two speed monitoring parameters match. Restart the NC.			

Y20	Contactor welding detected	0008	Contactor info
	<p><b>Details</b></p> <p>Contactor welding was detected. The alarm indicates the parameter to which the weld detection device of the error contactor is assigned with the bit.</p> <p>bit0: #1330 MC_dp1 bit1: #1331 MC_dp2 bit2: #1339 MC_dp3 bit3: #1340 MC_dp4</p> <p><b>Remedy</b></p> <ul style="list-style-type: none"> <li>•Make sure that the contactor's auxiliary b contact signal is output correctly to the contactor weld detection device.</li> <li>If welding, replace the contactor.</li> <li>•Check the setting of the contactor weld detection device parameter.</li> </ul>		
Y20	No spec: Safety observation	0009	
	<p><b>Details</b></p> <p>"#2313 SV113 SSF8/bitF (ssc SLS (Safely Limited Speed) function)" and "#13229 SP229 SFNC9/bitF (ssc SLS (Safely Limited Speed) function)" are set for a system with no safety observation option.</p> <p><b>Remedy</b></p> <p>Disable "#2313 SV113 SSF8/bitF (ssc SLS (Safely Limited Speed) function)" and "#13229 SP229 SFNC9/bitF (ssc SLS (Safely Limited Speed) function)". Then, restart the NC.</p>		
Y20	SDIO connector input volt err	0010	
	<p><b>Details</b></p> <p>24VDC power is not supplied to SDIO connector correctly. (SDIO 4A pin supply voltage was dropped to 16V or less, or 1ms or more instant power interrupt was detected.) In this case, "Pw sply:Inst pw interpt(DC24V)" alarm occurs because the contactor control output signal cannot be controlled. This state remains until restarting the NC even if the cause of the alarm has been removed.</p> <p><b>Remedy</b></p> <p>Check the wiring. Supply 24VDC power to the SDIO connector. Restart the NC.</p>		
Y20	Device setting illegal	0011	Contactor info
	<p><b>Details</b></p> <p>Setting of the contactor shutoff output device parameter is incorrect. The alarm indicates the parameter of the incorrect setting with the bit.</p> <p>bit0: #1353 MC_ct1</p> <p><b>Remedy</b></p> <ul style="list-style-type: none"> <li>•Check the setting of the contactor shutoff output device parameter.</li> </ul>		

<b>Y20</b>	<b>Contactor operation abnormal</b>	0012	Contactor info
<b>Details</b>			
Contactor does not operate as commanded by the NC.			
The alarm indicates the parameter to which the weld detection device of the error contactor is assigned with the bit.			
bit0: #1330 MC_dp1			
bit1: #1331 MC_dp2			
bit2: #1339 MC_dp3			
bit3: #1340 MC_dp4			
<b>Remedy</b>			
•Check the settings of the following parameters.			
#1330 MC_dp1			
#1331 MC_dp2			
#1339 MC_dp3			
#1340 MC_dp4			
#1353 MC_ct1			
#1357 mchkt1			
•Check the wiring for contactor shutoff.			
•Check for contactor's welding.			
<b>Y20</b>	<b>STO function operation illegal</b>	0013	
<b>Details</b>			
The drive unit's STO function has failed to work properly.			
<b>Remedy</b>			
If this alarm has occurred alone, a drive unit failure can be suspected.			
If other alarms have been generated at the same time, it is also possible that there is communication problem.			
Check the optical cable wiring.			
<b>Y20</b>	<b>STO function illegal at pwr ON</b>	0014	
<b>Details</b>			
The motor power has not been shut down with the STO function when the NC power was turned ON.			
<b>Remedy</b>			
If this alarm has occurred alone, a drive unit failure can be suspected.			
If other alarms have been generated at the same time, it is also possible that there is communication problem.			
Check the optical cable wiring.			
<b>Y20</b>	<b>Dual signal: parameter setting error</b>	0027	
<b>Details</b>			
A setting of #2118 SscDrSel, #3071 SscDrSelSp, #2180 S_DIN, or #3140 S_DINSp is not correct.			
<b>Remedy</b>			
- Correct the parameter setting.			
<b>Y20</b>	<b>Safety observation: parameter memory error</b>	0031	(Parameter No.)
<b>Details</b>			
The following parameters are not consistent with the check data.			
#2180 S_DIN, #3140 S_DINSp			
<b>Remedy</b>			
•Correct the parameter setting.			
•Restore the backup data, as the parameter or check data may be corrupted.			
<b>Y21</b>	<b>Speed obsv signal: Speed over</b>	0001	(Axis name)
<b>Details</b>			
The speed exceeds the safety speed limit when the "speed monitor mode" signal is ON.			
The name of the axis with an error is displayed.			
<b>Remedy</b>			
Decelerate the speed to reset the warning and start the speed monitor.			

<b>Y40</b>	<b>Machine group-based stop</b>	
	<b>Details</b>	
	A machine group-based alarm stop has occurred, or the machine group-based PLC interlock signal has been input.	
	<b>Remedy</b>	
	•Remove the cause of the stop by alarm.Turn OFF the machine group-based PLC interlock signal.	
<b>Y51</b>	<b>Parameter G0tL illegal</b>	0001
	<b>Details</b>	
	The time constant has not been set or exceeded the setting range.	
	<b>Remedy</b>	
	Correct "#2004 G0tL (G0 time constant (linear))".	
<b>Y51</b>	<b>Parameter G1tL illegal</b>	0002
	<b>Details</b>	
	The time constant has not been set or exceeded the setting range.	
	<b>Remedy</b>	
	Correct "#2007 G1tL (G1 time constant (linear))".	
<b>Y51</b>	<b>Parameter G0t1 illegal</b>	0003
	<b>Details</b>	
	The time constant has not been set or exceeded the setting range.	
	<b>Remedy</b>	
	Correct "#2005 G0t1 (G0 time constant (primary delay) / Second-step time constant for soft acceleration/deceleration)".	
<b>Y51</b>	<b>Parameter G1t1 illegal</b>	0004
	<b>Details</b>	
	The time constant has not been set or exceeded the setting range.	
	<b>Remedy</b>	
	Correct "#2008 G1t1 (G1 time constant (primary delay)/Second-step time constant for soft acceleration/deceleration)".	
<b>Y51</b>	<b>Parameter grid space illegal</b>	0009
	<b>Details</b>	
	The grid space is illegal.	
	<b>Remedy</b>	
	Correct "#2029 grspc(Grid interval)".	
<b>Y51</b>	<b>Parameter stapt1-4 illegal</b>	0012
	<b>Details</b>	
	The time constant has not been set or exceeded the setting range.	
	<b>Remedy</b>	
	Correct the parameters from "#3017 stapt1(Tap time constant (Gear: 00))" to "#3020 stapt4(Tap time constant (Gear: 11))".	
<b>Y51</b>	<b>Slave axis No. illegal</b>	0014
	<b>Details</b>	
	In the axis synchronization, parameter settings for slave axis have been attempted in different part system from that of master axis.	
	<b>Remedy</b>	
	Correct the "#1068 slavno (Slave axis number)" setting.	

<b>Y51</b>	<b>Parameter skip_tL illegal</b>	0015
<b>Details</b>		
The time constant has exceeded the setting range.		
<b>Remedy</b>		
Correct "#2102 skip_tL (Skip time constant linear)".		
<b>Y51</b>	<b>Parameter skip_t1 illegal</b>	0016
<b>Details</b>		
The time constant has exceeded the setting range.		
<b>Remedy</b>		
Correct "#2103 skip_t1 (Skip time constant primary delay / Second-step time constant for soft acceleration/deceleration)".		
<b>Y51</b>	<b>Parameter G0bdcc illegal</b>	0017
<b>Details</b>		
"#1205 G0bdcc (Acceleration and deceleration before G0 interpolation)" for the 2nd part system is set to acceleration/deceleration before G0 interpolation.		
<b>Remedy</b>		
Correct "#1205 G0bdcc (Acceleration and deceleration before G0 interpolation)".		
<b>Y51</b>	<b>OMR-II parameter error</b>	0018
<b>Details</b>		
An illegal setting was found in the OMR-II-related parameters. OMR-II has been disabled.		
<b>Remedy</b>		
Correct the related parameter settings.		
<b>Y51</b>	<b>PLC indexing stroke length err</b>	0019
<b>Details</b>		
"#12804 aux_tleng (Linear axis stroke length)" has not been set or exceeded the setting range while the linear axis equal indexing is enabled for the PLC indexing axis.		
<b>Remedy</b>		
Correct "#12804 aux_tleng (Linear axis stroke length)".		
<b>Y51</b>	<b>Hi-acc time const unextendable</b>	0020
<b>Details</b>		
High-accuracy acceleration/deceleration time constant extension option is unavailable.		
<b>Remedy</b>		
<ul style="list-style-type: none"> <li>♦Adjust the setting of "#1207 G1btL" to be within the range of when the high-accuracy control time constant extension option is OFF.</li> <li>♦High-accuracy acceleration/deceleration time constant extension option is unavailable for a system configured with multiple part systems. Change the system to be made up of a single part system, or set the said option to OFF.</li> </ul>		
<b>Y51</b>	<b>Superimpos linear G0 error</b>	0022
<b>Details</b>		
The time constant has not been set or exceeded the setting range.		
<b>Remedy</b>		
Check "#2092 pIG0tL G0 time constant for superimposition control (linear)".		
<b>Y51</b>	<b>Superimpos linear G1 error</b>	0023
<b>Details</b>		
The time constant has not been set or exceeded the setting range.		
<b>Remedy</b>		
Check "#2094 pIG1tL G1 time constant for superimposition control (linear)".		

<b>Y51</b>	<b>Primary delay G0time const err</b>	0028
<b>Details</b>		
The time constant has not been set or the set time constant is out of the specified range.		
<b>Remedy</b>		
Correct "#2093 plG0t1 G0 time constant for superimposition (primary delay)/2nd step of soft acceleration/deceleration".		
<b>Y51</b>	<b>Primary delay G1time const err</b>	0029
<b>Details</b>		
The time constant has not been set or the set time constant is out of the specified range.		
<b>Remedy</b>		
Correct "#2095 plG1t1 G1 time constant for superimposition (primary delay)/2nd step of soft acceleration/deceleration".		
<b>Y51</b>	<b>Jerk filter time constant err</b>	0030
<b>Details</b>		
Setting of "#12051 Jerk_filtG1" is greater than that of "#1568 SfiltG1". Or setting of "#12052 Jerk_filtG0" is greater than that of "#1569 SfiltG0".		
<b>Remedy</b>		
Change the setting of "#12051 Jerk_filtG1" to be smaller than "#1568 SfiltG1". Or change the setting of "#12052 Jerk_filtG0" to be smaller than "#1569 SfiltG0".		
<b>Y51</b>	<b>Unable to alloc. hi-acc buffer</b>	0031
<b>Details</b>		
The high-accuracy acceleration/deceleration buffer has failed to be allocated.		
<b>Remedy</b>		
The software or hardware may be damaged. Contact the service center.		
<b>Y51</b>	<b>Too many hi-speed/accu systems</b>	0032
<b>Details</b>		
The parameter "#8040 High-speed high-accuracy control-enabled part system" is set to 1 for three or more part systems.		
<b>Remedy</b>		
Set the parameter "#8040 High-speed high-accuracy control-enabled part system" to 1 for up to two part systems.		
<b>Y51</b>	<b>Parameter G0tL_2 illegal</b>	0033
<b>Details</b>		
The time constant is out of the specified range.		
<b>Remedy</b>		
Correct "#2598 G0tL_2 (G0 time constant 2 (linear))".		
<b>Y51</b>	<b>Parameter G0t1_2 illegal</b>	0034
<b>Details</b>		
The time constant is out of the specified range.		
<b>Remedy</b>		
Correct "#2599 G0t1_2 (G0 time constant 2 (primary delay)/Second-step time constant for soft acceleration/deceleration)".		
<b>Y51</b>	<b>3ax line accel G0time const er</b>	0035
<b>Details</b>		
The time constant has not been set or the set time constant is out of the specified range.		
<b>Remedy</b>		
Correct "#2622 pl3G0tL G0 time constant (linear) for 3-axis serial superimposition control".		

<b>Y51</b>	<b>3ax line accel G1time const er</b>	0036
<b>Details</b>		
The time constant has not been set or the set time constant is out of the specified range.		
<b>Remedy</b>		
Correct "#2624 pl3G1tL G1 time constant (linear) for 3-axis serial superimposition control".		
<b>Y51</b>	<b>3ax prim delay G0time const er</b>	0037
<b>Details</b>		
The time constant has not been set or the set time constant is out of the specified range.		
<b>Remedy</b>		
Correct "#2623 pl3G0t1 G0 time constant (primary delay) for 3-axis serial superimposition control/2nd step of soft acceleration/deceleration".		
<b>Y51</b>	<b>3ax prim delay G1time const er</b>	0038
<b>Details</b>		
The time constant has not been set or the set time constant is out of the specified range.		
<b>Remedy</b>		
Correct "#2625 pl3G1t1 G1 time constant (primary delay) for 3-axis serial superimposition control/2nd step of soft acceleration/deceleration".		
<b>Y51</b>	<b>Machine group No. discrepancy</b>	0039
<b>Details</b>		
The machine group Nos. that are used for the machine groupwise alarm stop function are different among the axes related to inclined axis control and synchronous control.		
<b>Remedy</b>		
Give an identical machine group No. to all the axes related to inclined axis control and synchronous control.		
<b>Y51</b>	<b>M-group alarm stop disabled</b>	0040
<b>Details</b>		
The machine group-based alarm stop function has been disabled, because both the machine group-based alarm stop and collision detection functions were enabled.		
<b>Remedy</b>		
♦Disable the collision detection function if you wish to use the machine group-based alarm stop function.		
<b>Y51</b>	<b>Basic axes I, J, K error</b>	0045
<b>Details</b>		
The 1st letter of name extension axis for 2-letter axis (#1013 axname) is specified to the basic axes I, J, and K (parameter #1026 to #1028).		
<b>Remedy</b>		
♦Set the letter other than the 1st letter of name extension axis for 2-letter axis (#1013 axname) to the basic axes I, J and K (parameter #1026 to #1028).		
<b>Y51</b>	<b>Values of PC1/PC2 too large</b>	0101
<b>Details</b>		
The PC1 and PC2 settings for the rotary axis are too large.		
<b>Remedy</b>		
Correct "#2201 SV001 PC1 (Motor side gear ratio)" and "#2202 SV002 PC2 (Machine side gear ratio)".		
<b>Y51</b>	<b>ABS/INC same axis name</b>	0104
<b>Details</b>		
In the absolute/incremental command method using the axis address (L system and when "#1076 AbsInc" = 1), the axis that the same axis address is set in "#1013 axname" and "#1014 incax" exists.		
<b>Remedy</b>		
Correct the settings so that the same axis address is not set in "#1013 axname" and "#1014 incax".		



<b>Y51</b>	<b>Axis name initial setting err</b>	0105
<b>Details</b>		
The axis address that is out of the setting range (other than X, Y, Z, U, V, W, A, B, C, H) is set in "#1013 ax-name" or "#1014 incax".		
<b>Remedy</b>		
Set the axis address within the setting range to "#1013 axname" and "#1014 incax".		
<b>Y51</b>	<b>Parameter error</b>	0201
<b>Details</b>		
Hypothetical axis control parameter setting is incorrect.		
<b>Remedy</b>		
Correct the following parameters:		
<ul style="list-style-type: none"> <li>♦"#1017 rot" (Rotational axis)</li> <li>♦"#2116 v_axis" (Hypothetical axis)</li> <li>♦"#2117 V_axno" (Hypothetical axis No.)</li> <li>♦"#12015 v_dist" (Hypothetical axis tool length)</li> </ul>		
<b>Y90</b>	<b>No spindle signal</b>	0001-0007
<b>Details</b>		
There is an error in the spindle encoder signal. The data transmission to the drive unit is stopped when this error occurs.		
<b>Remedy</b>		
Check the spindle encoder's feedback cable and the encoder.		

## **System Alarms (Z)**

<b>Z02</b>	<b>System error</b>	
<b>Details</b>		
The operation result is illegal.		
<b>Remedy</b>		
•Contact the service center.		
<b>Z11</b>	<b>CC-L IE F communication error</b>	n1 n2
<b>Details</b>		
A communication error has occurred in the communication that uses a CC-Link IE field network unit.		
n1: Indicates the No. of slot to which the expansion unit with the communication error or diagnostic alarm is mounted (in hexadecimal format).		
n2: Indicates the alarm No. of the slot where the communication error or diagnostic alarm is occurring (in hexadecimal format).		
Refer to the list of messages in specification manual.		
<b>Z13</b>	<b>CC-L IE F parameter error</b>	(Parameter No.)
<b>Details</b>		
Parameter setting of #[Parameter No.] is incorrect.		
Refer to the list of messages in specification manual.		
<b>Remedy</b>		
Correct the setting.		
<b>Z14</b>	<b>CC-Link IE F H/W test status</b>	n1 n2
<b>Details</b>		
H/W test is completed for the CC-Link IE field network unit.		
Check the test result.		
n1: Indicates the H/W test result of slot 1 (in hexadecimal format).		
n2: Indicates the H/W test result of slot 2 (in hexadecimal format).		
0: H/W test is normally completed or not performed		
2: External self-loopback test is completed with connection error		
3: External self-loopback test is completed with communication error		
FFFF: H/W test is underway		
<b>Remedy</b>		
Take the following measures according to the test result.		
0: Check the communication mode.		
If the mode is H/W test, switch it to online, and turn OFF and ON the NC power.		
If a mode other than H/W test is active, check the result of the other slot and take the measures.		
2: Make sure the connection of Ethernet cable, or exchange the cable. And then perform the test again.		
If the error occurs again, exchange the H/W.		
3: Exchange the Ethernet cable, and perform the test again.		
If the error occurs again, exchange the H/W.		
FFFF: Turn OFF and ON the NC power.		
If the result is unchanged, exchange the H/W.		

<b>Z18</b>	<b>Network expansion card error</b>	n1 n2
<b>Details</b>		
An abnormality has occurred on the field network communication expansion unit.		
n1: Error slot No.		
n2: Error No.		
<b>Remedy</b>		
0 99:		
Two Fieldbus communication expansion units which cannot be used simultaneously are mounted simultaneously. Remove either of Fieldbus communication expansion unit.		
Other than 0 99:		
A failure on the hardware can be speculated. Replace the field network communication expansion unit.		
<b>Z21</b>	<b>PROFIBUS parameter error</b>	(Parameter No.)
<b>Details</b>		
The parameter #[Parameter #] is incorrect.		
<b>Remedy</b>		
Correct the setting.		
<b>Z23</b>	<b>AXIS EX-ADR. ERROR</b>	
<b>Details</b>		
The axis not extending the address (1 character axis) exists at the back of the axis extending the address (2 character axis) in the same system.		
<b>Remedy</b>		
♦Improve the axis composition. The axis not extending the address can not exist at the back of the axis extending the address in the same system.		
<b>Z25</b>	<b>Unable to start safe spd clamp</b>	
<b>Details</b>		
The SLS observation request signal has been turned OFF in any of the following machining modes: Thread cutting, synchronous tapping, cross machining, superimposition control, tool center point control or SSS control		
<b>Remedy</b>		
♦Perform the operation with the SLS observation request signal ON.		
♦Perform the operation with the door closed.		
<b>Z26</b>	<b>NC unit replacement illegal</b>	
<b>Details</b>		
NC unit is replaced to the FCU8-MU541, FCU8-MA541, FCU8-MU501, or FCU8-MU502.		
<b>Remedy</b>		
♦Contact to your service center.		
♦Press the reset to cancel the warning and continue the operations.		
<b>Z27</b>	<b>FunctlSafetyExpnsCard MountErr</b>	
<b>Details</b>		
A functional safety expansion card is mounted to the NC unit (FCU8-MU501 or FCU8-MU50).		
<b>Remedy</b>		
♦Contact to your service center.		
♦Press the reset to cancel the warning and continue the operations.		
<b>Z28</b>	<b>EtherNet/IP parameter error</b>	(Parameter No.)
<b>Details</b>		
Parameter setting of #[Parameter No.] is incorrect.		
Refer to the list of messages in "EtherNet/IP specification manual".		
<b>Remedy</b>		
Correct the setting.		

<b>Z29</b>	<b>EtherNet/IP communication err</b>	n1 n2 n3 n4
<b>Details</b>		
A communication error has occurred in the communication that uses an EtherNet/IP expansion unit.		
[n1: Output the device Number (in hexadecimal format)]		
FF: Simultaneously mounting two EtherNet/IP expansion units error		
Other than FF: Device No. of the connected device		
[n2: Output the position No. (in hexadecimal format)]		
FF: Simultaneously mounting two EtherNet/IP expansion units error		
Other than FF: Device No. of the connected device		
[n3: Output the device communication status (IN) (in hexadecimal format)]		
[n4: Output the device communication status (OUT) (in hexadecimal format)]		
For details, refer to "EtherNet/IP Specifications manual".		
<b>Z31</b>	<b>Socket open error(socket)</b>	0001
<b>Details</b>		
Socket open error (socket)		
<b>Remedy</b>		
Set the parameter then turn the power OFF and ON again.		
<b>Z31</b>	<b>Socket bind error(bind)</b>	0002
<b>Details</b>		
Socket bind error (bind)		
<b>Remedy</b>		
Set the parameter then turn the power OFF and ON again.		
<b>Z31</b>	<b>Connection wait queue error(listen)</b>	0003
<b>Details</b>		
Connection wait queue error (listen)		
<b>Remedy</b>		
Set the parameter then turn the power OFF and ON again.		
<b>Z31</b>	<b>Connection request error(accept)</b>	0004
<b>Details</b>		
Connection request error (accept)		
<b>Z31</b>	<b>Data rcv error(socket error)</b>	0005
<b>Details</b>		
Data receive error (socket error)		
<b>Z31</b>	<b>Data rcv error(data error)</b>	0006
<b>Details</b>		
Data receive error (data error)		
<b>Z31</b>	<b>Data send error(socket error)</b>	0007
<b>Details</b>		
Data send error (socket error)		
<b>Z31</b>	<b>Data send error(data error)</b>	0008
<b>Details</b>		
Data send error (data error)		
<b>Z31</b>	<b>Socket close error(close)</b>	000A
<b>Details</b>		
Socket close error (close)		
<b>Remedy</b>		
Set the parameter then turn the power OFF and ON again.		

<b>Z34</b>	<b>DeviceNet error</b>	
<b>Details</b>		
Any of the following errors has occurred in the DeviceNet unit.		
<ul style="list-style-type: none"> <li>♦Master function error (X03 is ON)</li> <li>♦Slave function error (X08 is ON)</li> <li>♦Message communication error (X05 is ON)</li> </ul>		
If the errors have occurred in more than one unit, the error No. of the unit with the smallest slot No. is displayed.		
If the master function, slave function and message communication errors have occurred at the same time, the error is displayed in the following priority order.		
<ol style="list-style-type: none"> <li>1. Master function error</li> <li>2. Slave function error</li> <li>3. Message communication error</li> </ol>		
<b>Remedy</b>		
♦Select the [Ext. PLC link control] menu on the maintenance screen to open the unit confirmation screen, and check the unit in error and details to cancel the error.		
<b>Z35</b>	<b>Direct Socket connection error</b>	0001
<b>Details</b>		
<ul style="list-style-type: none"> <li>- Connection has failed.</li> <li>- Five or more clients attempted a connection.</li> </ul>		
<b>Remedy</b>		
♦Check the connection of the network cables, and check for broken wires and a failure of the network connection devices such as hub.		
♦When using the Direct Socket communication I/F, connect up to four clients.		
<b>Z35</b>	<b>Direct Socket receive error</b>	0002
<b>Details</b>		
- Receiving data from a client has failed.		
<b>Remedy</b>		
♦Check the connection of the network cables, and check for broken wires and a failure of the network connection devices such as hub.		
<b>Z35</b>	<b>Direct Socket send error</b>	0003
<b>Details</b>		
- Sending data to a client has failed.		
<b>Remedy</b>		
♦Check the connection of the network cables, and check for broken wires and a failure of the network connection devices such as hub.		
<b>Z35</b>	<b>Direct Socket timeout error</b>	0004
<b>Details</b>		
There was no response from client computers, and a timeout error occurred.		
<b>Remedy</b>		
♦Check the connection of the network cables, and check for broken wires and a failure of the network connection devices such as hub.		
<b>Z35</b>	<b>Direct Socket comm OFF</b>	0005
<b>Details</b>		
The direct Socket communication I/F is OFF.		
<b>Remedy</b>		
♦Check the parameter "#11051 Direct Socket ON".		

<b>Z36</b>	<b>EcoMonitorLight comm. error</b>
<b>Details</b>	
An error has occurred in the communication with EcoMonitorLight.	
<b>Remedy</b>	
Make sure that the CNC has the same communication settings (station No., baud rate, parity and stop bit) as the EcoMonitorLight in error.	
Make sure that there are no problems with the serial cable connected to the EcoMonitorLight.	
Make sure to place the serial cable in a low-noise environment.	
<b>Z37</b>	<b>EcoMonitorLight qty discrepant</b>
<b>Details</b>	
The number of EcoMonitorLight units connected is inconsistent with the setting of the parameter #11061.	
<b>Remedy</b>	
Make sure that the value set in the parameter #11061 coincides with the number of EcoMonitorLight units connected to the CNC.	
Also make sure all the EcoMonitorLight units connected are powered ON and the station No. is not duplicated.	
<b>Z38</b>	<b>Insulation deterioration wrn</b>
<b>Details</b>	
The motor insulation has been deteriorated.	
0001: Motor insulation deterioration: Caution	
0002: Motor insulation deterioration: Replacement required	
0003: Motor insulation deterioration: Relay welding detected	
<b>Remedy</b>	
0001: The insulation resistance value of the motor has dropped. Contact the service center.	
0002: The insulation resistance value of the motor is less than or equal to the reference value. Contact the service center. When measuring the insulation resistance of the motor and the measured resistance value is less than or equal to the specified value, the motor may be damaged.	
0003: The drive unit may be damaged. Contact the service center.	
<b>Z39</b>	<b>E-mail send error</b>
<b>Details</b>	
E-mail sending with the email notification to operator function failed.	
<b>Remedy</b>	
<ul style="list-style-type: none"> <li>♦Check the e-mail environment setting.</li> <li>♦Check the registered e-mail address.</li> <li>♦Set "0" in "#8134 E-mail send disabled".</li> </ul>	
<b>Z43</b>	<b>Parameter input error</b>
<b>Details</b>	
Writing the parameter file failed.	
When the parameter number is not "0000": Range exceeded	
<ul style="list-style-type: none"> <li>♦The parameter value is incorrect.</li> <li>♦The part system number, axis number, spindle number or data number is incorrect.</li> </ul>	
When the parameter number is "0000": Format error	
<ul style="list-style-type: none"> <li>♦The format is incorrect.</li> </ul>	
(Note) The screen shows the parameter in which the input error was first detected.	
<b>Remedy</b>	
<ul style="list-style-type: none"> <li>♦Correct the parameter file and import it again.</li> <li>♦Switch the "Parameter input error cancel" signal (Y1C87) from OFF to ON.</li> </ul>	
(Note) When the alarm indication for a certain parameter is removed with the signal while the input error is occurring for more than one parameter, the alarm will not be indicated again for the other parameter.	

<b>Z49</b>	<b>RIO watchdog error</b>	0001
<b>Details</b>		
An error has occurred in the remote I/O unit.		
<b>Remedy</b>		
<ul style="list-style-type: none"> <li>◆ Turn the power ON again.</li> <li>◆ If this error remains active after the power ON, replace the remote I/O unit.</li> </ul>		
<b>Z51</b>	<b>E2PROM error</b>	001x
<b>Details</b>		
[Type]		
Z51 E2PROM error 0011: Read error		
Z51 E2PROM error 0012: Write error		
<b>Remedy</b>		
<ul style="list-style-type: none"> <li>◆ If the same alarm is output by the same operation, the cause is an H/W fault. Contact the Service Center.</li> </ul>		
<b>Z52</b>	<b>Battery fault</b>	000x
<b>Details</b>		
The voltage of the battery in the NC control unit has dropped. (The battery used to save the internal data.)		
0001: Battery warning		
0002: Battery detecting circuit error		
0003: Battery alarm		
(Note) The display of "Z52 battery fault 0001" can be removed by resetting. However, the warning state will not be cleared until the battery is replaced.		
<b>Remedy</b>		
<ul style="list-style-type: none"> <li>◆ Replace the battery of the NC control unit.</li> <li>◆ Check for any disconnection of the battery cable.</li> <li>◆ After fixing the battery's fault, check the machining program.</li> </ul>		
<b>Z53</b>	<b>CNC overheat</b>	
<b>Details</b>		
The controller or operation board temperature has risen above the designated value.		
(Note) Temperature warning		
When an overheat alarm is detected, the alarm is displayed and the overheat signal is output simultaneously. Automatic operation will be continued, while restarting after resetting or stopping with M02/M30 is not possible. (Restarting after block stop or feed hold is possible.)		
The alarm will be cleared and the overheat signal will turn OFF when the temperature drops below the specified temperature.		
Z53 CNC overheat 000x		
[000x]		
(For all models)		
0001: The temperature in the control unit is high.		
The ambient temperature must be lowered immediately when a "Z53 CNC overheat" alarm occurs. However, if the machining needs to be continued, set "#6449/bit7 Control unit temperature alarm ON" to "0". Then the alarm will be invalidated.		
<b>Remedy</b>		
<ul style="list-style-type: none"> <li>◆ Cooling measures are required.</li> <li>◆ Turn OFF the controller power, or lower the temperature with a cooler, etc.</li> </ul>		



<b>Z55</b>	<b>RIO communication stop</b>
<b>Details</b>	
<p>An error occurs in the communication between the control unit and remote I/O unit.            Disconnection of a cable            Fault in remote I/O unit            Fault of power supply to remote I/O unit</p> <p>The communication interrupted station is displayed in hexadecimal for each RIO channel when an error occurs in the communication between the control unit and remote I/O unit.</p> <p>When the control displays a communication stop station, it divides the RIO channel stations (up to 64 stations) into groups of 8 stations. If any of the 8 stations has the communication stop error, the number is displayed with the alarm.</p> <p>Z55 RIO communication stop   __ __ __ __   __ __ __ __              (a) (b) (c) (d)   (e) (f) (g) (h)</p> <p>(a)(b): RIO1            (c)(d): RIO2            (e)(f): RIO3            (g)(h): "00" fixed</p> <p>(a)(b), (c)(d), and (e)(f) indicate the following stations in hexadecimal.</p> <p>bit0: 1st to 8th stations            bit1: 9th to 16th stations            bit2: 17th to 24th stations            bit3: 25th to 32nd stations            bit4: 33rd to 40th stations            bit5: 41st to 48th stations            bit6: 49th to 56th stations            bit7: 57th to 64th stations</p> <p>(Example) Stations #1 and #8 of RIO1 and stations #24 and #64 of RIO3 have the communication error.            Z55 RIO communication stop 0100 8400</p> <p>The RIO error status can be monitored through the R registers on the self diagnostic or I/F diagnostic screen.</p>	
<b>Remedy</b>	
<ul style="list-style-type: none"> <li>•Check and replace the cables.</li> <li>•Replace the remote I/O unit.</li> <li>•Check the power supply (existence of supply and voltage).</li> </ul>	
<b>Z57</b>	<b>System warning</b>
<b>Details</b>	
<p>Program memory capacity has been set over the value that can be formatted.            An expansion device/expansion cassette has not mounted after formatting.            The mounted expansion device/expansion cassette is different from the one that was mounted at formatting.</p>	
<b>Remedy</b>	
<p>Check the followings.</p> <ul style="list-style-type: none"> <li>•Program memory capacity</li> <li>•Mounting of an expansion device/expansion cassette</li> <li>•APLC release option</li> </ul>	
<b>Z58</b>	<b>ROM write not completed</b>
<b>Details</b>	
<p>A machine tool builder macro program has not been written to FROM after being registered/ edited/ copied/ condensed/ merged/ the number changed/ deleted.</p>	
<b>Remedy</b>	
<ul style="list-style-type: none"> <li>•Write the machine tool builder macro program to FROM.</li> </ul> <p>The program does not need to be written to FROM unless the editing operations and so on need to be valid after the NC power OFF.</p>	

<b>Z59</b>	<b>Acc/dec time cnst too large</b>	
<b>Details</b>		
Acceleration and deceleration time constants are too large. (This alarm occurs with the stop code (T02 0206).)		
<b>Remedy</b>		
<ul style="list-style-type: none"> <li>♦Set the larger value for "#1206 G1bF(Maximum speed)".</li> <li>♦Set the smaller value for "#1207 G1btL(Time constant)".</li> <li>♦Set the lower feedrate.</li> </ul>		
<b>Z60</b>	<b>Fieldbus communication error</b>	n1 n2 n3 n4
<b>Details</b>		
A communication error has occurred on the Fieldbus communication with FCU8-WN563.		
[n1: denotes the master station status (in the hexadecimal form).]		
00: Offline: In initialization		
40: Stop: I/O communication stopped		
80: Clear: Resetting the output data of each slave by sending zero data		
C0: In operation: In I/O communication		
FF: Two Fieldbus expansion units are mounted.		
[n2: denotes the error condition (in the hexadecimal form).]		
bit0: Control error: Parameter error		
bit1: Auto clear error: Communication with all the slave stations was cut because a communication with one slave station had an error.		
bit2: Non-exchange error: A slave station has communication error.		
bit3: Fatal error: Communication cannot be continued because of severe network failure.		
bit4: Not ready: CNC communication is not ready.		
bit5: Timeout error: Timeout is detected in communication with each station.		
bit6: Not used		
bit7: Not used		
FF: Two Fieldbus expansion units are mounted.		
[n3: denotes the slave station where communication error has occurred(in the hexadecimal form).]		
* FF is indicated when two Fieldbus expansion units are mounted.		
[n4: denotes the error number (in the hexadecimal form).]		
This shows the communication state with slave station where error is occurring. For details, refer to "PROFIBUS-DP Specification manual".		
<b>Z64</b>	<b>Valid term soon to be expired</b>	xx
<b>Details</b>		
The valid term will be expired in less than a week. Remaining valid term is xx days.		
<b>Remedy</b>		
♦Obtain a decryption code from the machine tool builder and input it in the NC, then turn the power ON again.		
<b>Z65</b>	<b>Valid term has been expired</b>	
<b>Details</b>		
The valid term has been expired with no decryption code input.		
<b>Remedy</b>		
♦Obtain a decryption code from the machine tool builder and input it in the NC, then turn the power ON again.		
<b>Z67</b>	<b>CC-Link communication error</b>	
<b>Details</b>		
A communication error occurred during CC-Link communication using CC-Link unit.		
<b>Remedy</b>		
♦Refer to "List of Messages" in CC-Link (Master/Local) Specification manual (BNP-C3072-089).		
<b>Z68</b>	<b>CC-Link unconnected</b>	
<b>Details</b>		
A cable between CC-Link unit and a device is disconnected or broken.		
<b>Remedy</b>		
♦Find the unconnected cable by checking SW0080 to SW0083 and connect it.		

<b>Z69</b>	<b>External link error</b>	<b>2</b>
<b>Details</b>		
A FROM/TO instruction was used while the MELSEC-Q interface expansion module is not installed.		
<b>Remedy</b>		
Install the MELSEC-Q interface expansion module.		
<b>Z69</b>	<b>External link error</b>	<b>3</b>
<b>Details</b>		
A negative value was set for an I/O No. in the FROM/TO instruction.		
<b>Remedy</b>		
Correct the I/O No.		
<b>Z69</b>	<b>External link error</b>	<b>4</b>
<b>Details</b>		
A negative value was set for transfer size in the FROM/TO instruction.		
<b>Remedy</b>		
Correct the transfer size.		
<b>Z69</b>	<b>External link error</b>	<b>5</b>
<b>Details</b>		
The number of FROM/TO instructions within one scan has exceeded 50.		
<b>Remedy</b>		
Correct the user PLC (ladder sequence) so that the number of FROM/TO instructions per scan is 50 or less.		
<b>Z69</b>	<b>External link error</b>	<b>6</b>
<b>Details</b>		
The access to the buffer memory by the FROM/TO instruction has exceeded 12K words per scan.		
<b>Remedy</b>		
Correct the user PLC (ladder sequence) so that the buffer memory access by the FROM/TO instruction won't exceed 12K words per scan. (The total size of FROM/TO is up to 12K words.)		
<b>Z69</b>	<b>External link error</b>	<b>7</b>
<b>Details</b>		
A FROM/TO instruction was used in high-speed processing.		
<b>Remedy</b>		
Delete the FROM/TO instruction from high-speed processing.		
<b>Z69</b>	<b>External link error</b>	<b>8</b>
<b>Details</b>		
The bit device number designated in the FROM/TO instruction is not a multiple of 16.		
<b>Remedy</b>		
Correct the bit device number designated in the FROM/TO instruction to be a multiple of 16.		
<b>Z69</b>	<b>External link error</b>	<b>9</b>
<b>Details</b>		
With a FROM/TO instruction, a value out of the address range (negative value, or 0x8000 or over) was set as the head address of the buffer memory.		
<b>Remedy</b>		
Correct the head address of the buffer memory.		
<b>Z69</b>	<b>External link error</b>	<b>10</b>
<b>Details</b>		
An alarm occurred in the MELSEC module mounted on the extension base.		
<b>Remedy</b>		
Check for any disconnection of the MELSEC module and the cables on the extension base. Then turn the CNC's power ON again.		

<b>Z69</b>	<b>External link error</b>	11
<b>Details</b>		
The I/O No. designated in the FROM/TO instruction is different from the mounted location of the intelligent function module on the extension base (the module's I/O No.).		
<b>Remedy</b>		
Correct the I/O No. Then turn the CNC's power ON again.		
<b>Z82</b>	<b>3D machine interference/No machine model</b>	0001
<b>Details</b>		
Machine model is not registered.		
<b>Remedy</b>		
<ul style="list-style-type: none"> <li>◆Press RESET to cancel the alarm.</li> </ul> Movement can be resumed after the cancellation. However, the 3D machine interference check will become invalid.		
<ul style="list-style-type: none"> <li>◆Inform the machine tool builder if an alarm occurs.</li> </ul>		
<b>Z82</b>	<b>3D machine interference/Machine model illegal</b>	0002
<b>Details</b>		
Machine model is illegal.		
<b>Remedy</b>		
<ul style="list-style-type: none"> <li>◆Press RESET to cancel the alarm.</li> </ul> Movement can be resumed after the cancellation. However, the 3D machine interference check will become invalid.		
<ul style="list-style-type: none"> <li>◆Inform the machine tool builder if an alarm occurs.</li> </ul>		
<b>Z82</b>	<b>3D machine Interference check load excess</b>	0003
<b>Details</b>		
The calculation of the interference check took time and caused a deceleration.		
<b>Remedy</b>		
<ul style="list-style-type: none"> <li>◆Inform the machine tool builder.</li> <li>◆Restart the axis in case of a manual operation.</li> <li>◆In case of an automatic operation, the operation will automatically resume when the processing load of the interference check decreases.</li> </ul>		
<b>Z82</b>	<b>3D machine Interference check error</b>	0004
<b>Details</b>		
The interference check failed.		
<b>Remedy</b>		
<ul style="list-style-type: none"> <li>◆Take a note of the failed status and contact the service center.</li> <li>◆Press RESET to cancel the alarm. Invalidate the 3D machine interference check to continue the operation.</li> </ul>		
<b>Z84</b>	<b>Unable to save all the history</b>	
<b>Details</b>		
The system is unable to store the data due to lack of free space on the internal memory.		
<b>Remedy</b>		
<ul style="list-style-type: none"> <li>◆Ensure sufficient free space on the internal memory.</li> </ul>		
<b>Z85</b>	<b>OP panel I/O not connected</b>	0001
<b>Details</b>		
Failed to recognize the connection between the NC unit and operation panel I/O unit.		
<b>Remedy</b>		
<ul style="list-style-type: none"> <li>◆Make sure an operation panel I/O unit is connected.</li> <li>◆Make sure an operation panel I/O unit is supplied with power.</li> <li>◆Check for disconnection of the cable between the NC unit and operation panel I/O unit.</li> </ul> *If you connect no operation panel I/O unit to the NC unit, set the parameter "#1261 set33/bit1" to "1".		

<b>Z85</b>	<b>No display conn. to panel I/O</b>	0002
<b>Details</b>		
No display unit is connected to the operation panel I/O unit.		
<b>Remedy</b>		
<ul style="list-style-type: none"> <li>•Make sure an operation panel I/O unit for M800W Series is connected.</li> <li>•Make sure the display unit is being powered.</li> <li>•Check for any cable disconnection between operation panel I/O and display units.</li> </ul>		
*If operation panel I/O is not connected to display unit in your system configuration, set the parameter "#1261 set33/bit2" to "0".		
<b>Z85</b>	<b>Power ON sequence error</b>	0003
<b>Details</b>		
No display unit is connected to the operation panel I/O unit.		
<b>Remedy</b>		
<ul style="list-style-type: none"> <li>•Make sure an operation panel I/O unit for M800W Series is connected.</li> <li>•Make sure the operation panel I/O unit is being powered.</li> <li>•Check for any cable disconnection between NC and operation panel I/O units.</li> <li>•Make sure the operation panel I/O and display units are connected.</li> </ul>		
* If operation panel I/O is not connected to display unit in your system configuration, set the parameter "#1261 set33/bit2" to "0".		
* If no operation panel I/O is connected in your system configuration, set the parameter "#1261 set33/bit1" to "1", and "#1261 set33/bit2" to "0".		
<b>Z85</b>	<b>Power OFF sequence error</b>	0004
<b>Details</b>		
Power OFF sequence has not been executed correctly.		
<b>Remedy</b>		
<ul style="list-style-type: none"> <li>•Make sure an operation panel I/O unit for M800W Series is connected.</li> <li>•Make sure the operation panel I/O unit is being powered.</li> <li>•Check for any cable disconnection between NC and operation panel I/O units.</li> <li>•Make sure the operation panel I/O and display units are connected.</li> </ul>		
*If no operation panel I/O is connected in your system configuration, set the parameter "#1261 set33/bit1" to "1", and "#1261 set33/bit2" to "0".		
*If operation panel I/O is not connected to display unit in your system configuration, set the parameter "#1261 set33/bit2" to "0".		
<b>Z85</b>	<b>Display unit shutoff timeout</b>	0005
<b>Details</b>		
Timeout has occurred during wait for the display power shutdown when automatic power OFF is being executed.		
<b>Remedy</b>		
<ul style="list-style-type: none"> <li>•Make sure an operation panel I/O unit for M800W Series is connected.</li> <li>•Make sure the operation panel I/O unit is being powered.</li> <li>•Check for any cable disconnection between NC and operation panel I/O units.</li> <li>•Make sure the operation panel I/O and display units are connected.</li> </ul>		
*If no operation panel I/O is connected in your system configuration, set the parameter "#1261 set33/bit1" to "1", and "#1261 set33/bit2" to "0".		
* If operation panel I/O is not connected to display unit in your system configuration, set the parameter "#1261 set33/bit2" to "0".		
<b>Z86</b>	<b>Overvoltage detection warning</b>	0001
<b>Details</b>		
Overvoltage was detected in hardware voltage.		
<b>Remedy</b>		
<ul style="list-style-type: none"> <li>•If this alarm occurs frequently, check the power supply voltage.</li> </ul>		

---

<b>Z86</b>	<b>Overvoltage detection alarm</b>	0002
------------	------------------------------------	------

---

**Details**  
Overvoltage was detected in hardware voltage.

**Remedy**

- ◆Turn OFF and ON the NC power.
- ◆If this alarm occurs frequently, check the power supply voltage.

---

<b>Z92</b>	<b>Memory ECC error</b>	0004
------------	-------------------------	------

---

**Details**  
Incorrect data has been read out from the internal memory.

**Remedy**

- ◆Contact the service center.



## **Absolute Position Detection System Alarms (Z7\*)**



<b>Z70</b>	<b>Abs posn base set incomplete</b>	0001	(Axis name)
<b>Details</b>			
Zero point initialization is incomplete. Otherwise, the spindle was removed.			
<b>Remedy</b>			
Complete zero point initialization.			
<b>Z70</b>	<b>Absolute position lost</b>	0002	(Axis name)
<b>Details</b>			
The absolute position basic point data saved in the NC has been damaged.			
<b>Remedy</b>			
Set the parameters. If the basic point data is not restored by setting the parameters, perform zero point initialization.			
<b>Z70</b>	<b>Abs posn param changed</b>	0003	(Axis name)
<b>Details</b>			
Any of the parameters for absolute position detection has been changed.			
#1003 iunit			
#1017 rot			
#1018 ccw			
#1040 M_inch			
#2049 type			
#2201 PC1			
#2202 PC2			
#2218 PIT			
#2219 RNG1			
#2220 RNG2			
#2225 MTYP			
<b>Remedy</b>			
Correct the parameter settings. Then turn the power ON again and perform zero point initialization.			
<b>Z70</b>	<b>Abs posn initial set illegal</b>	0004	(Axis name)
<b>Details</b>			
The zero point initialization point is not at the grid position.			
<b>Remedy</b>			
Perform the zero point initialization again.			
<b>Z70</b>	<b>Abs posn param restored</b>	0005	(Axis name)
<b>Details</b>			
The data has been restored by inputting the parameters during the alarm No.0001, 0002, and 0003.			
<b>Remedy</b>			
Turn the power ON again to start the operation.			
<b>Z70</b>	<b>Abs data error</b>	0006	(Axis name)
<b>Details</b>			
The deviation in the position of machine before and after the power ON has exceeded the set value for the parameter "#2051 check".			
This alarm is issued mainly due to one of the following causes:			
•Displacement in the position of machine			
•Encoder failure			
<b>Remedy</b>			
Return the machine to the reference position to see if the machine position is correct.			
If correct, the machine moved physically after the power OFF.			
Resolve the cause of the movement, such as a brake failure and machine imbalance, and then restart the NC.			
If incorrect, the encoder may be at fault.			
Replace the encoder and then perform a zero initialization.			
Investigate the cause of displacement in the servo axis that occurred prior to the power ON.			

<b>Z70</b>	<b>Excess posn devia. at power ON</b>	0007	(Axis name)
<b>Details</b>			
The deviation in the position of machine before and after the power ON has exceeded the set value for the parameter "#2051 check".			
This alarm is issued mainly due to one of the following causes:			
<ul style="list-style-type: none"> <li>◆Displacement in the position of machine</li> <li>◆Encoder failure</li> </ul>			
<b>Remedy</b>			
Make sure to carry out a zero initialization not to lose the absolute position.			
Return the machine to the reference position to see if the machine position is correct.			
If correct, the machine moved physically after the power OFF.			
Perform a zero initialization.			
If incorrect, the encoder may be at fault.			
Replace the encoder and then perform a zero initialization.			
Investigate the cause of displacement in the servo axis that occurred prior to the power ON.			
<b>Z70</b>	<b>Abs posn data lost</b>	0080	(Axis name)
<b>Details</b>			
The absolute position data has been lost. An error of the multi-rotation counter data in the encoder and so on may be the cause. (Liquid penetrates into encoder connector, etc.)			
<b>Remedy</b>			
Replace the encoder and complete zero point initialization.			
<b>Z70</b>	<b>Abs posn error(servo alm 25)</b>	0101	(Axis name)
<b>Details</b>			
The servo alarm No. 25 was displayed and the power was turned ON again.			
<b>Remedy</b>			
Perform zero point initialization again.			
<b>Z70</b>	<b>Abs posn error(servo alm E3)</b>	0106	(Axis name)
<b>Details</b>			
The servo alarm No. E3 was displayed and the power was turned ON again.			
<b>Remedy</b>			
Perform zero point initialization again.			
<b>Z71</b>	<b>AbsEncoder:Backup voltage drop</b>	0001	(Axis name)
<b>Details</b>			
Backup voltage in the absolute encoder dropped.			
<b>Remedy</b>			
Replace the battery, check the cable connections, and check the encoder. Turn the power ON again and perform zero point initialization.			
<b>Z71</b>	<b>AbsEncoder: Commu error</b>	0003	(Axis name)
<b>Details</b>			
Communication with the absolute encoder has been disabled.			
<b>Remedy</b>			
Check and replace the cables, card or encoder. Turn the power ON again and perform zero point initialization.			
<b>Z71</b>	<b>AbsEncoder: Abs data changed</b>	0004	(Axis name)
<b>Details</b>			
Absolute position data has been changed at the absolute position establishment.			
<b>Remedy</b>			
Check and replace the cables, card or encoder. Turn the power ON again and perform zero point initialization.			

<b>Z71</b>	<b>AbsEncoder: Serial data error</b>	0005	(Axis name)
<b>Details</b>			
An error of the serial data was found in the absolute encoder.			
<b>Remedy</b>			
Check and replace the cables, card or encoder. Turn the power ON again and perform zero point initialization.			
<b>Z71</b>	<b>AbsEncoder: Abs/inc posn diff</b>	0006	(Axis name)
<b>Details</b>			
Servo alarm E3 Absolute position counter warning			
<b>Remedy</b>			
Operation is possible until the power is turned OFF.			
<b>Z71</b>	<b>AbsEncoder: Initial commu er</b>	0007	(Axis name)
<b>Details</b>			
Initial communication with the absolute encoder is not possible.			
<b>Remedy</b>			
Check and replace the cables, card or encoder. Turn the power ON again and perform zero point initialization.			
<b>Z72</b>	<b>Message: Position check error</b>		(Axis name)
<b>Details</b>			
An error is detected at the comparison of encoder's absolute position and controller coordinate values in the absolute position detection system.			
<b>Z73</b>	<b>Battery for abs data fault</b>	0001	
<b>Details</b>			
Low backup battery Servo alarm 9F Low battery voltage			
<b>Remedy</b>			
If the battery voltage is low or the cable is damaged, there is no need to initialize the absolute position.			

# Distance-coded Reference Scale Errors (Z8\*)

<b>Z80</b>	<b>Basic position lost</b>	0001
<b>Details</b>		
The basic point data saved in the NC has been damaged.		
<b>Remedy</b>		
♦Set the parameters. If the basic point data is not restored by setting the parameters, perform zero point initialization.		
<b>Z80</b>	<b>Basic position restore</b>	0002
<b>Details</b>		
The basic point data has been restored by setting the parameters.		
<b>Remedy</b>		
♦Turn the power ON again to start the operation.		
<b>Z80</b>	<b>No spec: Distance-coded scale</b>	0003
<b>Details</b>		
The distance-coded reference scale has been set available although this function is out of the specifications.		
<b>Remedy</b>		
♦Check the specifications.		
♦If you do not use this function, correct the encoder type with the servo parameter.		
<b>Z81</b>	<b>R-pos adjustment data lost</b>	0001
<b>Details</b>		
Reference position adjustment value data saved in the CNC has been damaged.		
<b>Remedy</b>		
♦Set the parameter. If the data is not restored by setting the parameter, establish the reference position again.		
<b>Z81</b>	<b>R-pos adjustment data restored</b>	0002
<b>Details</b>		
After the 'Z81 R-pos adjustment data lost 0001', the data has been recovered by setting the parameter.		
<b>Remedy</b>		
♦Establish the reference position to start the operation.		
<b>Z83</b>	<b>NC started during SP rotation</b>	0001
<b>Details</b>		
The NC was started while the spindle was rotating.		
<b>Remedy</b>		
♦ Turn OFF the power once, and make sure that the spindle is stopped before turning ON the power again.		
♦You can select whether or not to stop the spindle forcibly at the occurrence of this alarm by the setting of the base common parameter "#1284 ext20/bit1" (Spindle control selected in response to Z83 (NC started during SP rotation)).		
♦If this alarm occurs frequently, check the power supply voltage.		

## Emergency Stop Alarms (EMG)

<b>EMG</b>	<b>Emergency stop</b>	PLC
	<b>Details</b>	
	The "PLC emergency stop" signal is turned ON during the sequence processing of the user PLC.	
	<b>Remedy</b>	
	•Check the conditions to turn the "Emergency stop" signal ON and remove the cause of the alarm during the sequence processing of the user PLC.	
<b>EMG</b>	<b>Emergency stop</b>	EXIN
	<b>Details</b>	
	The "emergency stop" signal is significant (open).	
	<b>Remedy</b>	
	•Cancel the "emergency stop" signal. •Check for any broken wires.	
<b>EMG</b>	<b>Emergency stop</b>	SRV
	<b>Details</b>	
	An alarm occurred in the servo system causing an emergency stop.	
	<b>Remedy</b>	
	•Investigate and remove the cause of the servo alarm.	
<b>EMG</b>	<b>Emergency stop</b>	STOP
	<b>Details</b>	
	The user PLC (ladder sequence) is not running.	
	<b>Remedy</b>	
	•Check the setting of the control unit rotary switch CS2. Correct it if set to "1". •Check the [RUN/SP] (run/stop) switch on the PLC edit file save screen (onboard function). Turn it OFF if ON.	
<b>EMG</b>	<b>Emergency stop</b>	SPIN
	<b>Details</b>	
	Spindle drive unit is not mounted.	
	<b>Remedy</b>	
	•Cancel the causes of the other emergency stop. •Check the "emergency stop" signal input in the spindle drive unit.	
<b>EMG</b>	<b>Emergency stop</b>	PC_H
	<b>Details</b>	
	Failure in the high-speed PC processing abnormal	
	<b>Remedy</b>	
	•Correct the sequence program. (To stop monitoring the high-speed PC processing temporarily, set "1" in "#1219 aux03/bit1 (Stop high-speed PC monitoring function)". Disable the monitoring function only as a temporary measure.)	
<b>EMG</b>	<b>Emergency stop</b>	PARA
	<b>Details</b>	
	Setting of the door open II fixed device is illegal. Setting of the parameters for dog signal random assignment is illegal.	
	<b>Remedy</b>	
	•Correct the "#1155 DOOR_m" and "#1156 DOOR_s" settings. (When the door open II fixed device is not used, set "#1155 DOOR_m" and "#1156 DOOR_s" to "100".) •Correct the "#2073 zrn_dog (Origin dog Random assignment device)", "#2074 H/W_OT+ (H/W OT+ Random assignment device)", "#2075 H/W_OT- (H/W OT- Random assignment device)" and "#1226 aux10/bit5 (Arbitrary allocation of dog signal)" settings.	

EMG	Emergency stop	LINK
	<p><b>Details</b></p> <p>An emergency stop occurs when the FROM/TO instruction is not executed within 500ms.</p> <p><b>Remedy</b></p> <ul style="list-style-type: none"> <li>•Execute the FROM/TO instruction one or more times every 500ms.</li> </ul> <p>The time in which no interrupt request is issued from MELSEC is measured and stored in the following R registers:</p> <p>R10190: Current timeout counter  R10191: Maximum timeout counter after power ON  R10192: Maximum timeout counter after system is started up (this is backed up)</p> <p><b>Details</b></p> <p>MELSEC is in error and reset states.</p> <p><b>Remedy</b></p> <ul style="list-style-type: none"> <li>•Check the MELSEC states.</li> </ul> <p><b>Details</b></p> <p>The contents of MELSEC-specific code area in buffer memory have been damaged.</p> <p><b>Remedy</b></p> <ul style="list-style-type: none"> <li>•Check the MELSEC states.</li> </ul> <p><b>Details</b></p> <p>PLC serial link communication has stopped.</p> <p><b>Remedy</b></p> <ul style="list-style-type: none"> <li>•Check the CC-Link card wiring and the external sequencer transmission.</li> <li>•Check the link communication errors shown on the diagnostic screen.</li> </ul>	
	<p><b>Details</b></p> <p>The preparation sequence is not sent from the master station. Otherwise, the contents of the received preparation sequence are inconsistent with those of the parameters, so that the usual sequence cannot be started.</p> <p><b>Remedy</b></p> <ul style="list-style-type: none"> <li>•Check that the CC-Link card switch setting and wiring as well as the external sequencer transmission are normal.</li> <li>•Check the diagnostic screen for link communication errors.</li> </ul>	WAIT
	<p><b>Details</b></p> <p>The CC-Link card is operating incorrectly.  Switch/parameter settings for the CC-Link card are incorrect.</p> <p><b>Remedy</b></p> <ul style="list-style-type: none"> <li>•Replace the CC-Link card.</li> <li>•Correct the switch/parameter settings for the CC-Link card.</li> </ul>	XTEN
	<p><b>Details</b></p> <p>The sequence program has an illegal code.</p> <p><b>Remedy</b></p> <ul style="list-style-type: none"> <li>•Correct any illegal device Nos. or constants in the sequence program.</li> </ul>	LAD
	<p><b>Details</b></p> <p>The "emergency stop" signal for power supply is significant (open) because the external emergency stop function for power supply is enabled.</p> <p><b>Remedy</b></p> <ul style="list-style-type: none"> <li>•Cancel the "emergency stop" signal.</li> <li>•Check for any broken wires.</li> </ul>	CVIN



EMG	Emergency stop	MCT
	<p><b>Details</b></p> <p>The contactor shutoff test is being executed.</p> <p>Safety-related I/O observation has not started, while "#51595 SIO_StartCond" is 1.</p> <p><b>Remedy</b></p> <ul style="list-style-type: none"> <li>•The emergency stop is reset automatically after the contactor shutoff is confirmed.</li> <li>•If the contactor shutoff is not confirmed within 5 seconds after the "contactor shutoff test" signal (Y742) has been input, the "contactor welding detected" alarm occurs and the emergency stop status remains.</li> <li>•Make sure that the contactor's auxiliary b contact signal is correctly output to the device that is set in "#1330 MC_dp1", "#1331 MC_dp2", "#1339 MC_dp3" and "#1340 MC_dp4" (Contactor weld detection device 1,2,3 and 4), and then turn the power ON again.</li> <li>•Make sure that the safety I/O device is supplied with power, before turning ON the safety I/O observation start request signal (ZR416/Bit1).</li> </ul>	
	<p><b>Details</b></p> <p>The data backup for power failure might not have been executed successfully at the previous power failure.</p> <p><b>Remedy</b></p> <ul style="list-style-type: none"> <li>•If this message appears frequently, the power supply may be deteriorated. Contact the service center.</li> </ul>	IPWD
	<p><b>Details</b></p> <p>The encoder replacement operation is in progress.</p> <p><b>Remedy</b></p> <ul style="list-style-type: none"> <li>•Complete the encoder replacement operation on the "ABS. POSITION SET" screen.</li> </ul>	ENC
	<p><b>Details</b></p> <ul style="list-style-type: none"> <li>•Emergency stop "LINE" was retained due to a momentary OFF of the external emergency stop signal.</li> <li>•The emergency stop signal of the drive unit was detected while Ready ON was active on the NC.</li> <li>•The emergency stop signal of the drive unit cannot be canceled.</li> </ul> <p><b>Remedy</b></p> <ul style="list-style-type: none"> <li>•Check the alarm history. If Emergency stop "EXIN" was issued immediately prior to Emergency stop "LINE", check the wiring of the external emergency stop. Emergency stop "LINE" can be canceled by activating the external emergency stop.</li> <li>•Check the connection of the drive unit.</li> </ul>	LINE

## Computer Link Errors (L)

<b>L01</b>	<b>Timeout error</b>	0004
<b>Details</b>		
Communication ended with timeout. (CNC has a 248-byte receive buffer. The time during which CNC receives 248 bytes exceeds the 'TIME-OUT' value set in the I/O device parameter.)		
<b>Remedy</b>		
<ul style="list-style-type: none"> <li>•Set a greater timeout value in the input/output device parameter.</li> <li>•Check the software in HOST and make sure that the HOST transmits data in response to DC1(data request) from CNC.</li> <li>•Set '#9614 START CODE' to '0'.</li> </ul>		
<b>L01</b>	<b>Host ER signal OFF</b>	0010
<b>Details</b>		
ER signal in HOST (or DR signal in CNC) is not turned ON.		
<b>Remedy</b>		
<ul style="list-style-type: none"> <li>•Check for any disconnected cable.</li> <li>•Check for any broke wire.</li> <li>•Make sure that the HOST power is turned ON.</li> </ul>		
<b>L01</b>	<b>Parity H error</b>	0015
<b>Details</b>		
Communication ended with parity H.		
<b>Remedy</b>		
<ul style="list-style-type: none"> <li>•Check the software in HOST and make sure that the data to be transmitted to CNC is ISO code.</li> </ul>		
<b>L01</b>	<b>Parity V error</b>	0016
<b>Details</b>		
Communication ended with parity V.		
<b>Remedy</b>		
<ul style="list-style-type: none"> <li>•Correct the data to transmit to CNC.</li> </ul>		
<b>L01</b>	<b>Overrun error</b>	0017
<b>Details</b>		
CNC received 10 bytes or more data from HOST in spite of DC3 (request to stop data transfer) transmission from CNC to the HOST, which terminated the communication. CNC received 10 bytes or more data from HOST during the data transmission from CNC to the HOST.		
<b>Remedy</b>		
<ul style="list-style-type: none"> <li>•Check the software in HOST and make sure that the HOST stops transmitting data within 10 bytes after receiving DC3.</li> <li>•Correct the software in HOST not to transmit data such as a command or header to CNC during receiving a machining program.</li> </ul>		

## User PLC Alarms (U)

(Note) U10 Illegal PLC (User PLC is illegal)

- "xx" in the lower 16 bits of the sub-status 1 indicates the program No. (0x01 to 0x78(in the hexadecimal form))
- The sub-alarm No. "yy" of sub- status 1 indicates the project No. ("yy" is not displayed when the maximum number of projects is 1)

(Note) For details of user PLC alarms, refer to "PLC Development Manual".

<b>U01</b>	<b>No user PLC</b>	-	-
<b>Details</b>			
No sequence program is included in the built-in ROM or temporary memory area.			
(1) Sequence program is not stored in the built-in ROM.			
(2) Sequence program is not written from the GX Developer/GX Works2 or internal PLC edit function.			
(3) Sequence program cannot be read due to broken built-in ROM.			
(4) No large capacity PLC additional specifications.			
<b>Remedy</b>			
(1) Write the sequence program from the GX Developer/GX Works2 or internal PLC edit function, and then execute the built-in ROM writing.			
(2) Check the presence of additional specification "Large PLC capacity" and reconsider the storable size.			
(3) If (1) or (2) does not solve the problem, there is a possibility that built-in ROM is broken.			
<b>U10</b>	<b>Illegal PLC</b>	0x04xx.yy	Step No.
<b>Details</b>			
Software instruction interruption illegal			
An error was found in data for the sequence program in execution.			
(1) Sequence program stored in the built-in ROM is broken.			
(2) Sequence program under development (before writing into F-ROM) is broken.			
<b>Remedy</b>			
Contact Mitsubishi.			
<b>U10</b>	<b>Illegal PLC</b>	0x100*	-
<b>Details</b>			
A H/W error was detected during the PLC execution.			
<b>Remedy</b>			
Contact Mitsubishi.			
<b>U10</b>	<b>Illegal PLC</b>	0x110*	-
<b>Details</b>			
The PLC system execution preparation failed.			
<b>Remedy</b>			
Contact Mitsubishi.			
<b>U10</b>	<b>Illegal PLC</b>	0x120*	-
<b>Details</b>			
Number of ladder over (at PLC system startup)			
The total number of "ladder files" stored in built-in ROM exceeded the maximum.			
<b>Remedy</b>			
Write "sequence program", "comment file", "PLC message file", and "symbolic information file" again.			

<b>U10</b>	<b>Illegal PLC</b>	0x130*	-
<b>Details</b>			
Number of data over (at PLC system startup)			
The total number of "comment files", "PLC message files", and "symbolic information files" stored in built-in ROM exceeded the maximum.			
<b>Remedy</b>			
Remedy the error in either of the following methods.			
(1) Select [Format PLC memory] with GX Developer/GX Works2 and format the memory after setting [Target memory] to [Memory card(RAM)]. After that, write "comment file", "PLC message file", and "symbolic information file" again.			
(2) Create a ladder with [Add New Data] in built-in PLC editing function and execute "Format". After that, write "sequence program", "comment file", "PLC message file", and "symbolic information file" again.			
<b>U10</b>	<b>Illegal PLC</b>	0x20xx.yy	Step No.
<b>Details</b>			
Label branching error (Before executing PLC)			
Occurs only when the bit selection parameter (#6452 bit6) "branch destination label check valid" is set to "1".			
(1) The CJ and CALL instructions were placed to a nonexistent label.			
(2) The CJ instruction was placed to the global label. (Branching is possible only with the CALL instruction.)			
<b>Remedy</b>			
Check the branch destination of the CJ and CALL instructions existing in the steps occurred.			
<b>U10</b>	<b>Illegal PLC</b>	0x21xx.yy	Step No.
<b>Details</b>			
Label duplication error (Before executing PLC)			
(1) When using the multi-programming method:			
- Labels of common pointer are duplicated			
- Labels of local pointer are duplicated within the same file			
(2) When using the independent program method, labels are duplicated.			
<b>Remedy</b>			
Correct the duplication of the labels existing in the steps occurred.			
<b>U10</b>	<b>Illegal PLC</b>	0x22xx.yy	-
<b>Details</b>			
Local label over (Before executing PLC)			
* "Local label" is as "labels of local pointer".			
The boundary value set with the PC parameter (common pointer boundary value) has been exceeded by the total number of labels of local pointer.			
<b>Remedy</b>			
(1) Reduce the number of local labels used.			
- Use as sequentially as possible from P0.			
(2) Reset the PC parameter (common pointer boundary value).			
<b>U10</b>	<b>Illegal PLC</b>	0x230*.yy	-
<b>Details</b>			
Global label boundary value error (Before executing PLC)			
* "Global label" is as "labels of common pointer".			
The content of PC parameter (common pointer boundary value) is not normal.			
(1) When using the multi-programming method, a value greater than the maximum value is set.			
(2) When using the independent program method, the label boundary value of common pointer is set.			
<b>Remedy</b>			
(1) When using the multi-programming method, correct the common pointer boundary value to an appropriate value.			
(2) When using the independent program method, delete the common pointer boundary value.			

U10	Illegal PLC	0x24xx.yy	Step No.
<b>Details</b>			
Reserved label error (Before executing PLC)			
(1) When using the multi-programming method, disabled reserved label exists.			
(2) When using the independent program method, reserved labels are duplicated.			
<b>Remedy</b>			
(1) When using the multi-programming method, delete the reserved label.			
(2) When using the independent program method:			
- Delete the PC parameter program settings.			
- Correct the duplication of reserved labels.			
U10	Illegal PLC	0x25xx.yy	-
<b>Details</b>			
Program setting error (Before executing PLC)			
(1) When using the multi-programming method, PC parameter setting is not correct.			
- PC parameter (program setting) is not set.			
- Unstored program name is set.			
- The contents of the program name is abnormal.			
- More than the maximum number of programs that can be set (120 programs) are set.			
(2) When using the independent program method, multiple programs are stored.			
(3) When the multi-project is valid, the sum of all projects exceeds the number of the programs which can be set (120 programs).			
<b>Remedy</b>			
(1) When using the multi-programming method, check the PC parameter program settings.			
- Check the program settings.			
- Check the program name stored in the NC.			
- Review the program name and rename it if necessary.			
e.g. The program name and the M device number in the PLC program are overlapped.			
- Set the number to 120 or less.			
(2) When using the independent program method:			
- Store only one program file.			
(3) When the multi-project is valid, set the number of programs that can be set to be less than 120 programs as the sum of all projects.			
U10	Illegal PLC	0x26xx.yy	-
<b>Details</b>			
RET instruction error			
(1) RET instruction was not executed at the branch destination of the CALL instruction.			
(2) RET instruction was executed without execution of CALL instruction.			
<b>Remedy</b>			
Check the following matters for the entire sequence program to be executed.			
(1) Check if RET instruction is programmed at the end of sub-routine			
(2) Check if diverged to the other operation in the middle of sub-routine and RET instruction is not executed.			
(3) Check if jumped to the END reservation label (P4005) in the middle of sub-routine.			
(4) Check if there is delimiter (FEND instruction) between adjacent program and sub-routine program.			
U10	Illegal PLC	0x27xx.yy	Step No.
<b>Details</b>			
Ladder code error (Before executing PLC)			
An error was found in data for the sequence program to be executed.			
(1) Disabled PLC instruction is used.			
(2) Sequence program stored in the built-in ROM is broken.			
(3) Sequence program under development (before writing into the built-in ROM) is broken.			
<b>Remedy</b>			
Transferring, storing and F-ROM writing of the sequence program must be re-executed with the GX Developer/GX Works2 or PLC on-board edit function.			

<b>U10</b>	<b>Illegal PLC</b>	0x280*	-
<b>Details</b>			
No main processing ladders (Before executing PLC)			
Main processing program to be executed cannot be identified.			
(1) When using the multi-programming method, main processing "scan" is not set in the PC parameter (program setting).			
(2) When using the independent program method, no reservation ladder for the main processing ladder is available.			
<b>Remedy</b>			
(1) When using the multi-programming method, check the PC parameter program settings.			
(2) When using the independent program method, add the reservation label (P4002) for the medium speed ladder.			
<b>U10</b>	<b>Illegal PLC</b>	0x29xx.yy	-
<b>Details</b>			
Execution area over (Before executing PLC)			
The total number of steps for the ladder to be executed has exceeded the size of PLC processor execution area.			
<b>Remedy</b>			
Check the PC parameter (program setting) and set so that the total number of steps for the ladder to be executed does not exceed the PLC processor execution area.			
<b>U10</b>	<b>Illegal PLC</b>	0x30xx.yy	Step No.
<b>Details</b>			
FOR instruction nesting over			
17th level of nesting for FOR instruction was executed.			
<b>Remedy</b>			
Check the number of FOR instruction's nesting depth in the steps to which the error occurred, and limit the number to 16 or less.			
<b>U10</b>	<b>Illegal PLC</b>	0x31xx.yy	Step No.
<b>Details</b>			
NEXT instruction error			
(1) NEXT instruction was executed before FOR instruction.			
(2) After FOR instruction, END(FEND) was executed before NEXT instruction.			
<b>Remedy</b>			
(1) Check and correct the NEXT instruction in the step to which the error occurred.			
(2) Check and correct the ladder circuit of the program to which the error occurred. (Note that the step No. at the error position is displayed as "0".)			
- Check if JMP, CALL, CJ instructions were executed between FOR and NEXT instruction, and NEXT instruction was jumped.			
- Check if FOR instruction and NEXT instruction are all paired.			
<b>U10</b>	<b>Illegal PLC</b>	0x32xx.yy	Step No.
<b>Details</b>			
BREAK instruction error			
BREAK was executed outside the range between FOR and NEXT instruction.			
<b>Remedy</b>			
Check and correct the BREAK instruction in the step to which the error occurred.			
<b>U10</b>	<b>Illegal PLC</b>	0x400*	-
<b>Details</b>			
PLC system error			
<b>Remedy</b>			
Contact Mitsubishi.			



<b>U10</b>	<b>Illegal PLC</b>	0x500*	-
<b>Details</b>			
Maximum project No. illegal (at PLC system startup)			
Multi-project parameter setting is illegal (due to the following reason).			
•The value outside the setting range (1 to number of usable project) was detected.			
<b>Remedy</b>			
(1) Check the presence of the expansion project additional specification and reconsider the setting range.			
(2) The multi-project parameter (maximum project No.) setting is illegal. Set the multi-project parameter again.			
(3) If (1) or (2) does not solve the problem, there is a possibility that the NC system is broken. Contact Mitsubishi.			
<b>U10</b>	<b>Illegal PLC</b>	0x510*	-
<b>Details</b>			
Project ratio illegal			
Multi-project parameter setting is illegal (due to the following reason).			
•It was detected that the total of ratios of all projects was outside the range from 0 to 100.			
<b>Remedy</b>			
(1) The multi-project parameter (project ratio) setting is illegal. Set the multi-project parameter again.			
(2) If (1) does not solve the problem, there is a possibility that the NC system is broken. Contact Mitsubishi.			
<b>U10</b>	<b>Illegal PLC</b>	0x520*	-
<b>Details</b>			
Temporary memory area over (at the PLC system startup)			
Multi-project parameter setting is illegal (due to the following reason).			
•The ratio to which the area after the project ratio setting is smaller than the size of ladder stored in the temporary memory area was detected.			
<b>Remedy</b>			
(1) Check the presence of the large-capacity PLC additional specification and reconsider the size that can be stored.			
(2) The multi-project parameter (project ratio) setting is illegal. Set the multi-project parameter again.			
(3) If (1) or (2) does not solve the problem, there is a possibility that the NC system is broken. Contact Mitsubishi.			
<b>U10</b>	<b>Illegal PLC</b>	0x530*	-
<b>Details</b>			
Built-in ROM area over (at the PLC system startup)			
Multi-project parameter setting is illegal (due to the following reason).			
•The ratio to which the area after the project ratio setting is smaller than the size of ladder stored in the built-in ROM area was detected.			
<b>Remedy</b>			
(1) Check the presence of the large-capacity PLC additional specification and reconsider the size that can be stored.			
(2) The multi-project parameter (project ratio) setting is illegal. Set the multi-project parameter again.			
(3) If (1) or (2) does not solve the problem, there is a possibility that the NC system is broken. Contact Mitsubishi.			
<b>U10</b>	<b>Illegal PLC</b>	0x540*	-
<b>Details</b>			
Comment area over (at the PLC system startup)			
Multi-project parameter setting is illegal (due to the following reason).			
•The ratio to which the area after the project ratio setting is smaller than the size of comment and message stored in the built-in ROM area.			
<b>Remedy</b>			
(1) The multi-project parameter (project ratio) setting is illegal. Set the multi-project parameter again.			
(2) If (1) does not solve the problem, there is a possibility that the NC system is broken. Contact Mitsubishi.			

<b>U10</b>	<b>Illegal PLC</b>	0x550*	-
<b>Details</b>			
Execution project illegal (at the PLC system startup)			
Multi-project parameter setting is illegal (due to the following reasons).			
<ul style="list-style-type: none"> <li>♦The value outside the setting range (ON/OFF) was detected.</li> <li>♦All execution projects are OFF.</li> </ul>			
<b>Remedy</b>			
(1) The multi-project parameter (execution project) setting is illegal. Set the multi-project parameter again.			
(2) If (1) does not solve the problem, there is a possibility that the NC system is broken. Contact Mitsubishi.			
<b>U10</b>	<b>Illegal PLC</b>	0x560*	-
<b>Details</b>			
Project execution order illegal (at the PLC system startup)			
Multi-project parameter setting is illegal (due to the following reasons).			
<ul style="list-style-type: none"> <li>♦The value outside the setting range (1 to 6) was detected.</li> <li>♦The redundant project execution order number was detected.</li> </ul>			
<b>Remedy</b>			
(1) The multi-project parameter (project execution order) setting is illegal. Set the multi-project parameter again.			
(2) If (1) does not solve the problem, there is a possibility that the NC system is broken. Contact Mitsubishi.			
<b>U10</b>	<b>Illegal PLC</b>	0x570*	-
<b>Details</b>			
Parameter setting illegal for the number of common device points (at PLC system startup)			
Multi-project parameter setting is illegal (due to the following reasons).			
<ul style="list-style-type: none"> <li>♦The value outside the setting range (0 to the minimum number of points in all projects) was detected.</li> <li>♦It was detected that the number of points was not a multiple of 16.</li> </ul>			
<b>Remedy</b>			
(1) Check the presence of the expansion project additional specification and reconsider the setting range.			
(2) The multi-project parameter setting is illegal. Set the multi-project parameter again.			
(3) If (1) or (2) does not solve the problem, there is a possibility that the NC system is broken. Contact Mitsubishi.			
<b>U10</b>	<b>Illegal PLC</b>	0x580*.yy	-
<b>Details</b>			
Parameter setting illegal for number of device points (at PLC system startup)			
The parameter setting for the number of device points is illegal (due to the following reasons).			
<ul style="list-style-type: none"> <li>♦The total number of points in one project 29K or more was set.</li> <li>♦The illegal value (-1 point or less, or 61441 points or more) for the number of device points was detected.</li> <li>♦It was detected that the number of device points was not a multiple of 16.</li> <li>♦The number outside the usable number of device points in whole projects was detected.</li> </ul>			
<b>Remedy</b>			
(1) The parameter setting for the number of device points is illegal. Set the parameter of the number of device points again and reboot the system.			
(2) If (1) does not solve the problem, there is a possibility that the NC system is broken. Contact Mitsubishi.			
<b>U10</b>	<b>Illegal PLC</b>	0x700*.yy	-
<b>Details</b>			
Caution; Ladder program writing during RUN is disabled (In independent program method)			
With RUN write ON, sequence program is operated in independent program method. Run write is not available with this condition.			
<b>Remedy</b>			
The ladder program writing (RUN write) can not be used in independent program method.			
Disable RUN write, or change the method into multi-program one.			

U10	Illegal PLC	0x71xx.yy	Step No.
<b>Details</b>			
Caution; Ladder program writing during RUN is disabled (common pointer is used in high-speed processing) With RUN write is ON, high-speed program with common pointer is running. RUN write is not available with this condition.			
<b>Remedy</b>			
RUN write is not available when high-speed processing with common pointer is running. Change the high-speed processing program to the one without common pointer.			
U10	Illegal PLC	0x720*	-
<b>Details</b>			
Caution; Ladder program writing during RUN is disabled (high-speed processing size is exceeding) With RUN write ON, the execution size of high-speed processing program has exceeded 4000 steps. RUN write is not available with this condition.			
<b>Remedy</b>			
RUN write is not available when execution size of high-speed processing program exceeds 4000 steps. Edit the high-speed processing program to reduce the execution size to 4000 steps or less. (When multi-project is valid, edit the program to reduce the execution size to 4000 steps or less in total of all the project.)			
U10	Illegal PLC	0x730*.yy	-
<b>Details</b>			
Caution; Ladder program writing during RUN is disabled (number of labels in high-speed processing is beyond the capacity) * "Local label" is as "labels of local pointer". With RUN write ON, the number of labels of local pointer in high-speed processing program has exceeded 256. RUN write is not available with this condition.			
<b>Remedy</b>			
RUN write is not available when the number of labels of local pointer in high-speed processing program exceeds 256. Edit the high-speed program to reduce the number of labels of local pointer to less than 256. (When multi-project is valid, edit the program to reduce the number of labels of local pointer to less than 256 per project.)			
U10	Illegal PLC	0x80xx.yy	Step No.
<b>Details</b>			
Software exceptional interruption (BCD instruction error) has occurred. With BCD and DBCD instructions, BIN value outside its input range was attempted to be converted into BCD.			
<b>Remedy</b>			
Check the usage of BCD, DBCD instructions existing in the steps occurred.			
U10	Illegal PLC	0x81xx.yy	Step No.
<b>Details</b>			
Software exceptional interruption (BIN instruction error) has occurred. With BIN and DBIN instructions, BCD value outside its input range was attempted to be converted into BIN.			
<b>Remedy</b>			
Check the usage of BIN, DBIN instructions existing in the steps occurred.			
U10	Illegal PLC	0x82xx.yy	Step No.
<b>Details</b>			
Software exceptional interruption (Bus error) has occurred.			
<b>Remedy</b>			
Contact Mitsubishi.			

<b>U10</b>	<b>Illegal PLC</b>	0x83xx.yy	Step No.
<b>Details</b>			
Software exceptional interruption (Unmounted instruction error) has occurred.			
(1) When the bit selection parameter (#6452 bit6) "branch destination label check valid" is set to "0", jumped to an undefined label.			
(2) Sequence program in execution is broken.			
<b>Remedy</b>			
(1) Set the bit selection parameter (#6452 bit6) "branch destination label check valid" to "1" and check the branching step to the undefined label.			
(2) Contact Mitsubishi.			
<b>U10</b>	<b>Illegal PLC</b>	0x84xx.yy	Step No.
<b>Details</b>			
Software exceptional interruption (Instruction format error) has occurred.			
<b>Remedy</b>			
Contact Mitsubishi.			
<b>U10</b>	<b>Illegal PLC</b>	0x85xx.yy	Step No.
<b>Details</b>			
Software exceptional interruption (Instruction bus error) has occurred.			
(1) When the bit selection parameter (#6452 bit6) "branch destination label check valid" is set to "0", jumped to an undefined label.			
(2) Sequence program in execution is broken.			
<b>Remedy</b>			
(1) Set the bit selection parameter (#6452 bit6) "branch destination label check valid" to "1" and check the branching step to the undefined label.			
(2) Contact Mitsubishi.			
<b>U10</b>	<b>Illegal PLC</b>	0x86xx.yy	Step No.
<b>Details</b>			
Software exceptional interruption (CALL/RET instruction error) has occurred.			
<b>Remedy</b>			
Contact Mitsubishi.			
<b>U10</b>	<b>Illegal PLC</b>	0x87xx.yy	Step No.
<b>Details</b>			
Software exceptional interruption (memory area error) has occurred.			
<b>Remedy</b>			
Contact Mitsubishi.			
<b>U10</b>	<b>Illegal PLC</b>	0x8Bxx.yy	Step No.
<b>Details</b>			
Software exceptional interruption (ASYNC BUS error) has occurred.			
<b>Remedy</b>			
Contact Mitsubishi.			
<b>U50</b>	<b>PLC stopped</b>		
<b>Details</b>			
The ladder is stopped.			
<b>Remedy</b>			
Run the PLC.			

---

<b>U55</b>	<b>PLC stopped / is not saved</b>
<b>Details</b>	
The ladder is stopped and the edited sequence program is not stored in the built-in ROM. (The contents of temporary memory area and sequence program in the built-in ROM are mismatched.)	
<b>Remedy</b>	
Run the PLC. Use GX Developer/GX Works2 or the built-in PLC edit function to perform write to the built-in ROM.	
<b>U60</b>	<b>Ladder is not saved</b>
<b>Details</b>	
The edited sequence program is not stored in the built-in ROM. (The contents of temporary memory area and sequence program in the built-in ROM are mismatched.)	
<b>Remedy</b>	
Use GX Developer/GX Works2 or the built-in PLC edit function to perform write to the built-in ROM.	

---

## Network Service Errors (N)

<b>N001</b>	<b>Modem initial error</b>
	<p><b>Details</b></p> <p>An error occurred in the modem connection at the power ON.</p> <p><b>Remedy</b></p> <ul style="list-style-type: none"> <li>•Check the connection between the NC and modem, connection port and power supply to modem.</li> </ul>
<b>N002</b>	<b>Redial over</b>
	<p><b>Details</b></p> <ul style="list-style-type: none"> <li>•The number of redials exceeded due to the dial transmission failure.</li> </ul> <p><b>Remedy</b></p> <ul style="list-style-type: none"> <li>•Wait a while, and then dial again.</li> </ul>
<b>N003</b>	<b>TEL unconnect</b>
	<p><b>Details</b></p> <ul style="list-style-type: none"> <li>•The phone line is not connected.</li> </ul> <p><b>Remedy</b></p> <ul style="list-style-type: none"> <li>•Check for any disconnection in the modem's phone line.</li> </ul>
<b>N004</b>	<b>Net communication error</b>
	<p><b>Details</b></p> <ul style="list-style-type: none"> <li>•An error other than the above occurred during communication.</li> </ul> <p><b>Remedy</b></p> <ul style="list-style-type: none"> <li>•Note down how the error occurred and contact the service center.</li> </ul>
<b>N005</b>	<b>Invalid net communication</b>
	<p><b>Details</b></p> <ul style="list-style-type: none"> <li>•The modem connection port is being used for another function such as input/output.</li> <li>•The modem connection port settings are incorrect.</li> </ul> <p><b>Remedy</b></p> <ul style="list-style-type: none"> <li>•Stop using the modem connection port with the other function, and then turn the power ON again.</li> <li>•Correct the settings of the modem connection port.</li> </ul>
<b>N006</b>	<b>Received result of diagnosis</b>
	<p><b>Details</b></p> <ul style="list-style-type: none"> <li>•A diagnosis data file has been received.</li> </ul> <p><b>Remedy</b></p> <ul style="list-style-type: none"> <li>•Clear the message.</li> </ul>
<b>N007</b>	<b>Send data size over</b>
	<p><b>Details</b></p> <ul style="list-style-type: none"> <li>•A file larger than Anshin-net server capacity (64Kbyte) has been transmitted in machining data sharing.</li> </ul> <p><b>Remedy</b></p> <ul style="list-style-type: none"> <li>•Reduce the size of machining program file so that it won't exceed the capacity of Anshin-net server.</li> </ul>
<b>N008</b>	<b>No file on server</b>
	<p><b>Details</b></p> <ul style="list-style-type: none"> <li>•The file reception failed in machining data sharing because no file exists on Anshin-net server.</li> </ul> <p><b>Remedy</b></p> <ul style="list-style-type: none"> <li>•Confirm that a machining program file exists on Anshin-net server before receiving it.</li> </ul>

---

<b>N009</b>	<b>Password error</b>
<b>Details</b>	
♦The file reception failed in machining data sharing due to a wrong password.	
<b>Remedy</b>	
♦Input the password again.	
<b>N010</b>	<b>Customer number error</b>
<b>Details</b>	
♦The file reception failed in machining data sharing due to a wrong customer number.	
<b>Remedy</b>	
♦Input the customer number again.	
<b>N011</b>	<b>Storage capacity over</b>
<b>Details</b>	
♦The file reception failed in machining data sharing because the size of the file to be received is bigger than free space in the NC.	
<b>Remedy</b>	
♦Ensure sufficient free space in the NC.	
<b>N012</b>	<b>File deletion error</b>
<b>Details</b>	
♦A file on Anshin-net server cannot be deleted in machining data sharing.	
<b>Remedy</b>	
♦Confirm that the file exists on Anshin-net server.	
♦Note down how the error occurred and contact the service center.	

---





## Program Errors (P)

These alarms occur during automatic operation, and the causes of these alarms are mainly program errors which occur, for instance, when mistakes have been made in the preparation of the machining programs or when programs which conform to the specification have not been prepared.

<b>P10</b>	<b>No. of simultaneous axes over</b>
<b>Details</b>	
The number of axis addresses programmed in a block exceeds the specified maximum.	
<b>Remedy</b>	
<ul style="list-style-type: none"> <li>•Divide the command programmed in the block into two blocks.</li> <li>•Check the specifications.</li> </ul>	
<b>P11</b>	<b>Illegal axis address</b>
<b>Details</b>	
The axis address commanded by the program does not match any of the ones set by the parameter.	
<b>Remedy</b>	
<ul style="list-style-type: none"> <li>•Correct the axis names in the program.</li> </ul>	
<b>P20</b>	<b>Division error</b>
<b>Details</b>	
<ul style="list-style-type: none"> <li>•The issued axis command cannot be divided by the command unit.</li> <li>•A cutting feed command has been issued to the index table indexing axis when the parameter "#2580 index_ Gcmd" is set to "1".</li> </ul>	
<b>Remedy</b>	
<ul style="list-style-type: none"> <li>•Correct the program.</li> </ul>	
<b>P29</b>	<b>Not accept command</b>
<b>Details</b>	
The command has been issued when it is impossible.	
<ul style="list-style-type: none"> <li>•The normal line control command (G40.1, G41.1, G42.1) has been issued during the modal in which the normal line control is not acceptable.</li> <li>•The command has been issued during the modal in which the two-part system simultaneous thread cutting is not acceptable.</li> <li>•A workpiece coordinate system preset command (G92.1) has been issued during tool length compensation, nose R compensation or tool radius compensation.</li> </ul>	
<b>Remedy</b>	
<ul style="list-style-type: none"> <li>•Correct the program.</li> </ul>	
<b>P30</b>	<b>Parity H error</b>
<b>Details</b>	
The number of holes per character on the paper tape is even for EIA code and odd for ISO code.	
<b>Remedy</b>	
<ul style="list-style-type: none"> <li>•Check the paper tape.</li> <li>•Check the tape puncher and tape reader.</li> </ul>	
<b>P31</b>	<b>Parity V error</b>
<b>Details</b>	
The number of characters per block on the paper tape is odd.	
<b>Remedy</b>	
<ul style="list-style-type: none"> <li>•Make the number of characters per block on the paper tape even.</li> <li>•Set the parameter parity V selection OFF.</li> </ul>	

<b>P32</b>	<b>Illegal address</b>
<b>Details</b>	
An address not listed in the specifications has been used.	
<b>Remedy</b>	
<ul style="list-style-type: none"> <li>♦Correct the program address.</li> <li>♦Correct the parameter settings.</li> <li>♦Check the specifications.</li> </ul>	
<b>P33</b>	<b>Format error</b>
<b>Details</b>	
The command format in the program is not correct.	
<b>Remedy</b>	
<ul style="list-style-type: none"> <li>♦Correct the program.</li> </ul>	
<b>P34</b>	<b>Illegal G code</b>
<b>Details</b>	
<ul style="list-style-type: none"> <li>♦The commanded G code is not in the specifications.</li> </ul>	
An illegal G code was commanded during the coordinate rotation command.	
<ul style="list-style-type: none"> <li>♦G51.2 or G50.2 was commanded when the rotary tool axis No. (the parameter "#1501polyax") was set to "0".</li> </ul>	
G51.2 or G50.2 was commanded when the tool axis was set to the linear axis (the parameter "#1017 rot" = 0).	
<b>Remedy</b>	
<ul style="list-style-type: none"> <li>♦Check and correct the G code address in the program.</li> <li>♦Check the parameter setting values.</li> </ul>	
<b>P35</b>	<b>Setting value range over</b>
<b>Details</b>	
The setting range for the addresses has been exceeded.	
<b>Remedy</b>	
<ul style="list-style-type: none"> <li>♦Correct the program.</li> </ul>	
<b>P36</b>	<b>Program end error</b>
<b>Details</b>	
"EOR" has been read during tape and memory mode.	
<b>Remedy</b>	
<ul style="list-style-type: none"> <li>♦Enter the M02 and M30 command at the end of the program.</li> <li>♦Enter the M99 command at the end of the subprogram.</li> </ul>	
<b>P37</b>	<b>O, N number zero</b>
<b>Details</b>	
"0" has been specified for program or sequence No.	
<b>Remedy</b>	
<ul style="list-style-type: none"> <li>♦Designate program Nos. within a range from 1 to 99999999.</li> <li>♦Designate sequence Nos. within a range from 1 to 99999999.</li> </ul>	
<b>P38</b>	<b>No spec: Add. Op block skip</b>
<b>Details</b>	
"/n" has been issued while the optional block skip addition is not in the specifications.	
<b>Remedy</b>	
<ul style="list-style-type: none"> <li>♦Check the specifications.</li> </ul>	

<b>P39</b>	<b>No specifications</b>
<b>Details</b>	
<ul style="list-style-type: none"> <li>•A non-specified G code was commanded.</li> <li>•The selected operation mode is out of the option setting.</li> <li>•The selected operation mode is out of the parameter setting.</li> </ul>	
<b>Remedy</b>	
<ul style="list-style-type: none"> <li>•Check the specifications.</li> <li>•Check the parameter setting values.</li> </ul>	
<b>P40</b>	<b>Pre-read block error</b>
<b>Details</b>	
When tool radius compensation is executed, there is an error in the pre-read block and so the interference check is disabled.	
<b>Remedy</b>	
<ul style="list-style-type: none"> <li>•Reconsider the program.</li> </ul>	
<b>P45</b>	<b>G code combination error</b>
<b>Details</b>	
The combination of G codes in a block is inappropriate. A part of unmodal G codes and modal G codes cannot be commanded in a same block.	
<b>Remedy</b>	
Correct the combination of G codes. Separate the incompatible G codes into different blocks.	
<b>P48</b>	<b>Restart pos return incomplete</b>
<b>Details</b>	
A travel command was issued before the execution of the block that had been restart-searched.	
<b>Remedy</b>	
<ul style="list-style-type: none"> <li>•Carry out program restart again.</li> </ul> Travel command cannot be executed before the execution of the block that has been restart-searched.	
<b>P49</b>	<b>Invalid restart search</b>
<b>Details</b>	
Restart search was attempted for a block that comes after any of the following command blocks: 3-dimensional circular interpolation, cylindrical interpolation, polar coordinate interpolation, milling interpolation, tool center point control, simple tool center point control, inclined surface machining, simple inclined surface machining, workpiece installation error compensation, axis name switch, mixed control, machining condition selection I, sub part system control I, sub part system control II, or direct command mode.	
<b>Remedy</b>	
<ul style="list-style-type: none"> <li>•Reconsider the restart search position.</li> </ul>	
<b>P50</b>	<b>No spec: Inch/Metric change</b>
<b>Details</b>	
Inch/Metric changeover (G20/G21) command was issued while the function is out of specifications.	
<b>Remedy</b>	
<ul style="list-style-type: none"> <li>•Check the specifications.</li> </ul>	
<b>P60</b>	<b>Compensation length over</b>
<b>Details</b>	
The commanded movement distance is excessive (over 2 <sup>31</sup> ).	
<b>Remedy</b>	
<ul style="list-style-type: none"> <li>•Correct the command range for the axis address.</li> </ul>	

<b>P61</b>	<b>No spec: Unidirectional posit.</b>
<b>Details</b>	
Unidirectional positioning (G60) was commanded while the function is out of specifications.	
<b>Remedy</b>	
♦Check the specifications.	
<b>P62</b>	<b>No F command</b>
<b>Details</b>	
♦No feed rate command has been issued.	
♦There is no F command in the cylindrical interpolation or polar coordinate interpolation immediately after the G95 mode is commanded.	
<b>Remedy</b>	
♦The default movement modal command at power ON is G01. This causes the machine to move without a G01 command if a movement command is issued in the program, and an alarm results. Use an F command to specify the feed rate.	
♦Specify F with a thread lead command.	
<b>P65</b>	<b>No spec: High speed mode 3</b>
<b>Details</b>	
High-speed mode III (G05 P3) was commanded while the function is out of specifications.	
<b>Remedy</b>	
♦Check whether the specifications are provided for the high-speed mode III.	
<b>P67</b>	<b>F value is exceeding the limit</b>
<b>Details</b>	
F's value in an F or ,F command is exceeding the command range.	
<b>Remedy</b>	
♦Check and correct F or ,F command in the program.	
<b>P70</b>	<b>Arc end point deviation large</b>
<b>Details</b>	
♦There is an error in the arc start and end points as well as in the arc center.	
♦The difference of the involute curve through the start point and the end point is large.	
♦When arc was commanded, one of the two axes configuring the arc plane was a scaling valid axis.	
<b>Remedy</b>	
♦Correct the numerical values of the addresses that specify the start and end points, arc center as well as the radius in the program.	
♦Correct the "+" and "-" directions of the address numerical values.	
♦Check for the scaling valid axis.	
<b>P71</b>	<b>Arc center error</b>
<b>Details</b>	
♦An arc center cannot be obtained in R-specified circular interpolation.	
♦A curvature center of the involute curve cannot be obtained.	
<b>Remedy</b>	
♦Correct the numerical values of the addresses in the program.	
♦Correct the start and end points if they are inside of the base circle for involute interpolation. When carrying out tool radius compensation, make sure that the start and end points after compensation will not be inside of the base circle for involute interpolation.	
♦Correct the start and end points if they are at an even distance from the center of the base circle for involute interpolation.	

<b>P72</b>	<b>No spec: Helical cutting</b>
<b>Details</b>	
A helical command has been issued though it is out of specifications.	
<b>Remedy</b>	
<ul style="list-style-type: none"> <li>•Check whether the specifications are provided for the helical cutting.</li> <li>•An Axis 3 command has been issued by the circular interpolation command. If there is no helical specification, move the linear axis to the next block.</li> </ul>	
<b>P73</b>	<b>No spec: Spiral cutting</b>
<b>Details</b>	
A spiral command was issued though it is out of specifications.	
<b>Remedy</b>	
<ul style="list-style-type: none"> <li>•Issue the G02.1 and G03.1 commands for circular interpolation.</li> <li>•Check whether the specifications are provided for the spiral cutting.</li> </ul>	
<b>P74</b>	<b>Can't calculate 3DIM arc</b>
<b>Details</b>	
The 3-dimension circular cannot be obtained because the end block was not specified during 3-dimension circular interpolation supplementary modal.	
The 3-dimension circular cannot be obtained due to an interruption during 3-dimension circular interpolation supplementary modal.	
<b>Remedy</b>	
<ul style="list-style-type: none"> <li>•Correct the program.</li> </ul>	
<b>P75</b>	<b>3DIM arc illegal</b>
<b>Details</b>	
An illegal G code was issued during 3-dimension circular interpolation modal.	
Otherwise, 3-dimension circular interpolation command was issued during a modal for which a 3-dimension circular interpolation command cannot be issued.	
<b>Remedy</b>	
<ul style="list-style-type: none"> <li>•Correct the program.</li> </ul>	
<b>P76</b>	<b>No spec: 3DIM arc interpolat</b>
<b>Details</b>	
G02.4/G03.4 was commanded though there is no 3-dimension circular interpolation specification.	
<b>Remedy</b>	
<ul style="list-style-type: none"> <li>•Check the specifications.</li> </ul>	
<b>P90</b>	<b>No spec: Thread cutting</b>
<b>Details</b>	
A thread cutting command was issued though it is out of specifications.	
<b>Remedy</b>	
<ul style="list-style-type: none"> <li>•Check the specifications.</li> </ul>	
<b>P93</b>	<b>Illegal pitch vaule</b>
<b>Details</b>	
An illegal thread lead (thread pitch) was specified at the thread cutting command.	
<b>Remedy</b>	
<ul style="list-style-type: none"> <li>•Correct the thread lead for the thread cutting command.</li> </ul>	
<b>P100</b>	<b>No spec: Cylindric interpolat</b>
<b>Details</b>	
A cylindrical interpolation command was issued though it is out of specifications.	
<b>Remedy</b>	
<ul style="list-style-type: none"> <li>•Check the specifications.</li> </ul>	

<b>P110</b>	<b>Plane select during figure rot</b>
<b>Details</b>	
Plane selection (G17/G18/G19) was commanded during figure rotation.	
<b>Remedy</b>	
♦Correct the machining program.	
<b>P111</b>	<b>Plane selected while coord rot</b>
<b>Details</b>	
Plane selection commands (G17, G18, G19) were issued during a coordinate rotation was being commanded.	
<b>Remedy</b>	
♦Always command coordinate rotation cancel after the coordinate rotation command, and then issue a plane selection command.	
<b>P112</b>	<b>Plane selected while R compen</b>
<b>Details</b>	
♦Plane selection commands (G17, G18, G19) were issued while tool radius compensation (G41, G42) and nose R compensation (G41, G42, G46) commands were being issued.	
♦Plane selection commands were issued after completing nose R compensation commands when there were no further axis movement commands after G40, and compensation has not been cancelled.	
<b>Remedy</b>	
♦Issue plane selection commands after completing (axis movement commands issued after G40 cancel command) tool radius compensation and nose R compensation commands.	
<b>P113</b>	<b>Illegal plane select</b>
<b>Details</b>	
The circular command axis does not correspond to the selected plane.	
<b>Remedy</b>	
♦Select a correct plane before issuing a circular command.	
<b>P114</b>	<b>Plane axis command error</b>
<b>Details</b>	
♦The axis specified in the fixed cycle for turning machining does not coincide with the selected plane.	
♦One or both of the selected plane axes have no travel when the fixed cycle for turning machining is commanded.	
<b>Remedy</b>	
♦Correct the plane selection before issuing the fixed cycle for turning machining.	
♦Correct the program so that the two axes of the selected plane are involved in the movement of the fixed cycle for turning machining.	
<b>P120</b>	<b>No spec: Feed per rotation</b>
<b>Details</b>	
Feed per rotation (G95) was commanded though it is out of specifications.	
<b>Remedy</b>	
♦Check the specifications.	
<b>P121</b>	<b>F0 command during arc modal</b>
<b>Details</b>	
F0 (F 1-digit feed) was commanded during the arc modal (G02/G03).	
<b>Remedy</b>	
♦Correct the machining program.	
<b>P122</b>	<b>No spec: Auto corner override</b>
<b>Details</b>	
An auto corner override command (G62) was issued though it is out of specifications.	
<b>Remedy</b>	
♦Check the specifications.	
♦Delete the G62 command from the program.	



<b>P123</b>	<b>No spec: High-accuracy control</b>
<b>Details</b>	
High-accuracy control command was issued though it is out of specifications.	
<b>Remedy</b>	
•Check the specifications.	
<b>P124</b>	<b>No spec: Inverse time feed</b>
<b>Details</b>	
•The inverse time option is not provided.	
<b>Remedy</b>	
•Check the specifications.	
<b>P125</b>	<b>G93 mode error</b>
<b>Details</b>	
•The issued G code command is illegal during G93 mode.	
•G93 command was issued during a modal for which inverse time feed cannot be performed.	
<b>Remedy</b>	
•Correct the program.	
<b>P126</b>	<b>Invalid cmnd in high-accuracy</b>
<b>Details</b>	
An illegal command was issued during the high-accuracy control mode.	
•A G code group 13 command was issued during the high-accuracy control mode.	
•Milling, cylindrical interpolation or pole coordinate interpolation was commanded during the high-accuracy control mode.	
<b>Remedy</b>	
•Correct the program.	
<b>P127</b>	<b>No spec: SSS Control</b>
<b>Details</b>	
The SSS control valid parameter has been set although there is no SSS control specification.	
<b>Remedy</b>	
•Check the specifications. Set "#8090 SSS ON" to "0" when there is no SSS control specification.	
<b>P128</b>	<b>Machin condtn select I disable</b>
<b>Details</b>	
Machining condition selection I was commanded during the mode where the selection command is unavailable.	
<b>Remedy</b>	
•Check the program and see whether any unavailable mode is included during machining condition selection I. If any, cancel that mode.	
<b>P129</b>	<b>Hi-speed Hi-accuracy both ON</b>
<b>Details</b>	
Both the high-accuracy control mode and high-speed machining mode are commanded simultaneously in a part system where the simultaneous use of the two modes is disabled.	
<b>Remedy</b>	
•Correct the setting of "#8040 High-speed high-accuracy control-enabled part system". Or correct the machining program so that the high-accuracy control mode is not used together with high-speed machining mode.	
<b>P130</b>	<b>2nd M function code illegal</b>
<b>Details</b>	
The 2nd miscellaneous function address, commanded in the program, differs from the address set in the parameters.	
<b>Remedy</b>	
•Correct the 2nd miscellaneous function address in the program.	

<b>P131</b>	<b>No spec: Cnst surface ctrl G96</b>
<b>Details</b>	
A constant surface speed control command (G96) was issued though it is out of specifications.	
<b>Remedy</b>	
<ul style="list-style-type: none"> <li>♦Check the specifications.</li> <li>♦Issue a rotation speed command (G97) instead of the constant surface speed control command (G96).</li> </ul>	
<b>P132</b>	<b>Spindle rotation speed S=0</b>
<b>Details</b>	
No spindle rotation speed command has been issued.	
<b>Remedy</b>	
<ul style="list-style-type: none"> <li>♦Correct the program.</li> </ul>	
<b>P133</b>	<b>Illegal P-No. G96</b>
<b>Details</b>	
The illegal No. was specified for the constant surface speed control axis.	
<b>Remedy</b>	
<ul style="list-style-type: none"> <li>♦Correct the parameter settings and program that specify the constant surface speed control axis.</li> </ul>	
<b>P134</b>	<b>G96 Clamp Err.</b>
<b>Details</b>	
The constant surface speed control command (G96) was issued without commanding the spindle speed clamp (G92/G50).	
<b>Remedy</b>	
Press the reset key and carry out the remedy below.	
<ul style="list-style-type: none"> <li>♦Check the program.</li> <li>♦Issue the G92/G50 command before the G96 command.</li> <li>♦Command the constant surface speed cancel (G97) to switch to the rotation speed command.</li> </ul>	
<b>P140</b>	<b>No spec: Pos compen cmd</b>
<b>Details</b>	
The position compensation command (G45 to G48) is out of specifications.	
<b>Remedy</b>	
<ul style="list-style-type: none"> <li>♦Check the specifications.</li> </ul>	
<b>P141</b>	<b>Pos compen during rotation</b>
<b>Details</b>	
Position compensation was commanded during the figure rotation or coordinate rotation command.	
<b>Remedy</b>	
<ul style="list-style-type: none"> <li>♦Correct the program.</li> </ul>	
<b>P142</b>	<b>Pos compen invalid arc</b>
<b>Details</b>	
Position compensation cannot be executed with the issued arc command.	
<b>Remedy</b>	
<ul style="list-style-type: none"> <li>♦Correct the program.</li> </ul>	
<b>P150</b>	<b>No spec: Nose R compensation</b>
<b>Details</b>	
<ul style="list-style-type: none"> <li>♦Tool radius compensation commands (G41 and G42) were issued though they are out of specifications.</li> <li>♦Nose R compensation commands (G41, G42, and G46) were issued though they are out of specifications.</li> </ul>	
<b>Remedy</b>	
<ul style="list-style-type: none"> <li>♦Check the specifications.</li> </ul>	

<b>P151</b>	<b>Radius compen during arc mode</b>
<b>Details</b>	
A compensation command (G40, G41, G42, G43, G44, or G46) has been issued in the arc modal (G02 or G03).	
<b>Remedy</b>	
<ul style="list-style-type: none"> <li>• Issue the linear command (G01) or rapid traverse command (G00) in the compensation command block or cancel block.</li> <li>(Set the modal to linear interpolation.)</li> </ul>	
<b>P152</b>	<b>No intersection</b>
<b>Details</b>	
<ul style="list-style-type: none"> <li>• In interference block processing during execution of a tool radius compensation (G41 or G42) or nose R compensation (G41, G42, or G46) command, the intersection point after one block is skipped cannot be determined.</li> <li>• The 3-dimensional tool radius compensation value (tool vertical direction compensation) (G41.2 or G42.2) cannot be determined.</li> </ul>	
<b>Remedy</b>	
<ul style="list-style-type: none"> <li>• Correct the program.</li> </ul>	
<b>P153</b>	<b>Compensation interference</b>
<b>Details</b>	
An interference error has occurred while the tool radius compensation command (G41 or G42) or nose R compensation command (G41, G42 or G46) was being executed.	
<b>Remedy</b>	
<ul style="list-style-type: none"> <li>• Correct the program.</li> </ul>	
<b>P154</b>	<b>No spec: 3D compensation</b>
<b>Details</b>	
A three-dimensional compensation command was issued though it is out of specifications.	
<b>Remedy</b>	
<ul style="list-style-type: none"> <li>• Check the specifications.</li> </ul>	
<b>P155</b>	<b>Fixed cyc exec during compen</b>
<b>Details</b>	
A fixed cycle command has been issued in the radius compensation mode.	
<b>Remedy</b>	
<ul style="list-style-type: none"> <li>• Issue a radius compensation cancel command (G40) to cancel the radius compensation mode that has been applied since the fixed cycle command was issued.</li> </ul>	
<b>P156</b>	<b>R compen direction not defined</b>
<b>Details</b>	
A shift vector with undefined compensation direction was found at the start of G46 nose R compensation.	
<b>Remedy</b>	
<ul style="list-style-type: none"> <li>• Change the vector to that which has the defined compensation direction.</li> <li>• Change the tool to that which has a different tip point No.</li> </ul>	
<b>P157</b>	<b>R compen direction changed</b>
<b>Details</b>	
During G46 nose R compensation, the compensation direction is reversed.	
<b>Remedy</b>	
<ul style="list-style-type: none"> <li>• Change the G command to that which allows the reversed compensation direction (G00, G28, G30, G33, or G53).</li> <li>• Change the tool to that which has a different tip point No.</li> <li>• Enable "#8106 G46 NO REV-ERR".</li> </ul>	

<b>P158</b>	<b>Illegal tip point</b>
<b>Details</b>	
An illegal tip point No. (other than 1 to 8) was found during G46 nose R compensation.	
<b>Remedy</b>	
•Correct the tip point No.	
<b>P161</b>	<b>No spec: 3D tool R comp</b>
<b>Details</b>	
3-dimensional tool radius compensation (tool vertical direction compensation) is not included in the specifications.	
<b>Remedy</b>	
•Check the specifications.	
<b>P162</b>	<b>Disable Cmd in 3D tool R comp</b>
<b>Details</b>	
A command (G or T command, etc.) was issued during 3-dimensional tool radius compensation (tool vertical direction compensation), although it is disabled during the compensation.	
<b>Remedy</b>	
•Cancel 3-dimensional tool radius compensation (tool vertical direction compensation).	
<b>P163</b>	<b>3D tool R comp is disabled</b>
<b>Details</b>	
3-dimensional tool radius compensation (tool vertical direction compensation) was commanded in a mode where the command is disabled.	
<b>Remedy</b>	
•Cancel the mode that disables the command.	
<b>P170</b>	<b>No offset number</b>
<b>Details</b>	
•No compensation No. (DOO, TOO or HOO) command was given when the radius compensation (G41, G42, G43 or G46) command was issued. Otherwise, the compensation No. is larger than the number of sets in the specifications.	
•H99 or D99 is commanded with the parameter "#1227 aux11/bit1" enabled when the length compensation method and radius compensation method are set to "1" or "2" for the M system tool life management II.	
<b>Remedy</b>	
•Add the compensation No. command to the compensation command block.	
•Check the number of sets for the tool compensation Nos. and correct the compensation No. command to be within the number of sets.	
•H99 and D99 commands cannot be used when the length compensation method and radius compensation are set to "1" or "2". Set the length compensation method and radius compensation method to "0".	
<b>P171</b>	<b>No spec:Comp input by prog G10</b>
<b>Details</b>	
Compensation data input by program (G10) was commanded though it is out of specifications.	
<b>Remedy</b>	
•Check the specifications.	
<b>P172</b>	<b>G10 L number error</b>
<b>Details</b>	
An address of G10 command is not correct.	
<b>Remedy</b>	
•Correct the address L No. of the G10 command.	

<b>P173</b>	<b>G10 P number error</b>
<b>Details</b>	
The compensation No. at the G10 command is not within the permitted number of sets in the specifications.	
<b>Remedy</b>	
•Check the number of sets for the tool compensation Nos. and correct the address P designation to be within the number of sets.	
<b>P174</b>	<b>No spec:Comp input by prog G11</b>
<b>Details</b>	
Compensation data input by program cancel (G11) was commanded though there is no specification of compensation data input by program.	
<b>Remedy</b>	
•Check the specifications.	
<b>P177</b>	<b>Tool life count active</b>
<b>Details</b>	
Registration of tool life management data with G10 was attempted when the "usage data count valid" signal was ON.	
<b>Remedy</b>	
•The tool life management data cannot be registered during the usage data count. Turn the "usage data count valid" signal OFF.	
<b>P178</b>	<b>Tool life data entry over</b>
<b>Details</b>	
The number of registration groups, total number of registered tools or the number of registrations per group exceeded the range in the specifications.	
<b>Remedy</b>	
•Correct the number of registrations.	
<b>P179</b>	<b>Illegal group No.</b>
<b>Details</b>	
•A duplicate group No. was found at the registration of the tool life management data with G10.	
•A group No. that was not registered was designated during the T****99 command.	
•An M code command, which must be issued as a single command, coexists in the same block as that of another M code command.	
•The M code commands set in the same group exist in the same block.	
<b>Remedy</b>	
•Register the estimated tool life data/cumulative usage data once for one group: commanding with a duplicate group No. is not allowed.	
•Correct to the group No.	
<b>P180</b>	<b>No spec: Drilling cycle</b>
<b>Details</b>	
A fixed cycle command (G72 - G89) was issued though it is out of specifications.	
<b>Remedy</b>	
•Check the specifications.	
•Correct the program.	
<b>P181</b>	<b>No spindle command (Tap cycle)</b>
<b>Details</b>	
Spindle rotation speed (S) has not been commanded in synchronous tapping.	
<b>Remedy</b>	
•Command the spindle rotation speed (S) in synchronous tapping.	
•When "#8125 Check Scode in G84" is set to "1", enter the S command in the same block where the synchronous tapping command is issued.	

<b>P182</b>	<b>Synchronous tap error</b>
<b>Details</b>	
<ul style="list-style-type: none"> <li>♦Connection to the main spindle unit was not established.</li> <li>♦The synchronous tapping was attempted with the spindle not serially connected under the multiple-spindle control I.</li> <li>♦Synchronous tapping command was given to the analog spindle while analog spindle synchronous tapping was unavailable.</li> </ul>	
<b>Remedy</b>	
<ul style="list-style-type: none"> <li>♦Check connection to the main spindle.</li> <li>♦Check that the main spindle encoder exists.</li> <li>♦Set 1 to the parameter #3024 (sout).</li> <li>♦Correct the program.</li> </ul>	
<b>P183</b>	<b>No pitch/thread number</b>
<b>Details</b>	
The pitch or number of threads has not been commanded in the tap cycle of a fixed cycle for drilling command.	
<b>Remedy</b>	
<ul style="list-style-type: none"> <li>♦Specify the pitch data and the number of threads by F or E command.</li> </ul>	
<b>P184</b>	<b>Pitch/thread number error</b>
<b>Details</b>	
<ul style="list-style-type: none"> <li>♦The pitch or the number of threads per inch is illegal in the tap cycle of the fixed cycle for drilling command.</li> <li>♦The pitch is too small for the spindle rotation speed.</li> <li>♦The thread number is too large for the spindle rotation speed.</li> </ul>	
<b>Remedy</b>	
<ul style="list-style-type: none"> <li>♦Correct the pitch or the number of threads per inch.</li> </ul>	
<b>P185</b>	<b>No spec: Sync tapping cycle</b>
<b>Details</b>	
Synchronous tapping cycle (G84/G74) was commanded though it is out of specifications.	
<b>Remedy</b>	
<ul style="list-style-type: none"> <li>♦Check the specifications.</li> </ul>	
<b>P186</b>	<b>Illegal S cmdnd in synchro tap</b>
<b>Details</b>	
S command was issued during synchronous tapping modal.	
<b>Remedy</b>	
<ul style="list-style-type: none"> <li>♦Cancel the synchronous tapping before issuing the S command.</li> </ul>	
<b>P190</b>	<b>No spec: Turning cycle</b>
<b>Details</b>	
A lathe cutting cycle command was issued though it is out of specifications.	
<b>Remedy</b>	
<ul style="list-style-type: none"> <li>♦Check the specification.</li> <li>♦Delete the lathe cutting cycle command.</li> </ul>	
<b>P191</b>	<b>Taper length error</b>
<b>Details</b>	
In the lathe cutting cycle, the specified length of taper section is illegal.	
<b>Remedy</b>	
<ul style="list-style-type: none"> <li>♦Set the smaller radius value than the axis travel amount in the lathe cycle command.</li> </ul>	
<b>P192</b>	<b>Chamfering error</b>
<b>Details</b>	
Chamfering in the thread cutting cycle is illegal.	
<b>Remedy</b>	
<ul style="list-style-type: none"> <li>♦Set a chamfering amount not exceeding the cycle.</li> </ul>	

<b>P199</b>	<b>Tool selection is incorrect</b>
<b>Details</b>	
A turning tool shape compensation was commanded while a tool other than turning tool has been selected.	
<b>Remedy</b>	
•Select "Lathing" for tool type in tool management data before giving the turning tool shape compensation command.	
<b>P200</b>	<b>No spec: MRC cycle</b>
<b>Details</b>	
The compound type fixed cycle for turning machining I (G70 to G73) was commanded though it is out of specifications.	
<b>Remedy</b>	
•Check the specifications.	
<b>P201</b>	<b>Program error (MRC)</b>
<b>Details</b>	
•The subprogram, called with a compound type fixed cycle for turning machining I command, has at least one of the following commands: reference position return command (G27, G28, G29, G30); thread cutting (G33, G34); fixed cycle skip-function (G31, G31.n).	
•An arc command was found in the first movement block of the finished shape program in compound type fixed cycle for turning machining I.	
<b>Remedy</b>	
•Delete G27, G28, G29, G30, G31, G33, G34, and fixed cycle G codes from the subprogram called with the compound type fixed cycle for turning machining I commands (G70 to G73).	
•Delete G02 and G03 from the first movement block of the finished shape program in compound type fixed cycle for turning machining I.	
<b>P202</b>	<b>Block over (MRC)</b>
<b>Details</b>	
The number of blocks in the shape program of the compound type fixed cycle for turning machining I is over 50 or 200 (the maximum number differs according to the model).	
<b>Remedy</b>	
•Set a 50/200 or less value for the number of blocks in the shape program called by the compound type fixed cycle for turning machining I commands (G70 to G73). (The maximum number differs according to the model).	
<b>P203</b>	<b>D cmdnd figure error (MRC)</b>
<b>Details</b>	
A proper shape will not obtained by executing the shape program for the compound type fixed cycle for turning machining I (G70 to G73).	
<b>Remedy</b>	
•Correct the shape program for the compound type fixed cycle for turning machining I (G70 to G73).	
<b>P204</b>	<b>E cmdnd fixed cycle error</b>
<b>Details</b>	
A command value of the compound type fixed cycle for turning machining (G70 to G76) is illegal.	
<b>Remedy</b>	
•Correct the command value of the compound type fixed cycle for turning machining (G70 to G76).	
<b>P210</b>	<b>No spec: Pattern cycle</b>
<b>Details</b>	
A compound type fixed cycle for turning machining II (G74 to G76) command was commanded though it is out of specifications.	
<b>Remedy</b>	
•Check the specifications.	

<b>P220</b>	<b>No spec: Special fixed cycle</b>
<b>Details</b>	
There are no special fixed cycle specifications.	
<b>Remedy</b>	
♦Check the specifications.	
<b>P221</b>	<b>No. of special fixed holes = 0</b>
<b>Details</b>	
"0" has been specified for the number of holes in special fixed cycle mode.	
<b>Remedy</b>	
♦Correct the program.	
<b>P222</b>	<b>G36 angle error</b>
<b>Details</b>	
A G36 command specifies "0" for angle intervals.	
<b>Remedy</b>	
♦Correct the program.	
<b>P223</b>	<b>G12/G13 radius error</b>
<b>Details</b>	
The radius value specified with a G12 or G13 command is below the compensation amount.	
<b>Remedy</b>	
♦Correct the program.	
<b>P224</b>	<b>No spec: Circular (G12/G13)</b>
<b>Details</b>	
There are no circular cutting specifications.	
<b>Remedy</b>	
♦Check the specifications.	
<b>P230</b>	<b>Subprogram nesting over</b>
<b>Details</b>	
Over 10 times of subprogram calls have been done in succession from a subprogram.	
♦A M198 command was found in the program in the data server.	
<b>Remedy</b>	
♦Correct the program so that the number of subprogram calls does not exceed 10 times.	
<b>P231</b>	<b>No sequence No.</b>
<b>Details</b>	
The sequence No., commanded at the return from the subprogram or by GOTO in the subprogram call, was not set.	
<b>Remedy</b>	
♦Specify the sequence Nos. in the call block of the subprogram.	
<b>P232</b>	<b>No program No.</b>
<b>Details</b>	
♦The machining program has not been found when the machining program is called.	
<b>Remedy</b>	
♦Enter the machining program.	
♦Check the subprogram storage destination parameters.	
♦Ensure that the external device (including SD card/USB memory) that contains the file is mounted.	



<b>P235</b>	<b>Program editing</b>
<b>Details</b>	
Operation was attempted for the file under program editing.	
<b>Remedy</b>	
•Execute the program again after completion of program editing.	
<b>P240</b>	<b>No spec: Variable commands</b>
<b>Details</b>	
A variable command (with #) was issued though it is out of specifications.	
<b>Remedy</b>	
•Check the specifications.	
<b>P241</b>	<b>No variable No.</b>
<b>Details</b>	
The variable No. commanded is out of the range specified in the specifications.	
<b>Remedy</b>	
•Check the specifications.	
•Correct the program variable No.	
<b>P242</b>	<b>= not defined at vrble set</b>
<b>Details</b>	
The "=" sign has not been commanded when a variable is defined.	
<b>Remedy</b>	
•Designate the "=" sign in the variable definition of the program.	
<b>P243</b>	<b>Can't use variables</b>
<b>Details</b>	
•An invalid variable has been specified in the left or right side of an operation expression.	
•Assignment to a write-protected variable has been commanded.	
<b>Remedy</b>	
•Correct the program.	
<b>P244</b>	<b>Invalid set date or time</b>
<b>Details</b>	
Date or time was set earlier than current date or time in the system variables (#3011, #3012) when the system lock was valid.	
<b>Remedy</b>	
•Date or time cannot be changed.	
•Correct the program.	
<b>P245</b>	<b>Tool No. error</b>
<b>Details</b>	
•Tool data read/write command has been executed without selecting the tool command method.	
•Tool command method (#68000) or tool selection No. (#68001) is incorrect.	
(1) The tool specified as "Tool in use" is not installed.	
(2) Any unregistered tool No. has been designated.	
(3) Tool selection No. (#68001) has not been designated.	
•Write of "Tool No." has been commanded using #68001 while tool No. is being designated.	
•Write of "Tool No." has been commanded for an already registered tool No.	
<b>Remedy</b>	
•Check the program to make sure that the tool command method (#68000) and tool selection No. (#68001) are correct.	
•Make sure, if you wish to designate a tool in use, that the said tool No. is nonzero and is already registered on the tool management screen.	
•Make sure, if you wish to designate a tool No., that the tool No. registered on the tool management screen has been commanded using #68001.	
•#68001 is unable to write the same tool No. as that already registered on the tool management screen.	

<b>P250</b>	<b>No spec: Figure rotation</b>
<b>Details</b>	
Figure rotation (M98 I_J_P_H_L_) was commanded though it is out of specifications.	
<b>Remedy</b>	
♦Check the specifications.	
<b>P251</b>	<b>Figure rotation overlapped</b>
<b>Details</b>	
Figure rotation command was issued during figure rotation.	
<b>Remedy</b>	
♦Correct the program.	
<b>P252</b>	<b>Coord rotate in fig. rotation</b>
<b>Details</b>	
A coordinate rotation related command (G68, G69) was issued during figure rotation.	
<b>Remedy</b>	
♦Correct the program.	
<b>P260</b>	<b>No spec: Coordinates rotation</b>
<b>Details</b>	
A coordinate rotation command was issued though it is out of specifications.	
<b>Remedy</b>	
♦Check the specifications.	
<b>P261</b>	<b>G code illegal (Coord rot)</b>
<b>Details</b>	
Another G code or a T command has been issued in the block of coordinate rotation command.	
<b>Remedy</b>	
♦Correct the program.	
<b>P262</b>	<b>Illegal modal (Coord rot)</b>
<b>Details</b>	
A coordinate rotation command has been issued during modal in which coordinate rotation is not allowed.	
<b>Remedy</b>	
♦Correct the program.	
<b>P270</b>	<b>No spec: User macro</b>
<b>Details</b>	
A macro specification was commanded though it is out of specifications.	
<b>Remedy</b>	
♦Check the specifications.	
<b>P271</b>	<b>No spec: Macro interrupt</b>
<b>Details</b>	
A macro interruption command has been issued though it is out of specifications.	
<b>Remedy</b>	
♦Check the specifications.	
<b>P272</b>	<b>NC and macro texts in a block</b>
<b>Details</b>	
An executable statement and a macro statement exist together in the same block.	
<b>Remedy</b>	
♦Place the executable statement and macro statement in separate blocks in the program.	

<b>P273</b>	<b>Macro call nesting over</b>
<b>Details</b>	
The number of macro call nests exceeded the limit imposed by the specifications.	
<b>Remedy</b>	
•Correct the program so that the macro calls do not exceed the limit imposed by the specifications.	
<b>P275</b>	<b>Macro argument over</b>
<b>Details</b>	
The number of argument sets in the macro call argument type II has exceeded the limit.	
<b>Remedy</b>	
•Correct the program.	
<b>P276</b>	<b>Illegal G67 command</b>
<b>Details</b>	
A G67 command was issued though it was not during the G66 command modal.	
<b>Remedy</b>	
•Correct the program.	
•Issue G66 command before G67 command, which is a call cancel command.	
<b>P277</b>	<b>Macro alarm message</b>
<b>Details</b>	
An alarm command has been issued in #3000.	
<b>Remedy</b>	
•Refer to the operator messages on the diagnosis screen.	
•Refer to the instruction manual issued by the machine tool builder.	
<b>P280</b>	<b>Brackets [ ] nesting over</b>
<b>Details</b>	
Over five times have the parentheses "[" or "]" been used in a single block.	
<b>Remedy</b>	
•Correct the program so that the number of "[" or "]" is five or less.	
<b>P281</b>	<b>Brackets [ ] not paired</b>
<b>Details</b>	
A single block does not have the same number of commanded parentheses "[" as that of "]".	
<b>Remedy</b>	
•Correct the program so that "[" and "]" parentheses are paired up properly.	
<b>P282</b>	<b>Calculation impossible</b>
<b>Details</b>	
The arithmetic formula is incorrect.	
<b>Remedy</b>	
•Correct the formula in the program.	
<b>P283</b>	<b>Divided by zero</b>
<b>Details</b>	
The denominator of the division is zero.	
<b>Remedy</b>	
•Correct the program so that the denominator for division in the formula is not zero.	
<b>P288</b>	<b>IF EXCESS</b>
<b>Details</b>	
The multiplicity of the IF statement exceeded 10 times.	
<b>Remedy</b>	
•The program is reviewed so that the multiplicity of the IF statement does not exceed 10 times.	

<b>P289</b>	<b>IF-ENDIF MMC.</b>
	<p><b>Details</b></p> <p>IF and ENDIF are not in pairs. THEN/ELSE is ordered in the absence of IF command.</p> <p><b>Remedy</b></p> <ul style="list-style-type: none"> <li>♦The program is reviewed so that IF and ENDIF become pairs.</li> <li>♦Before THEN/ELSE command, IF[&lt;conditional&gt;]command is given.</li> </ul>
<b>P290</b>	<b>IF sentence error</b>
	<p><b>Details</b></p> <p>There is an error in the "IF[&lt;conditional&gt;]GOTO(" statement.</p> <p><b>Remedy</b></p> <ul style="list-style-type: none"> <li>♦Correct the program.</li> </ul>
<b>P291</b>	<b>WHILE sentence error</b>
	<p><b>Details</b></p> <p>There is an error in the "WHILE[&lt;conditional&gt;]DO(-END(" statement.</p> <p><b>Remedy</b></p> <ul style="list-style-type: none"> <li>♦Correct the program.</li> </ul>
<b>P292</b>	<b>SETVN sentence error</b>
	<p><b>Details</b></p> <p>There is an error in the "SETVN(" statement when the variable name setting was made.</p> <p><b>Remedy</b></p> <ul style="list-style-type: none"> <li>♦Correct the program.</li> <li>♦The number of characters in the variable name of the SETVN statement must be 7 or less.</li> </ul>
<b>P293</b>	<b>DO-END nesting over</b>
	<p><b>Details</b></p> <p>The number of DO-END nesting levels in the "WHILE[&lt;conditional&gt;]DO(-END(" statement has exceeded 27.</p> <p><b>Remedy</b></p> <ul style="list-style-type: none"> <li>♦Correct the program so that the nesting levels of the DO-END statement does not exceed 27.</li> </ul>
<b>P294</b>	<b>DO and END not paired</b>
	<p><b>Details</b></p> <p>The DOs and ENDS are not paired off properly.</p> <p><b>Remedy</b></p> <ul style="list-style-type: none"> <li>♦Correct the program so that the DOs and ENDS are paired off properly.</li> </ul>
<b>P295</b>	<b>WHILE/GOTO in tape</b>
	<p><b>Details</b></p> <p>There is a WHILE or GOTO statement on the tape during tape operation.</p> <p><b>Remedy</b></p> <ul style="list-style-type: none"> <li>♦Apply memory mode operation instead of tape mode that does not allow the execution of the program with a WHILE or GOTO statement.</li> </ul>
<b>P296</b>	<b>No address (macro)</b>
	<p><b>Details</b></p> <p>A required address has not been specified in the user macro.</p> <p><b>Remedy</b></p> <ul style="list-style-type: none"> <li>♦Correct the program.</li> </ul>

<b>P297</b>	<b>Address-A error</b>
	<p><b>Details</b></p> <p>The user macro does not use address A as a variable.</p> <p><b>Remedy</b></p> <ul style="list-style-type: none"> <li>•Correct the program.</li> </ul>
<b>P298</b>	<b>G200-G202 cmnd in tape</b>
	<p><b>Details</b></p> <p>User macro G200, G201, or G202 was specified during tape or MDI mode.</p> <p><b>Remedy</b></p> <ul style="list-style-type: none"> <li>•Correct the program.</li> </ul>
<b>P300</b>	<b>Variable name illegal</b>
	<p><b>Details</b></p> <p>The variable names have not been commanded properly.</p> <p><b>Remedy</b></p> <ul style="list-style-type: none"> <li>•Correct the variable names in the program.</li> </ul>
<b>P301</b>	<b>Variable name duplicated</b>
	<p><b>Details</b></p> <p>A duplicate variable name was found.</p> <p><b>Remedy</b></p> <ul style="list-style-type: none"> <li>•Correct the program so that no duplicate name exists.</li> </ul>
<b>P310</b>	<b>Not use GMSTB macro code</b>
	<p><b>Details</b></p> <p>G, M, S, T, or B macro code was called during fixed cycle.</p> <p><b>Remedy</b></p> <ul style="list-style-type: none"> <li>•Correct the program.</li> <li>•Correct the parameter settings.</li> </ul>
<b>P350</b>	<b>No spec: Scaling command</b>
	<p><b>Details</b></p> <p>The scaling command (G50, G51) was issued though it is out of specifications.</p> <p><b>Remedy</b></p> <ul style="list-style-type: none"> <li>•Check the specifications.</li> </ul>
<b>P360</b>	<b>No spec: Program mirror</b>
	<p><b>Details</b></p> <p>A mirror image (G50.1 or G51.1) command has been issued though the programmable mirror image specifications are not provided.</p> <p><b>Remedy</b></p> <ul style="list-style-type: none"> <li>•Check the specifications.</li> </ul>
<b>P370</b>	<b>No spec: Facing t-post MR</b>
	<p><b>Details</b></p> <p>The facing turret mirror image specifications are not provided.</p> <p><b>Remedy</b></p> <ul style="list-style-type: none"> <li>•Check the specifications.</li> </ul>

<b>P371</b>	<b>Facing t-post MR illegal</b>
<b>Details</b>	
<ul style="list-style-type: none"> <li>♦Mirror image for facing tool posts was commanded to an axis in external mirror image or parameter mirror image.</li> <li>♦The commanded mirror image for facing tool posts enables the mirror image for a rotary axis.</li> </ul>	
<b>Remedy</b>	
<ul style="list-style-type: none"> <li>♦Correct the program.</li> <li>♦Correct the parameter settings.</li> </ul>	
<b>P380</b>	<b>No spec: Corner R/C</b>
<b>Details</b>	
The corner R/C was issued though it is out of specifications.	
<b>Remedy</b>	
<ul style="list-style-type: none"> <li>♦Check the specifications.</li> <li>♦Delete the corner chamfering/corner rounding command in the program.</li> </ul>	
<b>P381</b>	<b>No spec: Arc R/C</b>
<b>Details</b>	
Corner chamfering II or corner rounding II was commanded in the arc interpolation block though it is out of specifications.	
<b>Remedy</b>	
<ul style="list-style-type: none"> <li>♦Check the specifications.</li> </ul>	
<b>P382</b>	<b>No corner movement</b>
<b>Details</b>	
The block next to corner chamfering/ corner rounding is not a travel command.	
<b>Remedy</b>	
<ul style="list-style-type: none"> <li>♦Replace the block succeeding the corner chamfering/ corner rounding command by G01 command.</li> </ul>	
<b>P383</b>	<b>Corner movement short</b>
<b>Details</b>	
The travel distance in the corner chamfering/corner rounding command was shorter than the value in the corner chamfering/corner rounding command.	
<b>Remedy</b>	
<ul style="list-style-type: none"> <li>♦Set the smaller value for the corner chamfering/corner rounding than the travel distance.</li> </ul>	
<b>P384</b>	<b>Corner next movement short</b>
<b>Details</b>	
The travel distance in the following block in the corner chamfering/corner rounding command was shorter than the value in the corner chamfering/corner rounding command.	
<b>Remedy</b>	
<ul style="list-style-type: none"> <li>♦Set the smaller value for the corner chamfering/corner rounding than the travel distance in the following block.</li> </ul>	
<b>P385</b>	<b>Corner during G00/G33</b>
<b>Details</b>	
A block with corner chamfering/corner rounding was given during G00 or G33 modal.	
<b>Remedy</b>	
<ul style="list-style-type: none"> <li>♦Correct the program.</li> </ul>	
<b>P390</b>	<b>No spec: Geometric</b>
<b>Details</b>	
A geometric command was issued though it is out of specifications.	
<b>Remedy</b>	
<ul style="list-style-type: none"> <li>♦Check the specifications.</li> </ul>	

<b>P391</b>	<b>No spec: Geometric arc</b>
	<b>Details</b> There are no geometric IB specifications.
	<b>Remedy</b> •Check the specifications.
<b>P392</b>	<b>Angle &lt; 1 degree (GEOMT)</b>
	<b>Details</b> The angular difference between the geometric line and line is 1° or less.
	<b>Remedy</b> •Correct the geometric angle.
<b>P393</b>	<b>Inc value in 2nd block (GEOMT)</b>
	<b>Details</b> The second geometric block has a command with an incremental value.
	<b>Remedy</b> •Issue a command with an absolute value in the second geometric block.
<b>P394</b>	<b>No linear move command (GEOMT)</b>
	<b>Details</b> The second geometric block contains no linear command.
	<b>Remedy</b> •Issue the G01 command.
<b>P395</b>	<b>Illegal address (GEOMT)</b>
	<b>Details</b> The geometric format is invalid.
	<b>Remedy</b> •Correct the program.
<b>P396</b>	<b>Plane selected in GEOMT ctrl</b>
	<b>Details</b> A plane switching command was issued during geometric command processing.
	<b>Remedy</b> •Complete the plane switching command before geometric command processing.
<b>P397</b>	<b>Arc error (GEOMT)</b>
	<b>Details</b> In geometric IB, the arc end point does not contact or intersect the start point of the next block.
	<b>Remedy</b> •Correct the first and second commands containing a circular arc command for geometric.
<b>P398</b>	<b>No spec: Geometric1B</b>
	<b>Details</b> A geometric command was issued though the geometric IB specifications are not provided.
	<b>Remedy</b> •Check the specifications.

<b>P411</b>	<b>Illegal modal G111</b>
<b>Details</b>	
<ul style="list-style-type: none"> <li>♦G111 was issued during milling mode.</li> <li>♦G111 was issued during nose R compensation mode.</li> <li>♦G111 was issued during constant surface speed.</li> <li>♦G111 was issued during mixed control (cross axis control).</li> <li>♦G111 was issued during fixed cycle.</li> <li>♦G111 was issued during polar coordinate interpolation.</li> <li>♦G111 was issued during cylindrical interpolation mode.</li> </ul>	
<b>Remedy</b>	
<ul style="list-style-type: none"> <li>♦Before commanding G111, cancel the following commands.</li> <li>♦Milling mode</li> <li>♦Nose R compensation</li> <li>♦Constant surface speed</li> <li>♦Mixed control (cross axis control)</li> <li>♦Fixed cycle</li> <li>♦Polar coordinate interpolation</li> <li>♦Cylindrical interpolation</li> </ul>	
<b>P412</b>	<b>No spec: Axis name switch</b>
<b>Details</b>	
Axis name switch (G111) was issued though it is out of specifications.	
<b>Remedy</b>	
<ul style="list-style-type: none"> <li>♦Check the specifications.</li> </ul>	
<b>P420</b>	<b>No spec: Para input by program</b>
<b>Details</b>	
Parameter input by program (G10) was commanded though it is out of specifications.	
<b>Remedy</b>	
<ul style="list-style-type: none"> <li>♦Check the specifications.</li> </ul>	
<b>P421</b>	<b>Parameter input error</b>
<b>Details</b>	
<ul style="list-style-type: none"> <li>♦The specified parameter No. or set data is illegal.</li> <li>♦An illegal G command address was input in parameter input mode.</li> <li>♦A parameter input command was issued during fixed cycle modal or nose R compensation.</li> <li>♦G10L50, G10L70, G10L100, G11 were not commanded in independent blocks.</li> </ul>	
<b>Remedy</b>	
<ul style="list-style-type: none"> <li>♦Correct the program.</li> </ul>	
<b>P422</b>	<b>Tool/Work shape input error</b>
<b>Details</b>	
<ul style="list-style-type: none"> <li>♦G10 L100, G10 L101 or G11 has been given together with any other command in a block.</li> <li>♦Address P or T has been omitted from G10 L100.</li> <li>♦Address C has been omitted from G10 L101.</li> </ul>	
<b>Remedy</b>	
<ul style="list-style-type: none"> <li>♦Correct the program.</li> </ul>	



<b>P423</b>	<b>R-Navi input error</b>
<b>Details</b>	
<ul style="list-style-type: none"> <li>♦G10 L110, G10 L111 or G11 has been given together with any other command in a block.</li> <li>♦Address Q has been omitted from G10 L110.</li> <li>♦Address P, Q or D has been omitted from G10 L111.</li> <li>♦Machining surface parameter input command has been issued for an undefined workpiece.</li> <li>♦An index angle command has been given to any axis other than Z when using the coordinate axis direction setting method.</li> <li>♦Neither the workpiece registration No. nor surface registration No. has been selected when setting a machining surface.</li> </ul>	
<b>Remedy</b>	
<ul style="list-style-type: none"> <li>♦Correct the program.</li> <li>♦Correct the setting of workpiece to machine.</li> </ul>	
<b>P430</b>	<b>R-pnt return incomplete</b>
<b>Details</b>	
<ul style="list-style-type: none"> <li>♦A command was issued to move an axis, which has not returned to the reference position, away from that reference position.</li> <li>♦A command was issued to an axis removal axis.</li> </ul>	
<b>Remedy</b>	
<ul style="list-style-type: none"> <li>♦Execute reference position return manually.</li> <li>♦Disable the axis removal on the axis for which the command was issued.</li> </ul>	
<b>P431</b>	<b>No spec: 2,3,4th R-point ret</b>
<b>Details</b>	
A command for second, third or fourth reference position return was issued though there are no such command specifications.	
<b>Remedy</b>	
<ul style="list-style-type: none"> <li>♦Check the specifications.</li> </ul>	
<b>P432</b>	<b>No spec: Start position return</b>
<b>Details</b>	
Start position return (G29) was commanded though it is out of specifications.	
<b>Remedy</b>	
<ul style="list-style-type: none"> <li>♦Check the specifications.</li> </ul>	
<b>P433</b>	<b>No spec: R-position check</b>
<b>Details</b>	
Reference position check (G27) was commanded though it is out of specifications.	
<b>Remedy</b>	
<ul style="list-style-type: none"> <li>♦Check the specifications.</li> </ul>	
<b>P434</b>	<b>Compare error</b>
<b>Details</b>	
One of the axes did not return to the reference position when the reference position check command (G27) was executed.	
<b>Remedy</b>	
<ul style="list-style-type: none"> <li>♦Correct the program.</li> </ul>	
<b>P435</b>	<b>G27 and M commands in a block</b>
<b>Details</b>	
An M command was issued simultaneously in the G27 command block.	
<b>Remedy</b>	
<ul style="list-style-type: none"> <li>♦Place the M code command, which cannot be issued in a G27 command block, in separate block from G27 command block.</li> </ul>	

<b>P436</b>	<b>G29 and M commands in a block</b>
<b>Details</b>	
An M command was issued simultaneously in the G29 command block.	
<b>Remedy</b>	
♦Place the M code command, which cannot be issued in a G29 command block, in separate block from G29 command block.	
<b>P438</b>	<b>G52 invalid during G54.1</b>
<b>Details</b>	
A local coordinate system command was issued during execution of the G54.1 command.	
<b>Remedy</b>	
♦Correct the program.	
<b>P450</b>	<b>No spec: Chuck barrier</b>
<b>Details</b>	
The chuck barrier on command (G22) was specified although the chuck barrier is out of specifications.	
<b>Remedy</b>	
♦Check the specifications.	
<b>P451</b>	<b>No spec: Stroke chk bef travel</b>
<b>Details</b>	
Stroke check before travel (G22/G23) was commanded though it is out of specifications.	
<b>Remedy</b>	
♦Check the specifications.	
<b>P452</b>	<b>Limit before travel exists</b>
<b>Details</b>	
An illegal command, which places the axis travel start/end point in the prohibited area or moves the axis through the prohibited area, was detected when Stroke check before travel (G22) was commanded.	
<b>Remedy</b>	
♦Correct the coordinate values of the axis address commanded in the program.	
<b>P460</b>	<b>Tape I/O error</b>
<b>Details</b>	
An error has occurred in the tape reader. Otherwise an error has occurred in the printer during macro printing.	
<b>Remedy</b>	
♦Check the power and cable of the connected devices.	
♦Correct the I/O device parameters.	
<b>P461</b>	<b>File I/O error</b>
<b>Details</b>	
♦A file of the machining program cannot be read.	
<b>Remedy</b>	
♦In memory mode, the programs stored in memory may have been destroyed. Output all of the programs and tool data and then format the system.	
♦Ensure that the external device (including SD card/USB memory) that contains the file is mounted.	
♦Correct the parameter settings for HD operation, SD card operation or USB memory operation.	
<b>P462</b>	<b>Computer link commu error</b>
<b>Details</b>	
A communication error occurred during the BTR operation.	
<b>Remedy</b>	
♦"L01 Computer link error" is displayed simultaneously. Take the remedy corresponding to the error No.	

---

<b>P480</b>	<b>No spec: Milling</b>
-------------	-------------------------

---

<b>Details</b>
<ul style="list-style-type: none"><li>•Milling was commanded though it is out of specifications.</li><li>•Polar coordinate interpolation was commanded though it is out of specifications.</li></ul>
<b>Remedy</b>
<ul style="list-style-type: none"><li>•Check the specifications.</li></ul>

---

<b>P481</b>	<b>Illegal G code (mill)</b>
-------------	------------------------------

---

<b>Details</b>
<ul style="list-style-type: none"><li>•An illegal G code was used during the milling mode.</li><li>•An illegal G code was used during cylindrical interpolation or polar coordinate interpolation.</li><li>•The G07.1 command was issued during the tool radius compensation.</li></ul>
<b>Remedy</b>
<ul style="list-style-type: none"><li>•Correct the program.</li></ul>

---

<b>P482</b>	<b>Illegal axis (mill)</b>
-------------	----------------------------

---

<b>Details</b>
<ul style="list-style-type: none"><li>•A rotary axis was commanded during the milling mode.</li><li>•Milling was executed though an illegal value was set for the milling axis No.</li><li>•Cylindrical interpolation or polar coordinate interpolation was commanded during mirror image.</li><li>•Cylindrical interpolation or polar coordinate interpolation was commanded before the tool compensation was completed after the T command.</li><li>•G07.1 was commanded when cylindrical interpolation was not possible (there is no rotary axis, or external mirror image is ON).</li><li>•An axis other than a cylindrical coordinate system axis was commanded during cylindrical interpolation.</li></ul>
<b>Remedy</b>
<ul style="list-style-type: none"><li>•Correct the machining program, parameters and PLC interface signals.</li></ul>

---

<b>P484</b>	<b>R-pnt ret incomplete (mill)</b>
-------------	------------------------------------

---

<b>Details</b>
<ul style="list-style-type: none"><li>•Movement was commanded to an axis that had not completed reference position return during the milling mode.</li><li>•Movement was commanded to an axis that had not completed reference position return during cylindrical interpolation or polar coordinate interpolation.</li></ul>
<b>Remedy</b>
<ul style="list-style-type: none"><li>•Carry out manual reference position return.</li></ul>

---

---

**P485**      **Illegal modal (mill)**

---

**Details**

- ♦The milling mode was turned ON during nose R compensation or constant surface speed control.
- ♦A T command was issued during the milling mode.
- ♦The mode was switched from milling to cutting during tool compensation.
- ♦Cylindrical interpolation or polar coordinate interpolation was commanded during the constant surface speed control mode (G96).
- ♦The command unacceptable in the cylindrical interpolation was issued.
- ♦A T command was issued during the cylindrical interpolation or polar coordinate interpolation mode.
- ♦A movement command was issued when the plane was not selected just before or after the G07.1 command.
- ♦A plane selection command was issued during the polar coordinate interpolation mode.
- ♦Cylindrical interpolation or polar coordinate interpolation was commanded during tool radius compensation.
- ♦The G16 plane in which the radius value of a cylinder is "0" was specified.
- ♦A cylindrical interpolation or polar coordinate interpolation command was issued during coordinate rotation by program.

**Remedy**

- ♦Correct the program.
- ♦Issue G40 or G97 before issuing G12.1.
- ♦Issue a T command before issuing G12.1.
- ♦Issue G40 before issuing G13.1.
- ♦Specify the radius value of a cylinder other than "0", or specify the X axis's current value other than "0" before issuing G12.1/G16.

---

**P486**      **Milling error**

---

**Details**

- ♦The milling command was issued during the mirror image (when parameter or external input is turned ON).
- ♦Polar coordinate interpolation, cylindrical interpolation or milling interpolation was commanded during mirror image for facing tool posts.
- ♦The start command of the cylindrical interpolation or polar coordinate interpolation was issued during the normal line control.

**Remedy**

- ♦Correct the program.

<b>P501</b>	<b>Cross (G110) impossible</b>
<b>Details</b>	
Mixed control command (G110), Arbitrary axis exchange command (G140), Arbitrary axis exchange return command (G141) or Base axis configuration restore command (G142) has been given to a part system that is under any of the following state.	
<ul style="list-style-type: none"> <li>•Cylindrical interpolation mode</li> <li>•Polar coordinate interpolation mode</li> <li>•Milling interpolation mode</li> <li>•Constant surface speed control mode</li> <li>•Polygon cut mode</li> <li>•Hob machining mode</li> <li>•Nose R compensation mode</li> <li>•Tool radius compensation mode</li> <li>•During axis name switch</li> <li>•Fixed cycle for drilling</li> <li>•Fixed cycle for lathe turning</li> <li>•Compound-type fixed cycle mode</li> <li>•Special fixed cycle mode</li> <li>•Facing turret mirror image mode</li> <li>•Balance cut mode</li> <li>•Chuck barrier/Tailstock barrier</li> <li>•Stroke check before travel</li> <li>•During Macro modal call (G66.1)</li> <li>•Hypothetical axis interpolation mode</li> <li>•Figure rotation mode</li> <li>•During scaling</li> <li>•Coordinate rotation by parameter mode</li> <li>•Polar coordinate command mode</li> <li>•Normal line control mode</li> <li>•Circular cutting mode</li> <li>•Tool direction tool length compensation mode</li> </ul>	
<b>Remedy</b>	
<ul style="list-style-type: none"> <li>•Correct the program.</li> </ul>	
<b>P503</b>	<b>Illegal G110 axis</b>
<b>Details</b>	
Any of the following commands was given to an axis that is under the following conditions: Mixed control command, Arbitrary axis exchange command, Arbitrary axis exchange return command or Basic axis configuration return command.	
<ul style="list-style-type: none"> <li>•The commanded axis does not exist.</li> <li>•The command caused the maximum number of axes per part system to be exceeded.</li> <li>•The command was given to an axis for which axis exchange is disabled.</li> </ul>	
<b>Remedy</b>	
<ul style="list-style-type: none"> <li>•Correct the program.</li> </ul>	
<b>P511</b>	<b>Synchronization M code error</b>
<b>Details</b>	
<ul style="list-style-type: none"> <li>•Two or more synchronization M codes were commanded in the same block.</li> <li>•The synchronization M code and "!" code were commanded in the same block.</li> <li>•Synchronization with the M code was commanded in 3rd part system or more. (Synchronization with the M code is valid only in 1st part system or 2nd part system.)</li> </ul>	
<b>Remedy</b>	
<ul style="list-style-type: none"> <li>•Correct the program.</li> </ul>	
<b>P520</b>	<b>Control axis superimposition/Designated axis illegal</b>
<b>Details</b>	
<ul style="list-style-type: none"> <li>•The axis designated as the reference or superimposed axis is not available for superimposition.</li> </ul>	
<b>Remedy</b>	
Correct the program.	

<b>P521</b>	<b>Illegal synchronization axis</b>
<b>Details</b>	
The axis specified as the reference or synchronized axis of synchronization between part systems cannot be synchronized.	
<b>Remedy</b>	
♦Correct the program.	
<b>P544</b>	<b>No spec: Wk instl err cmp</b>
<b>Details</b>	
The workpiece installation error compensation function is out of the specifications.	
<b>Remedy</b>	
♦Check the specifications.	
<b>P545</b>	<b>Invlid cmd in wk instl err cmp</b>
<b>Details</b>	
During workpiece installation error compensation, a command impossible to issue (such as G command) was issued.	
<b>Remedy</b>	
♦Check the program. If you wish to issue a command impossible to issue (such as G command) during workpiece installation error compensation, cancel workpiece installation error compensation once.	
<b>P546</b>	<b>Wk instl err cmp cmd invalid</b>
<b>Details</b>	
♦Workpiece installation error compensation was commanded in a G modal in which commanding it is not allowed.	
♦An illegal G command was issued in the block that has a workpiece installation error compensation command.	
<b>Remedy</b>	
♦Check the program. Also check the G modals which were issued at commanding the workpiece installation error compensation, and cancel illegal ones.	
♦Issue the G command in a separate block.	
<b>P547</b>	<b>Illegal wk instl err cmp cmd</b>
<b>Details</b>	
A command in which the rotary axis's travel distance exceeds 180 degrees was issued.	
<b>Remedy</b>	
♦Divide the travel command so that the rotary axis's travel distance per block is less than 180 degrees.	
<b>P550</b>	<b>No spec: G06.2(NURBS)</b>
<b>Details</b>	
There is no NURBS interpolation option.	
<b>Remedy</b>	
♦Check the specifications.	
<b>P551</b>	<b>G06.2 knot error</b>
<b>Details</b>	
The knot (k) command value is smaller than the value for the previous block.	
<b>Remedy</b>	
♦Correct the program.	
♦Specify the knot by monotone increment.	
<b>P552</b>	<b>Start point of 1st G06.2 err</b>
<b>Details</b>	
The block end point immediately before the G06.2 command and the G06.2 first block command value do not match.	
<b>Remedy</b>	
♦Match the G06.2 first block coordinate command value with the previous block end point.	

<b>P554</b>	<b>Invlid manual interrupt in G6.2</b>
	<p><b>Details</b></p> <p>Manual interruption was executed in a block that applies the G06.2 mode.</p> <p><b>Remedy</b></p> <ul style="list-style-type: none"> <li>•Execute the manual interruption in the block that does not apply the G06.2 mode.</li> </ul>
<b>P555</b>	<b>Invalid restart during G06.2</b>
	<p><b>Details</b></p> <p>Restart was attempted from the block that applies G06.2 mode.</p> <p><b>Remedy</b></p> <ul style="list-style-type: none"> <li>•Restart from the block other than in G06.2 mode.</li> </ul>
<b>P560</b>	<b>Fairing changeover disabled</b>
	<p><b>Details</b></p> <ul style="list-style-type: none"> <li>•A command to enable the fairing function was given while the smooth fairing function was ON.</li> <li>•A command to enable the smooth fairing function was given while the fairing function was ON.</li> </ul> <p><b>Remedy</b></p> <ul style="list-style-type: none"> <li>•Correct the program.</li> </ul>
<b>P595</b>	<b>Skip axis illegal</b>
	<p><b>Details</b></p> <ul style="list-style-type: none"> <li>•No axis or more than 2 axes was/were issued to torque limitation skip command block.</li> <li>•An axis during synchronous control was issued as the skip axis.</li> <li>•An axis during inclined axis control was issued as the skip axis.</li> <li>•Geometric command, corner R, or corner chamfering was issued in the same block as torque limitation skip command.</li> <li>•A torque skip was commanded to the axis which is in the constant torque control or the proportional torque stopper control.</li> </ul> <p><b>Remedy</b></p> <ul style="list-style-type: none"> <li>•Issue only an axis to the skip axis.</li> <li>•Review the program.</li> </ul>
<b>P600</b>	<b>No spec: Auto TLM</b>
	<p><b>Details</b></p> <p>An automatic tool length measurement command (G37) was issued though it is out of specifications.</p> <p><b>Remedy</b></p> <ul style="list-style-type: none"> <li>•Check the specifications.</li> </ul>
<b>P601</b>	<b>No spec: Skip</b>
	<p><b>Details</b></p> <p>A skip command (G31) was issued though it is out of specifications.</p> <p><b>Remedy</b></p> <ul style="list-style-type: none"> <li>•Check the specifications.</li> </ul>
<b>P602</b>	<b>No spec: Multi skip</b>
	<p><b>Details</b></p> <p>A multiple skip command (G31.1, G31.2, G31.3 or G31 Pn) was issued though it is out of specifications.</p> <p><b>Remedy</b></p> <ul style="list-style-type: none"> <li>•Check the specifications.</li> </ul>
<b>P603</b>	<b>Skip speed 0</b>
	<p><b>Details</b></p> <p>The skip speed is "0".</p> <p><b>Remedy</b></p> <ul style="list-style-type: none"> <li>•Specify the skip speed.</li> </ul>

<b>P604</b>	<b>TLM illegal axis</b>
<b>Details</b>	
No axis was specified in the automatic tool length measurement block. Otherwise, two or more axes were specified.	
<b>Remedy</b>	
♦Specify only one axis.	
<b>P605</b>	<b>T &amp; TLM command in a block</b>
<b>Details</b>	
The T code is in the same block as the automatic tool length measurement block.	
<b>Remedy</b>	
♦Specify the T code before the automatic tool length measurement block.	
<b>P606</b>	<b>T cmdnd not found before TLM</b>
<b>Details</b>	
The T code was not yet specified in automatic tool length measurement.	
<b>Remedy</b>	
♦Specify the T code before the automatic tool length measurement block.	
<b>P607</b>	<b>TLM illegal signal</b>
<b>Details</b>	
The measurement position arrival signal turned ON before the area specified by the D command or "#8006 ZONE d". Otherwise, the signal remained OFF to the end.	
<b>Remedy</b>	
♦Correct the program.	
<b>P608</b>	<b>Skip during radius compen</b>
<b>Details</b>	
A skip command was issued during radius compensation processing.	
<b>Remedy</b>	
♦Issue a radius compensation cancel (G40) command or remove the skip command.	
<b>P610</b>	<b>Illegal parameter</b>
<b>Details</b>	
♦The parameter setting is not correct.	
- G114.1 was commanded while the spindle synchronization was selected with the PLC interface signal.	
- G110 was commanded while the mixed control (cross axis control) was selected with the PLC interface signal.	
- G125 was commanded while the control axis synchronization between part systems was selected with the PLC interface signal.	
- G126 was commanded while the control axis superimposition was selected with the PLC interface signal.	
<b>Remedy</b>	
♦Correct the settings of "#1514 expLinax (Exponential function interpolation linear axis)" and "#1515 expRotax (Exponential function interpolation rotary axis)".	
- Correct the program.	
- Correct the parameter settings.	
<b>P611</b>	<b>No spec: Exponential function</b>
<b>Details</b>	
There is no specification for the exponential interpolation.	
<b>Remedy</b>	
♦Check the specifications.	



<b>P612</b>	<b>Exponential function error</b>
<b>Details</b>	
A travel command for exponential interpolation was issued during mirror image for facing tool posts.	
<b>Remedy</b>	
•Correct the program.	
<b>P650</b>	<b>Sub sys identification # error</b>
<b>Details</b>	
•The identification No. specified in the address B of G122 or G144 is that of the part system where G122 is given.	
•The identification No. specified in the sub part system control I command (G122) is not set in the parameter #12049 SBS_no.	
<b>Remedy</b>	
•Change the address B of G122 or G144 to be any identification No. other than that of the part system where G122 is given.	
•Select the identification No. for the sub part system control I command (G122) from among the available Nos.	
•Specify the identification No. you wish to use for the sub part system control I command (G122) in the parameter #12049 SBS_no.	
<b>P651</b>	<b>Other G code in sub sys block</b>
<b>Details</b>	
G122 or G144 has been given together with any other G code command in a block.	
<b>Remedy</b>	
•Do not command G122 or G144 together with any other G code command in a block.	
<b>P652</b>	<b>Illegal mode (sub part system)</b>
<b>Details</b>	
G122 or G144 has been commanded in any of the following modes.	
•User macro modal call (G66, G66.1)	
•Fixed cycle mode	
•High-speed mode (G5, G5.1)	
<b>Remedy</b>	
Cancel the following modes before commanding G122 or G144.	
•User macro modal call (G66, G66.1)	
•Fixed cycle mode	
•High-speed mode (G5, G5.1)	
<b>P653</b>	<b>Illegal G code (sub part sys)</b>
<b>Details</b>	
High-speed mode command (G5, G5.1) has been given in a sub part system.	
<b>Remedy</b>	
•Do not use the high-speed mode (G5, G5.1) in a sub part system.	
<b>P656</b>	<b>Illegal PLC device</b>
<b>Details</b>	
•Specified the device other than R register/D register.	
•Specified the odd numbered device when 4 byte is specified.	
•Specified the device number that is out of the command range.	
•Specified the data length that is out of the command range.	
•Specified the bit number that is out of the command range.	
•Omitted the device number.	
•Omitted the project number after ",P".	
•Omitted the data length after ",".	
•Omitted the bit number after ",."	
<b>Remedy</b>	
•Check the program.	

<b>P657</b>	<b>PLC Device too much</b>
<b>Details</b>	
Multiple assignment expressions which include the PLC direct interface command are commanded to the same block.	
<b>Remedy</b>	
♦Command the assignment command using PLC direct interface by itself.	
<b>P700</b>	<b>Illegal command value</b>
<b>Details</b>	
Spindle synchronization was commanded to a spindle that is not connected serially.	
<b>Remedy</b>	
♦Correct the program.	
♦Correct the parameter settings.	
<b>P705</b>	<b>Dia/Rad selection cmd invalid</b>
<b>Details</b>	
G10.9 was commanded during a modal in which diameter/radius designation selection is not available.	
<b>Remedy</b>	
♦Check the program.	
<b>P706</b>	<b>Invld cmd in dia/rad selection</b>
<b>Details</b>	
A G code impossible to command was issued during switching between diameter and radius using the diameter/radius designation selection.	
<b>Remedy</b>	
♦Check the program.	
<b>P721</b>	<b>No selected point for return</b>
<b>Details</b>	
G26 (Return to selected point) has been given in a program other than a machining interruption program.	
<b>Remedy</b>	
♦Correct the program.	
<b>P727</b>	<b>Selected point error</b>
<b>Details</b>	
The command order of the selected point is incorrect.	
<b>Remedy</b>	
♦Correct the program.	
<b>P728</b>	<b>Invalid cmdnd in mach interrupt</b>
<b>Details</b>	
The executed command is unavailable in a machining interruption program.	
<b>Remedy</b>	
♦Correct the program.	
<b>P729</b>	<b>Invalid cmd before tap retract</b>
<b>Details</b>	
The command in the retraction program cannot be executed prior to the tap retraction command (G26).	
<b>Remedy</b>	
♦Place the command after the tap retraction (G26) block.	

<b>P730</b>	<b>Invalid end pt for tap retract</b>
<b>Details</b>	
The position (end point) given to the drill axis in the tap retraction command (G26) is lower than the R-point (closer to the hole bottom).	
<b>Remedy</b>	
•Correct the coordinates of the drill axis command.	
<b>P801</b>	<b>Turning tool offset disabled</b>
<b>Details</b>	
Any of the following commands has been given during the G43.7 mode.	
•Mirror image by G code	
•Mirror image by parameter setting	
•Mirror image by external input	
•Tool length compensation along the tool axis	
•Automatic tool length measurement	
A G43.7 command has been given in any of the following modes.	
•Mirror image by G code	
•Mirror image by parameter setting	
•Mirror image by external input	
•Fixed cycle for drilling	
<b>Remedy</b>	
•Check the program. If you use the mirror image, tool length compensation along the tool axis, automatic tool length measurement or fixed cycle for drilling, use a G49 command to cancel the tool position offset.	
<b>P802</b>	<b>Nose R compensation disabled</b>
<b>Details</b>	
Any of the following commands has been given during nose R compensation for machining center system.	
•Mirror image by G code	
•Mirror image by parameter setting	
•Mirror image by external input	
Nose R compensation for machining center system has been executed in any of the following modes.	
•Mirror image by G code	
•Mirror image by parameter setting	
•Mirror image by external input	
<b>Remedy</b>	
•Check the program. If you use the mirror image, use a G40 command to cancel the nose R compensation for machining center system.	
<b>P803</b>	<b>Proceed of prog check disabled</b>
<b>Details</b>	
The commanded G code has disabled the program check.	
<b>Remedy</b>	
Delete the G code that disables the program check, and then retry the program check. (Note that deleting the G code may affect the operation of the subsequent blocks.)	
<b>P900</b>	<b>No spec: Normal line control</b>
<b>Details</b>	
A normal line control command (G40.1, G41.1, or G42.1) was issued though it is out of specifications.	
<b>Remedy</b>	
•Check the specifications.	
<b>P901</b>	<b>Normal line control axis G92</b>
<b>Details</b>	
A coordinate system preset command (G92) was issued to a normal line control axis during normal line control.	
<b>Remedy</b>	
•Correct the program.	

<b>P902</b>	<b>Normal line control axis error</b>
<b>Details</b>	
<ul style="list-style-type: none"> <li>♦The normal line control axis was set to a linear axis.</li> <li>♦The normal line control axis was set to the linear type rotary axis II axis.</li> <li>♦The normal line control axis has not been set.</li> <li>♦The normal line control axis is the same as the plane selection axis.</li> </ul>	
<b>Remedy</b>	
♦Correct the normal line control axis setting.	
<b>P903</b>	<b>Plane chg in Normal line ctrl</b>
<b>Details</b>	
The plane selection command (G17, G18, or G19) was issued during normal line control.	
<b>Remedy</b>	
♦Delete the plane selection command (G17, G18, or G19) from the program of the normal line control.	
<b>P920</b>	<b>No spec: 3D coord conv</b>
<b>Details</b>	
There is no specification for 3-dimensional coordinate conversion.	
<b>Remedy</b>	
♦Check the specifications.	
<b>P921</b>	<b>Illegal G code at 3D coord</b>
<b>Details</b>	
The commanded G code cannot be performed during 3-dimensional coordinate conversion modal.	
<b>Remedy</b>	
<ul style="list-style-type: none"> <li>♦Refer to "Programming Manual" for usable G commands.</li> <li>♦When the parameter "#8158 Init const sur spd" is enabled, disable the parameter or issue the constant surface speed control cancel (G97) command.</li> </ul>	
<b>P922</b>	<b>Illegal mode at 3D coord</b>
<b>Details</b>	
A 3-dimensional coordinate conversion command was issued during a modal for which 3-dimensional coordinate conversion cannot be performed.	
<b>Remedy</b>	
♦Refer to "Programming Manual" for usable G commands.	
<b>P923</b>	<b>Illegal addr in 3D coord blk</b>
<b>Details</b>	
A G code and G68 was commanded in a block though the G code cannot be commanded with G68.	
<b>Remedy</b>	
♦Refer to "Programming Manual" for usable G commands.	
<b>P924</b>	<b>Travel cmd error in 3Dconvert</b>
<b>Details</b>	
An incorrect travel command has been given during the 3D coordinate conversion mode.	
<b>Remedy</b>	
♦Correct the program.	
<b>P925</b>	<b>End point err in 3D conversion</b>
<b>Details</b>	
The end point of a travel command given during G68.1 ,E1 is not on the tool path.	
<b>Remedy</b>	
♦Correct the program.	

<b>P930</b>	<b>No spec: Tool axis compen</b>
<b>Details</b>	
A tool length compensation along the tool axis command was issued though it is out of specifications.	
<b>Remedy</b>	
•Check the specifications.	
<b>P931</b>	<b>Executing tool axis compen</b>
<b>Details</b>	
There is a G code that cannot be commanded during tool length compensation along the tool axis.	
<b>Remedy</b>	
•Correct the program.	
<b>P932</b>	<b>Rot axis parameter error</b>
<b>Details</b>	
There is an illegal orthogonal axis name or rotary axis name set in the rotary axis configuration parameters.	
There is an illegal setting in the parameter concerning the configuration of the inclined surface machining axis.	
<b>Remedy</b>	
•Set the correct value and turn the power ON again.	
<b>P934</b>	<b>5-axis control config. error</b>
<b>Details</b>	
•The function cannot be executed under the axis configuration of the part system.	
•The rotary axis is in the spindle mode of the spindle position control.	
<b>Remedy</b>	
•Correct the program.	
•Check and correct the rotary axis configuration parameters so that the function can be executed in the axis configuration.	
<b>P940</b>	<b>No spec: Tool tip control</b>
<b>Details</b>	
There is no specification for tool tip center control.	
<b>Remedy</b>	
•Check the specifications.	
<b>P941</b>	<b>Invalid T tip control command</b>
<b>Details</b>	
A tool tip center control command was issued during a modal for which a tool tip center control command cannot be issued.	
<b>Remedy</b>	
•Correct the program.	
<b>P942</b>	<b>Invalid cmdnd during T tip ctrl</b>
<b>Details</b>	
A G code that cannot be commanded was issued during tool tip center control.	
<b>Remedy</b>	
•Correct the program.	
<b>P943</b>	<b>Tool posture command illegal</b>
<b>Details</b>	
In tool tip center control type 1, if the signs at the tool-side rotary axis or table base-side rotary axis start and finish points differ, a tool base-side rotary axis or table workpiece-side rotary axis rotation exists for the same block, and does not pass a singular point.	
In tool tip center control type 2, the posture vector command is incorrect.	
<b>Remedy</b>	
•Correct the program.	

<b>P950</b>	<b>No spec: Tilt face machining</b>
<b>Details</b>	
Inclined surface machining option is not supported.	
<b>Remedy</b>	
♦Check the specifications.	
<b>P951</b>	<b>Ill cmd in tilt face machining</b>
<b>Details</b>	
A forbidden command (G command, etc.) was issued during inclined surface machining.	
<b>Remedy</b>	
♦Check the program. If you want to execute a command (G command, etc.) that is unavailable during inclined surface machining, cancel the inclined surface machining.	
<b>P952</b>	<b>Inclined face cut prohibited</b>
<b>Details</b>	
Inclined surface machining was commanded during the mode where the machining is unavailable. Inclined surface machining was commanded during interruption.	
<b>Remedy</b>	
♦Check the program and see whether any unavailable mode is included during inclined surface machining command. If any, cancel that mode.	
<b>P953</b>	<b>Tool axis dir cntrl prohibited</b>
<b>Details</b>	
Tool axis direction control was commanded during the mode where the control is unavailable.	
<b>Remedy</b>	
♦Check the program and see whether any unavailable mode is included during tool axis direction control. If any, cancel that mode.	
<b>P954</b>	<b>Inclined face command error</b>
<b>Details</b>	
The address to issue the inclined surface machining command is incorrect.	
<b>Remedy</b>	
♦Check the program.	
<b>P955</b>	<b>Inclined face coord illegal</b>
<b>Details</b>	
Impossible to define an inclined surface with the values you specified.	
<b>Remedy</b>	
♦Check the program.	
<b>P956</b>	<b>G68.2P10 surface not defined</b>
<b>Details</b>	
The coordinate system for the machining surface selected with G68.2P10 has not been defined.	
<b>Remedy</b>	
♦Set the machining surface so that the coordinate system can be defined.	
<b>P957</b>	<b>Tool axis dir ctrl cmp amt 0</b>
<b>Details</b>	
When the tool axis direction control type 2 (G53.6) was commanded, a tool length compensation No. whose compensation amount is 0 was commanded.	
<b>Remedy</b>	
♦Correct the program. Set the tool length compensation amount, or command a tool length compensation No. whose compensation amount is not 0.	

<b>P958</b>	<b>Tool axis dir ctrl axis illeg</b>
<b>Details</b>	
The command was issued with an angle with which tool axis direction control of 4-axis configuration is not available.	
<b>Remedy</b>	
•Check the feature coordinate system defined in inclined surface machining command.	
<b>P959</b>	<b>No spec: Simple inclined face</b>
<b>Details</b>	
Simple inclined surface machining is not included in the specifications.	
<b>Remedy</b>	
•Check the specifications.	
<b>P960</b>	<b>No spec: Direct command mode</b>
<b>Details</b>	
G05 P4 was commanded while direct command mode option is OFF.	
<b>Remedy</b>	
•Check the specifications.	
<b>P961</b>	<b>Invalid during dir cmnd mode</b>
<b>Details</b>	
•A G code other than G05 P0 was commanded in direct command mode.	
•A sequence No. command, F code command, MSTB command or variable command was issued.	
•A corner chamfering command or corner R command was issued.	
•A travel command was issued to an axis that had not been command in the G05 P4 block.	
<b>Remedy</b>	
•Check the program.	
<b>P962</b>	<b>Dir cmnd mode cmnd invalid</b>
<b>Details</b>	
G05 P4 was commanded in a modal where direct command mode is not available.	
<b>Remedy</b>	
•Check the program.	
<b>P963</b>	<b>Illegal direct cmnd mode cmnd</b>
<b>Details</b>	
The commanded coordinate value was beyond the maximum travel distance in direct command mode.	
<b>Remedy</b>	
•Correct the coordinate value in direct command mode.	
<b>P990</b>	<b>PREPRO error</b>
<b>Details</b>	
Combining commands that required pre-reading (nose R offset, corner chamfering/corner rounding, geometric I, geometric IB, and compound type fixed cycle for turning machining) resulted in eight or more pre-read blocks.	
<b>Remedy</b>	
•Delete some or all of the combinations of commands that require pre-reading.	

---

## Smart Safety Observation Alarm (V)



## 13.1 Smart Safety Observation Error (V01/V02/V03/V04/V05/V06/V07)

<b>V01</b>	<b>Safety watchdog error</b>	0001	
<b>Details</b>			
Safety function is not carried out in specified cycle.			
<b>Remedy</b>			
•CPU may be faulty. Contact our service center.			
<b>V01</b>	<b>Cross-check error</b>	0002	
<b>Details</b>			
Each operation result of redundant CPU is different value.			
<b>Remedy</b>			
•CPU may be faulty. Contact our service center.			
<b>V01</b>	<b>Safe sys internal process err</b>	0003	Function No.
<b>Details</b>			
An error has occurred in the NC's internal process during execution of a safety function. The screen displays which safety function has been executed at the time of error, using the following numbers.			
0001: Safely-limited speed (SLS)			
0002: Safely-limited position (SLP)			
0003: Safe speed monitor (SSM)			
0004: Safe cam (SCA)			
0005: Safe operating stop (SOS)			
0006: Safe stop 1 (SS1)			
0007: Safe stop 2 (SS2)			
0008: Safe torque off (STO)			
0009: Safe brake control (SBC)			
000A: Diagnostic function			
000B: Safety I/O-related observation			
<b>Remedy</b>			
•CPU may be faulty. Contact our service center.			
<b>V01</b>	<b>Safe para storage memory err 1</b>	0004	
<b>Details</b>			
Safety parameter (for internal processing) which is saved in the memory is illegal value.			
<b>Remedy</b>			
•Input Safety parameter file and turn power ON again.			
•Clear the memory. (All data on the memory will be initialized. Back up the data as needed.)			
•When the above action does not help restoring, memory may be faulty. Contact our service center.			
<b>V01</b>	<b>Safe para storage memory err 2</b>	0005	
<b>Details</b>			
Safety parameter which is saved in the memory is illegal value.			
<b>Remedy</b>			
•Input Safety parameter file and turn power ON again.			
•Clear the memory. (All data on the memory will be initialized. Back up the data as needed.)			
•When the above action does not help restoring, memory may be faulty. Contact our service center.			
<b>V01</b>	<b>Safety initial process timeout</b>	0006	
<b>Details</b>			
The initialization process of the safety function at power ON is not completed within specified time.			
<b>Remedy</b>			
•CPU may be faulty. Contact our service center.			

<b>V01</b>	<b>NC-DRV initial safe comm error</b>	0007	Axis name
<b>Details</b>			
The initial communication between NC unit and drive unit is incorrect. Displays the name of axis with error.			
<b>Remedy</b>			
<ul style="list-style-type: none"> <li>♦Check if there is no contact failure or no cable fracture after NC/Drive power OFF.</li> <li>♦NC unit or drive unit may be faulty. Contact our service center.</li> </ul>			
<b>V01</b>	<b>Safe I/O init. process timeout</b>	0008	Unit info
<b>Details</b>			
The safety I/O initialization process at power-up has not completed within the specified time. Displays the information of the unit with an error.			
bit24-27: Unit No.			
(*) The unit No. indicates the unit in which an alarm occurs.			
The channel No. and station No. to which the unit is connected can be confirmed by the following parameters.			
Channel No.: #51501 + 10 × (Unit No. - 1)			
Station No.: #51502 + 10 × (Unit No. - 1)			
<b>Remedy</b>			
♦Safety I/O unit may be faulty. Exchange the safety I/O unit.			
<b>V02</b>	<b>Encoder error</b>	0001	Axis name
<b>Details</b>			
The feedback position received from drive unit is incorrect. Displays the name of axis with error.			
<b>Remedy</b>			
♦Encoder may be faulty. Contact our service center.			
<b>V02</b>	<b>NC-DRV safe communication err</b>	0004	Axis name
<b>Details</b>			
The communication between NC unit and drive unit is incorrect. Displays the name of axis with error.			
<b>Remedy</b>			
<ul style="list-style-type: none"> <li>♦Check if there is no contact failure or no cable fracture after NC/Drive power OFF.</li> <li>♦NC unit or drive unit may be faulty. Contact our service center.</li> </ul>			
<b>V02</b>	<b>Excess movement during pwr OFF</b>	0005	Axis name
<b>Details</b>			
[Saved position at power shut OFF] and [restored position at power ON] are inconsistent in SLP/SCA encoder diagnosis during power OFF. Displays the name of axis with error.			
<b>Remedy</b>			
There are two causes of this alarm; one is "the axis being moved during power OFF" and the other is "the incorrect restoring of the position at power ON".			
♦When it is likely with the cause "the axis being moved during power OFF", the alarm can be cancelled by turning ON the Safety reset signal while the Special safety alarm cancel signal is ON.			
♦When it is likely with the cause "the incorrect restoring of the position at power ON", encoder may be faulty. Contact our service center.			

V03	Slave station comm. error 1	0001	Unit info
<b>Details</b>			
The data received by the safety I/O unit is incorrect. Displays the information of the unit with an error.			
bit24-27: Unit No.			
Safety observation target axes are stopped, and all the DOs of the safety I/O unit concerned are turned OFF.			
(*) The unit No. indicates the unit in which an alarm occurs. The channel No. and station No. to which the unit is connected can be confirmed by the following parameters.			
Channel No.: #51501 + 10 × (Unit No. - 1)			
Station No.: #51502 + 10 × (Unit No. - 1)			
<b>Remedy</b>			
•NC unit or safety I/O unit may be faulty. Exchange the NC unit or safety I/O unit.			
V03	Slave station comm. error 2	0002	Unit info
<b>Details</b>			
The data received by the safety I/O unit is incorrect. Displays the information of the unit with an error.			
bit24-27: Unit No.			
Safety observation target axes are stopped, and all the DOs of the safety I/O unit concerned are turned OFF.			
(*) The unit No. indicates the unit in which an alarm occurs. The channel No. and station No. to which the unit is connected can be confirmed by the following parameters.			
Channel No.: #51501 + 10 × (Unit No. - 1)			
Station No.: #51502 + 10 × (Unit No. - 1)			
<b>Remedy</b>			
•NC unit or safety I/O unit may be faulty. Exchange the NC unit or safety I/O unit.			
V03	Slave station comm. error 3	0003	Unit info
<b>Details</b>			
The data received by the safety I/O unit is incorrect. Displays the information of the unit with an error.			
bit24-27: Unit No.			
Safety observation target axes are stopped, and all the DOs of the safety I/O unit concerned are turned OFF.			
(*) The unit No. indicates the unit in which an alarm occurs. The channel No. and station No. to which the unit is connected can be confirmed by the following parameters.			
Channel No.: #51501 + 10 × (Unit No. - 1)			
Station No.: #51502 + 10 × (Unit No. - 1)			
<b>Remedy</b>			
•NC unit or safety I/O unit may be faulty. Exchange the NC unit or safety I/O unit.			

V03	Slave station data compare err	0004	Unit info
<b>Details</b>			
The data received by the safety I/O unit is inconsistent. Displays the information of the unit with an error.			
bit24-27: Unit No.			
Safety observation target axes are stopped, and all the DOs of the safety I/O unit concerned are turned OFF.			
(*) The unit No. indicates the unit in which an alarm occurs. The channel No. and station No. to which the unit is connected can be confirmed by the following parameters.			
Channel No.: #51501 + 10 × (Unit No. - 1)			
Station No.: #51502 + 10 × (Unit No. - 1)			
<b>Remedy</b>			
<ul style="list-style-type: none"> <li>◆Check the user safety sequence circuit to see if the output signal control circuit is correct.</li> <li>◆Data corruption may have been caused due to noise. Take anti-noise measures on the connection between the NC unit and safety I/O unit.</li> <li>◆NC unit or safety I/O unit may be faulty. Exchange the NC unit or safety I/O unit.</li> </ul>			
V03	Output OFF check error	0005	Unit info
<b>Details</b>			
Output signal of the safety I/O unit fails to be OFF. Displays the information of the unit with an error.			
bit0-31: Signal BIT			
Safety observation target axes are stopped.			
<b>Remedy</b>			
<ul style="list-style-type: none"> <li>◆NC unit or safety I/O unit may be faulty. Exchange the NC unit or safety I/O unit.</li> </ul>			
V03	Output signal cross-check err	0006	Unit info
<b>Details</b>			
Loop-back signals of the outputs from the safety I/O unit are inconsistent between PLC1 and PLC2. Displays the information of the unit with an error.			
bit0-31: Signal BIT			
Safety observation target axes are stopped.			
<b>Remedy</b>			
<ul style="list-style-type: none"> <li>◆Check the user safety sequence circuit to see if the output signal control circuit is correct.</li> <li>◆NC unit or safety I/O unit may be faulty. Exchange the NC unit or safety I/O unit.</li> </ul>			
V03	Transmission cross-check error	0007	Unit info
<b>Details</b>			
Output signals are inconsistent between the user safety sequence and safety I/O unit. Displays the information of the unit with an error.			
bit0-31: Signal BIT			
Safety observation target axes are stopped.			
<b>Remedy</b>			
<ul style="list-style-type: none"> <li>◆Check the user safety sequence circuit to see if the output signal control circuit is correct.</li> <li>◆NC unit or safety I/O unit may be faulty. Exchange the NC unit or safety I/O unit.</li> </ul>			
V03	Reception cross-check error	0008	Unit info
<b>Details</b>			
Input signals from the safety I/O unit are inconsistent between PLC1 and PLC2. Displays the information of the unit with an error.			
bit0-31: Signal BIT			
Safety observation target axes are stopped.			
<b>Remedy</b>			
<ul style="list-style-type: none"> <li>◆Any input device (emergency stop button, for example) connected to the safety I/O unit may be faulty. Check the input devices.</li> <li>◆NC unit or safety I/O unit may be faulty. Exchange the NC unit or safety I/O unit.</li> </ul>			

V03	Host station comm. error 1	0009	Unit info
<b>Details</b>			
The data received from the safety I/O unit is incorrect. Displays the information of the unit with an error. bit24-27: Unit No. Safety observation target axes are stopped.			
(*) The unit No. indicates the unit in which an alarm occurs. The channel No. and station No. to which the unit is connected can be confirmed by the following parameters. Channel No.: #51501 + 10 × (Unit No. - 1) Station No.: #51502 + 10 × (Unit No. - 1)			
<b>Remedy</b>			
♦Data corruption may have been caused due to noise. Take anti-noise measures on the connection between the NC unit and safety I/O unit. ♦NC unit or safety I/O unit may be faulty. Exchange the NC unit or safety I/O unit.			
V03	Host station comm. error 2	0010	Unit info
<b>Details</b>			
The data received from the safety I/O unit is incorrect. Displays the information of the unit with an error. bit24-27: Unit No. Safety observation target axes are stopped.			
(*) The unit No. indicates the unit in which an alarm occurs. The channel No. and station No. to which the unit is connected can be confirmed by the following parameters. Channel No.: #51501 + 10 × (Unit No. - 1) Station No.: #51502 + 10 × (Unit No. - 1)			
<b>Remedy</b>			
♦NC unit or safety I/O unit may be faulty. Exchange the NC unit or safety I/O unit.			
V03	Host station comm. error 3	0011	Unit info
<b>Details</b>			
The data received from the safety I/O unit is incorrect. Displays the information of the unit with an error. bit24-27: Unit No. Safety observation target axes are stopped.			
(*) The unit No. indicates the unit in which an alarm occurs. The channel No. and station No. to which the unit is connected can be confirmed by the following parameters. Channel No.: #51501 + 10 × (Unit No. - 1) Station No.: #51502 + 10 × (Unit No. - 1)			
<b>Remedy</b>			
♦The cable connecting between the NC unit and safety I/O unit may be disconnected or loosened. Check the cable. ♦NC unit or safety I/O unit may be faulty. Exchange the NC unit or safety I/O unit.			
V03	Drv safe receive crosscheck er	0012	ZR device No.
<b>Details</b>			
The input signals from the drive's safety function are inconsistent. The screen displays the No. of device ZR with an error. Safety observation target axes are stopped.			
<b>Remedy</b>			
♦NC unit may be faulty. Exchange the NC unit.			

<b>V03</b>	<b>User safety sequence 1 error</b>	0013	Error cause number
<b>Details</b>			
<p>An error has occurred in User safety sequence 1.  The screen displays the error cause by the number.  Safety observation target axes are stopped.  User safety sequences 1 and 2 are both stopped.  All the DOs of the connected safety I/O unit are turned OFF.</p>			
<b>Remedy</b>			
<ul style="list-style-type: none"> <li>♦Refer to the list of user safety sequence error details in Smart safety observation Specification manual. Cancel the error based on the displayed error cause, and then turn OFF and ON the NC power.</li> </ul>			
<b>V03</b>	<b>User safety sequence 2 error</b>	0014	Error cause number
<b>Details</b>			
<p>An error has occurred in User safety sequence 2. The screen displays the error cause.  Safety observation target axes are stopped.  User safety sequences 1 and 2 are both stopped.  All the DOs of the connected safety I/O unit are turned OFF.</p>			
<b>Remedy</b>			
<ul style="list-style-type: none"> <li>♦Refer to the list of user safety sequence error details in Smart safety observation Specification manual. Cancel the error based on the displayed error cause, and then turn OFF and ON the NC power.</li> </ul>			
<b>V03</b>	<b>Output sig. cross check error</b>	0015	Unit info
<b>Details</b>			
<p>The signals output to the safety I/O unit are unmatched between PLC1 and PLC2.  Displays the information of the unit with an error.</p> <p>bit0-31: Signal BIT</p> <p>The axes covered by safety function come to a standstill.</p>			
<b>Remedy</b>			
<ul style="list-style-type: none"> <li>♦Check the user safety sequence to make sure the output signal control circuit is correct.</li> <li>♦Set tolerable time more than 300ms, when an output signal is controlled with 100ms timer.</li> <li>♦NC unit may be faulty. Replace the NC unit.</li> </ul>			
<b>V04</b>	<b>Safety observation &amp; Smart both ON</b>	0001	
<b>Details</b>			
<p>The system has both an axis for which Safety observation is enabled (the parameter "#2313 SV113(SSF8)/bitF" or "#13229 SP229(SFNC9)/bitF" is "1") and an axis for which Smart safety observation is enabled (the parameter "#51101 SF_Disable" or "#51301 SF_SDisable" is "0").</p>			
<b>Remedy</b>			
<ul style="list-style-type: none"> <li>♦Disable Safety observation for all the axes (Set the parameters "#2313 SV113(SSF8)/bitF" and "#13229 SP229(SFNC9)/bitF" to "0"), and turn ON the NC reset signal.</li> <li>♦Disable Smart safety observation for all the axes (Set the parameters "#51101 SF_Disable" and "#51301 SF_SDisable" to "1"), and turn the power OFF and ON.</li> </ul>			
<b>V04</b>	<b>Safety IO device unconnectable</b>	0002	Safety I/O unit-connect- ed channel
<b>Details</b>			
<p>A safety I/O unit has been connected with the smart safety observation option OFF or with the parameters "#51101 SF_Disable" and "#51301 SF_SDisable" set to "1" for all the axes. The screen displays the channel to which the safety I/O unit is connected by the bit number.</p> <p>bit0: Operation panel  bit1: RIO 1CH  bit2: RIO 2CH  bit3: RIO 3CH</p>			
<b>Remedy</b>			
<ul style="list-style-type: none"> <li>♦Disconnect the safety I/O unit, and then turn OFF and ON the power.</li> <li>♦If you wish to use Smart safety observation, implement the following and then turn the power OFF and ON. <ul style="list-style-type: none"> <li>- Enable the option.</li> <li>- Turn "0" the axis parameter of Smart safety observation ("#51101 SF_Disable" / "#51301 SF_SDisable").</li> </ul> </li> </ul>			

<b>V04</b>	<b>Safe IO disabled: connect err</b>	0003	Safety I/O unit-connected channel
<b>Details</b>			
A safety I/O unit has been connected to the I/O connection channel where RIO1.0 unit is connected. The screen displays the I/O connection channel to which the safety I/O unit is connected using a bit number.			
bit0: Operation panel			
bit1: RIO 1CH			
bit2: RIO 2CH			
bit3: RIO 3CH			
<b>Remedy</b>			
<ul style="list-style-type: none"> <li>•For the I/O connection channel where the safety signal input/output is conducted, no devices other than RIO2.0 unit or safety I/O unit can be connected.</li> <li>•If you are unable to change the I/O device configuration immediately, set the parameters "#51101 SF_Disable" and "#51301 SF_SDisable" to "1" for all the axes, and turn OFF and ON the power. This prevents occurrence of this alarm.</li> </ul>			
<b>V04</b>	<b>Safe IO disabled: no safe I/Os</b>	0004	
<b>Details</b>			
None of the I/O connection channels is connected to a safety I/O unit.			
<b>Remedy</b>			
<ul style="list-style-type: none"> <li>•Connect a safety I/O unit to the I/O connection channel through which the safety signals are input/output.</li> <li>•If you are unable to change the I/O device configuration immediately, set the parameters "#51101 SF_Disable" and "#51301 SF_SDisable" to "1" for all the axes, and turn OFF and ON the power. This prevents occurrence of this alarm.</li> </ul>			
<b>V04</b>	<b>Safety PLC is not yet written</b>	0005	
<b>Details</b>			
Safety PLC has not been written.			
<b>Remedy</b>			
<ul style="list-style-type: none"> <li>•Write safety PLC and turn the power OFF and ON.</li> <li>•If safety PLC is not ready, set the parameters "#51101 SF_Disable" and "#51301 SF_SDisable" to "1" for all the axes, and then turn the power OFF and ON. This prevents occurrence of this alarm.</li> </ul>			
<b>V04</b>	<b>NC-DRV safety comm. Disabled</b>	0006	Optical channel No.
<b>Details</b>			
The optical channel connected to an axis for which the parameter "#51101 SF_Disable" or "#51301 SF_SDisable" is set to "0" is configured with any drive unit other than MDS-E Series. (MDS-D Series drive unit is connected to the said channel.)			
The screen displays the No. of optical communication channel of this error.			
<b>Remedy</b>			
<ul style="list-style-type: none"> <li>•Do not connect any drive unit other than MDS-E Series to the optical channel of the axis for which the parameter "#51101 SF_Disable" or "#51301 SF_SDisable" is set to "0".</li> <li>•If an MDS-E Series drive unit is not ready, set the parameters "#51101 SF_Disable" / "#51301 SF_SDisable" to "1" for all the axes of the said channel, and then turn OFF and ON the power. This prevents occurrence of this alarm.</li> </ul>			

<b>V04</b>	<b>EMG stop signal device illegal</b>	0007	Emergency stop device index No.
<b>Details</b>			
<p>The channel No. or station No. of the emergency stop signal device (set by parameters) does not coincide with any contact point (channel/station No. specified by the safety I/O assignment parameters RIO CH No and RIO Station No.) of the safety I/O unit. The screen displays the index No. of the incorrectly set emergency stop signal device.</p> <p>0001: EMG_Dev1_ch to EMG_Dev1_bit 0002: EMG_Dev2_ch to EMG_Dev2_bit</p>			
<b>Remedy</b>			
<ul style="list-style-type: none"> <li>♦Change the channel, station or bit No. of emergency stop signal device to be one of the contact points of the safety I/O unit. And then turn OFF and ON the power.</li> <li>♦When you change the setting of emergency stop signal device channel No. (EMG_Dev1_ch / EMG_Dev2_ch) to 0, and turn OFF and ON the power, the designation of emergency stop signal device is disabled, so this alarm is cleared.</li> </ul>			
<b>V04</b>	<b>Safe IO assign para setting er</b>	0009	Channel No.
<b>Details</b>			
<p>Safety I/O device assignment parameter is incorrect.</p> <ul style="list-style-type: none"> <li>♦The safety I/O device assignment parameter of the connected safety I/O unit is not set.</li> <li>♦The safety I/O device assignment parameter is set for any disconnected safety I/O unit.</li> <li>♦The set channel No. or station No. is overlapped.</li> </ul>			
<b>Remedy</b>			
<ul style="list-style-type: none"> <li>♦Make sure which safety I/O unit is connected, set the safety I/O device assignment parameters, and then turn OFF and ON the power.</li> </ul>			
<b>V04</b>	<b>Safety I/O param inconsistent</b>	0011	
<b>Details</b>			
<p>There is a discrepancy between the PLC side parameter (I/O allocation setting) and CNC side parameter (safety I/O allocation).</p> <ul style="list-style-type: none"> <li>♦The setting of "Top XY" on the PLC side is different from "DI(DO) dev No." on the CNC side.</li> <li>♦The number of registered safety signal units is different between PLC and CNC sides.</li> </ul>			
<b>Remedy</b>			
<p>Correct the parameters to be consistent between PLC and CNC. After that turn OFF and ON the CNC power.</p>			
<b>V05</b>	<b>SLS speed error</b>	0001	Axis name
<b>Details</b>			
<p>During SLS observation, the command/FB speed has exceeded the safely-limited speed(*) and has not dropped below the speed limit within the SLS detection delay time (set by parameter). The screen displays the name of axis of this error.</p> <p>(*)Safely-limited speed = SLS speed tolerance x SLS speed override / 100</p>			
<b>Remedy</b>			
<ul style="list-style-type: none"> <li>♦This error can be cancelled by the safety reset signal while motor speed is under SLS limit.</li> <li>♦If the SLS speed tolerance or SLS speed override (set by parameter) is lower than the assumption, change the parameter setting and turn OFF and ON the power.</li> <li>♦If the SLS detection delay time (set by parameter) is shorter than the assumption, change the parameter setting.</li> <li>♦Check the safety ladder to make sure that SLS speed tolerance and SLS speed override are changed in a timely manner.</li> </ul>			



V05	SLS deceleration error	0002	Axis name
<b>Details</b>			
<p>The command/FB speed has failed to decelerate to the safely-limited speed(*) or lower within a period of SLS deceleration observation time (set by parameter) after start of SLS observation. The screen displays the name of axis of this error.</p> <p>(*)Safely-limited speed = SLS speed tolerance x SLS speed override / 100</p>			
<b>Remedy</b>			
<ul style="list-style-type: none"> <li>•This error can be cancelled by the safety reset signal while motor speed is under SLS limit.</li> <li>•If the SLS speed tolerance or SLS speed override (set by parameter) is lower than the assumption, change the parameter setting and turn OFF and ON the power.</li> <li>•If the SLS deceleration observation time (set by parameter) is shorter than the assumption, change the parameter setting.</li> </ul>			
V05	SLP position error	0003	Axis name
<b>Details</b>			
<p>The command position/FB position has gone out of the SLP position tolerance range (set by parameter) during the SLP observation, and failed to return to the tolerance range within the SLP detection delay time (set by parameter). The screen displays the name of axis of this error.</p>			
<b>Remedy</b>			
<ul style="list-style-type: none"> <li>•This error can be cancelled by the safety reset signal while the axis is in the SLP position range.</li> <li>•If the axis is out of the SLP position range, deactivate SLP observation, cancel this error using the safety reset signal, and then move the axis to a safe position in a manual mode.</li> <li>•If the safely-limited position range (specified by the SLP position tolerance parameters) is smaller than the assumption, change the parameter settings and turn OFF and ON the power.</li> <li>•If the SLP detection delay time (set by parameter) is shorter than the assumption, change the parameter setting.</li> <li>•Check the safety ladder to make sure that SLP position tolerance is changed in a timely manner.</li> </ul>			
V05	SOS speed error	0004	Axis name
<b>Details</b>			
<p>The command/FB speed, which had exceeded the SOS stop speed (set by parameter) during SOS, has failed to drop to the SOS stop speed or lower within the SOS_V detection delay time (set by parameter). The screen displays the name of axis of this error.</p> <p>*If the conditions of two or more SOS-related alarms are met at a time, the notification priority order is as follows: SOS position deviation error &gt; SOS travel distance error &gt; SOS speed error.</p>			
<b>Remedy</b>			
<ul style="list-style-type: none"> <li>•This error can be cancelled by the safety reset signal while In SOS stop is ON.</li> <li>•If In SOS stop is OFF, deactivate SOS, cancel this error using the safety reset signal, and then move the axis to a safe position in a manual mode.</li> <li>•If the parameter of SOS stop speed is lower than the assumption, change the setting and turn OFF and ON the power.</li> <li>•If the SOS_V detection delay time (set by parameter) is shorter than the assumption, change the parameter setting.</li> </ul>			
V05	SOS position deviation error	0005	Axis name
<b>Details</b>			
<p>The position deviation (difference between the command and FB positions), which had exceeded the SOS position deviation tolerance (set by parameter) during SOS, has failed to reduce to the SOS position deviation tolerance or smaller within the SOS_PD detection delay time (set by parameter). The screen displays the name of axis of this error.</p> <p>*If the conditions of two or more SOS-related alarms are met at a time, the notification priority order is as follows: SOS position deviation error &gt; SOS travel distance error &gt; SOS speed error.</p>			
<b>Remedy</b>			
<ul style="list-style-type: none"> <li>•Refer to the corrective actions of "SOS speed error" for how to cancel this error.</li> <li>•If the SOS position deviation tolerance (set by parameter) is smaller than the assumption, change the setting and turn OFF and ON the power.</li> <li>•If the SOS_PD detection delay time (set by parameter) is shorter than the assumption, change the parameter setting.</li> </ul>			

V05	SOS travel distance error	0006	Axis name
<b>Details</b>			
<p>The command/FB travel distance, which had exceeded the SOS travel distance tolerance (+/-) (set by parameter) during SOS, has failed to reduce to the SOS travel distance tolerance (+/-) or smaller within the SOS_P detection delay time (set by parameter). The screen displays the name of axis of this error.</p> <p>*If the conditions of two or more SOS-related alarms are met at a time, the notification priority order is as follows: SOS position deviation error &gt; SOS travel distance error &gt; SOS speed error.</p>			
<b>Remedy</b>			
<ul style="list-style-type: none"> <li>◆Refer to the corrective actions of "SOS speed error" for how to cancel this error.</li> <li>◆If the SOS travel distance tolerance (+/-) (set by parameter) is smaller than the assumption, change the setting and turn OFF and ON the power.</li> <li>◆If the SOS_P detection delay time (set by parameter) is shorter than the assumption, change the parameter setting.</li> </ul>			
V05	SS1 deceleration error	0007	Axis name
<b>Details</b>			
<p>The SS1 deceleration observation time (set by parameter) has elapsed with the command/FB speed exceeding the SOS stop speed (set by parameter) since the start of SS1. The screen displays the name of axis of this error.</p>			
<b>Remedy</b>			
<ul style="list-style-type: none"> <li>◆This error can be cancelled by the safety reset signal while In SS1 stop is ON.</li> <li>◆If the SS1 deceleration observation time (set by parameter) is shorter than the assumption, change the parameter setting.</li> </ul>			
V05	SS2 deceleration error	0008	Axis name
<b>Details</b>			
<p>The command/FB speed has been exceeding the SOS stop speed (set by parameter) for a period of SS2 deceleration observation time (set by parameter) since the start of SS2. The screen displays the name of axis of this error.</p>			
<b>Remedy</b>			
<ul style="list-style-type: none"> <li>◆Deactivate SS2, cancel this error using the safety reset signal, and then move the axis to a safe position in a manual mode.</li> <li>◆If the SS2 deceleration observation time (set by parameter) is shorter than the assumption, change the parameter setting.</li> </ul>			
V06	Safety external EMG stop is ON	0001	
<b>Details</b>			
<p>Emergency stop signal is OFF (open status), although Safety external emergency stop is enabled.</p>			
<b>Remedy</b>			
<ul style="list-style-type: none"> <li>◆Ensure the safety of the machine, and then turn the emergency stop signal ON (close status).</li> </ul>			
V07	DRV safe circuit error	Error No.	Axis name
<b>Details</b>			
<p>The drive unit's internal safety circuit has caused abnormal operation. The error number corresponding to the contents of abnormal operation appears.</p>			
<b>Remedy</b>			
<ul style="list-style-type: none"> <li>◆Drive unit may be damaged. Replace the drive unit.</li> </ul>			

## 13.2 Smart Safety Observation Warning (V50/V51/V52/V53/V54)

<b>V50</b>	<b>SSM hysteresis setting error</b>	0001	Axis name
<b>Details</b>			
The SSM hysteresis width (set by parameter) is greater than the SSM speed (set by parameter). The screen displays the name of axis of this error.			
<b>Remedy</b>			
•Change the SSM hysteresis width parameter to be a smaller value than the SSM speed.			
<b>V50</b>	<b>Safe absol. posn unestablished</b>	0002	Axis name
<b>Details</b>			
•After enabling SLP/SCA (Parameter SLP_Enable/SCA_Enable is 1), the Safety absolute position has never been established. •In SLP/SCA encoder diagnosis during power OFF, [saved position at power shut OFF] and [restored position at power ON] are inconsistent. While this alarm is ON, SLP/SCA will not operate. Displays the name of axis of this error.			
<b>Remedy</b>			
•This alarm can be cancelled by turning ON the Safety absolute position check signal. Before turning ON the Safety absolute position check signal, however, move the axis by manual operation to the position where the coordinate value is clear (the position that is marked or the reference position etc.) (When in the relative position detection system, it requires to operate reference position return to establish the reference position.) then compare the actual position and the displayed position to confirm the both position is corresponding.			
<b>V51</b>	<b>SBT start disabled</b>	0001	Factor No.
<b>Details</b>			
When turning ON the SBT start signal (SBTSTEXm / SBTSTMOM), the test start condition are not met. Displays the factor why the brake test start is impossible * When there are multiple factors, the smaller item is shown. 0001: part systems in automatic operation 0002: not in in-position 0003: in servo OFF state. 0004: in current limit 0005: the secondary axis in the synchronous control 0006: in superimposition control 0007: in arbitrary axis exchange control 0008: in mixed control 0009: Parameter for SBT error 000A: reference position establishment incomplete 000B: applies exclusive control of SBT 000C: the secondary axis SBT disabled 000D: the secondary axis SBT start disabled 000E: the secondary axis in single method			
<b>Remedy</b>			
•Check the start-enabled condition of the brake test. Eliminate the cause of the alarm, then enable the SBT start signal to start the brake test.			
<b>V51</b>	<b>SBT warning 1</b>	0002	Axis name
<b>Details</b>			
The axis movement amount exceeded the tolerable value in external brake test pattern 1. Displays the name of axis with the error.			
<b>Remedy</b>			
•Move the axis to safe position by manual operation. Take corrective action to the brake after the power OFF. Then turn power ON and carry out the brake test again. This alarm will be cancelled when the test completes normally. •This alarm can be cancelled with the safety reset signal. The external brake SBT incomplete signal (SBT-NFEXm), however, remains ON.			

<b>V51</b>	<b>SBT warning 4</b>	0005	Axis name
<b>Details</b>			
The axis movement amount exceeded the tolerable value in the test pattern 1 of motor brake test. Displays the name of axis with the error.			
<b>Remedy</b>			
<ul style="list-style-type: none"> <li>♦Move the axis to safe position by manual operation. Take corrective action to the brake after the power OFF. Then turn power ON and carry out the brake test again. This alarm will be cancelled when the test completes normally.</li> <li>♦This alarm can be cancelled with the safety reset signal. The external brake SBT incomplete signal (SBT-NFEXm), however, remains ON.</li> </ul> When this alarm is cancelled with the safety reset signal, however, the motor brake SBT incomplete signal (SBTNFMOM) remains ON.			
<b>V51</b>	<b>SBT warning 5</b>	0006	Axis name
<b>Details</b>			
The axis movement amount exceeded the tolerable value in the test pattern 2 of motor brake test. Displays the name of axis with the error.			
<b>Remedy</b>			
<ul style="list-style-type: none"> <li>♦Move the axis to safe position by manual operation. Take corrective action to the brake after the power OFF. Then turn power ON and carry out the brake test again. This alarm will be cancelled when the test completes normally.</li> <li>♦This alarm can be cancelled with the safety reset signal. The external brake SBT incomplete signal (SBT-NFEXm), however, remains ON.</li> </ul> When this alarm is cancelled with the safety reset signal, however, the motor brake SBT incomplete signal (SBTNFMOM) remains ON.			
<b>V51</b>	<b>SBT warning 6</b>	0007	Axis name
<b>Details</b>			
The axis movement amount exceeded the tolerable value in the test pattern 3 of motor brake test. Displays the name of axis with the error.			
<b>Remedy</b>			
<ul style="list-style-type: none"> <li>♦Move the axis to safe position by manual operation. Take corrective action to the brake after the power OFF. Then turn power ON and carry out the brake test again. This alarm will be cancelled when the test completes normally.</li> <li>♦This alarm can be cancelled with the safety reset signal. The external brake SBT incomplete signal (SBT-NFEXm), however, remains ON.</li> </ul> When this alarm is cancelled with the safety reset signal, however, the motor brake SBT incomplete signal (SBTNFMOM) remains ON.			
<b>V52</b>	<b>PLC safety stop is active</b>	0001	Axis name
<b>Details</b>			
A PLC input signal "Safe stop 1 request" or "Safe torque off request" is OFF (normal close). The screen displays the name of axis for which the said signal is OFF.			
<b>Remedy</b>			
♦Ensure the safety of the machine, and then turn ON either Safe stop 1 request signal or Safe torque off request signal.			
<b>V53</b>	<b>Warning on 24Hr continuous ON</b>	0001	Unit info
<b>Details</b>			
Output signal of the safety I/O unit has been kept ON for 24 hours or longer. Displays the information of the unit which is subject to the warning. bit0-31: Signal BIT			
<b>Remedy</b>			
♦Turn OFF the output signal concerned through the user safety sequence, or use the output OFF check function to make sure that the output signal turns OFF.			

---

<b>V54</b>	<b>Simple test mode is active</b>	0001
------------	-----------------------------------	------

---

**Details**

- Smart safety observation target axis (the parameters "#51101 SF\_Disable" = 0 / "#51301 SF\_SDisable" = 0) is defined as a hypothetical axis (the parameter "#51015 safe\_drv\_test" = 1). In this case some alarms fail to occur, thus avoid this setting while a drive unit is being connected.
- NC system is set to a simulation mode (the parameter "#1168 test" = 1 ). During this mode some alarms fail to occur, thus do not use this mode while a safety I/O unit is connected.

**Remedy**

- Connect MDS-E Series drive to all the axes subject to safety observation, set the parameter ("#51015 safe\_drv\_test" = 0) and then turn OFF and ON the power.
- Connect a safety I/O unit, set the parameter ("#1168 test" = 0) and then turn OFF and ON the power.

## Multi CPU Errors (A)

<b>A01</b>	<b>Power shutoff</b>	1000
	<b>Details</b>	
	<ul style="list-style-type: none"> <li>♦A momentary power failure has occurred.</li> <li>♦The power supply has been shut off.</li> </ul>	
	<b>Remedy</b>	
	<ul style="list-style-type: none"> <li>♦Check the power supply status.</li> </ul>	
<b>A01</b>	<b>ROM write count error</b>	1080
	<b>Details</b>	
	<ul style="list-style-type: none"> <li>♦The number of writes to the flash ROM (data memory, program memory, and system memory*1) exceeded 100000 times.</li> </ul>	
	<b>Remedy</b>	
	<ul style="list-style-type: none"> <li>♦Replace the CPU module.</li> </ul>	
<b>A01</b>	<b>Default gateway/GW IP address error</b>	1124
	<b>Details</b>	
	<ul style="list-style-type: none"> <li>♦The default gateway is not set correctly.</li> <li>♦The gateway IP address is not set correctly.</li> <li>♦The default gateway/gateway IP address (network address after the subnet mask) is different from that of the IP address of the own node.</li> </ul>	
	<b>Remedy</b>	
	<ul style="list-style-type: none"> <li>♦Correct the default gateway IP address.</li> <li>♦Set the same network address as that of the IP address.</li> </ul>	
<b>A01</b>	<b>Own node port number error</b>	1128
	<b>Details</b>	
	<ul style="list-style-type: none"> <li>♦The port number is incorrect.</li> </ul>	
	<b>Remedy</b>	
	<ul style="list-style-type: none"> <li>♦Correct the port number.</li> </ul>	
<b>A01</b>	<b>Open specification port num. error</b>	1129
	<b>Details</b>	
	<ul style="list-style-type: none"> <li>♦The port number setting value of the external device is incorrect.</li> </ul>	
	<b>Remedy</b>	
	<ul style="list-style-type: none"> <li>♦Correct the port number of the external device.</li> </ul>	
<b>A01</b>	<b>Specified IP address error</b>	112D
	<b>Details</b>	
	<ul style="list-style-type: none"> <li>♦The IP address setting value of the external device for the open processing is incorrect.</li> </ul>	
	<b>Remedy</b>	
	<ul style="list-style-type: none"> <li>♦Correct the IP addresses.</li> <li>♦Check if the class of the IP address is set to A/B/C.</li> </ul>	
<b>A01</b>	<b>Connection establishment failed</b>	112E
	<b>Details</b>	
	<ul style="list-style-type: none"> <li>♦A connection could not be established in the open processing.</li> </ul>	
	<b>Remedy</b>	
	<ul style="list-style-type: none"> <li>♦Check the operation of the external device.</li> <li>♦Check if the open processing has been performed in the external device.</li> <li>♦Correct the port number of the module, IP address/port number of the external device, and opening method.</li> <li>♦When the firewall is set in the external device, check if the access is permitted.</li> <li>♦Check if the Ethernet cable is disconnected.</li> </ul>	

<b>A01</b>	<b>Socket comm. response send error</b>	1133
<b>Details</b>		
<ul style="list-style-type: none"> <li>♦The response send failed during socket communications.</li> </ul>		
<b>Remedy</b>		
<ul style="list-style-type: none"> <li>♦Check the operation of the external device or switching hub.</li> <li>♦Since there may be congestion of packets on the line, send data after a certain period of time.</li> <li>♦Check if the connection cable is disconnected.</li> <li>♦Check that there is no connection failure with the switching hub.</li> </ul>		
<b>A01</b>	<b>TCP connection timeout</b>	1134
<b>Details</b>		
<ul style="list-style-type: none"> <li>♦A TCP ULP timeout error has occurred in the TCP/IP communication. (The external device does not send an ACK response.)</li> </ul>		
<b>Remedy</b>		
<ul style="list-style-type: none"> <li>♦Check the operation of the external device.</li> <li>♦Correct the TCP ULP timeout value.</li> <li>♦Since there may be congestion of packets on the line, send data after a certain period of time.</li> <li>♦Check if the connection cable is disconnected.</li> </ul>		
<b>A01</b>	<b>IP address error</b>	1152
<b>Details</b>		
<ul style="list-style-type: none"> <li>♦The IP address is not set correctly.</li> </ul>		
<b>Remedy</b>		
<ul style="list-style-type: none"> <li>♦Correct the IP addresses.</li> </ul>		
<b>A01</b>	<b>Connection number acquisition error</b>	1155
<b>Details</b>		
<ul style="list-style-type: none"> <li>♦The specified connection was already closed in TCP/IP communications.</li> <li>♦Open processing is not performed.</li> </ul>		
<b>Remedy</b>		
<ul style="list-style-type: none"> <li>♦Perform the open processing for the specified connection.</li> <li>♦Check if the open processing has been performed in the external device.</li> </ul>		
<b>A01</b>	<b>Receive buffer securement error</b>	1157
<b>Details</b>		
<ul style="list-style-type: none"> <li>♦The specified connection was already closed in UDP/IP communications.</li> <li>♦Open processing is not performed.</li> </ul>		
<b>Remedy</b>		
<ul style="list-style-type: none"> <li>♦Perform the open processing for the specified connection.</li> <li>♦Check if the open processing has been performed in the external device.</li> </ul>		
<b>A01</b>	<b>UDP/IP send failed</b>	1165
<b>Details</b>		
<ul style="list-style-type: none"> <li>♦Data was not sent correctly with UDP/IP.</li> </ul>		
<b>Remedy</b>		
<ul style="list-style-type: none"> <li>♦Check the settings for connection with the external device.</li> <li>♦Check the operation of the external device or switching hub.</li> <li>♦Since there may be congestion of packets on the line, send data after a certain period of time.</li> <li>♦Check if the connection cable is disconnected.</li> <li>♦Check that there is no connection failure with the switching hub.</li> <li>♦Execute the PING test, and if the test was completed with an error, take the corrective action.</li> </ul>		



<b>A01</b>	<b>TCP/IP send failed</b>	1166
<b>Details</b>		
<ul style="list-style-type: none"> <li>♦Data was not sent correctly with TCP/IP.</li> </ul>		
<b>Remedy</b>		
<ul style="list-style-type: none"> <li>♦Check the settings for connection with the external device.</li> <li>♦Check the operation of the external device or switching hub.</li> <li>♦Since there may be congestion of packets on the line, send data after a certain period of time.</li> <li>♦Check if the connection cable is disconnected.</li> <li>♦Check that there is no connection failure with the switching hub.</li> <li>♦Execute the PING test, and if the test was completed with an error, take the corrective action.</li> </ul>		
<b>A01</b>	<b>Unsend data send error</b>	1167
<b>Details</b>		
<ul style="list-style-type: none"> <li>♦Unsent data found, but could not be sent.</li> </ul>		
<b>Remedy</b>		
<ul style="list-style-type: none"> <li>♦Check the settings for connection with the external device.</li> <li>♦Check the operation of the external device or switching hub.</li> <li>♦Since there may be congestion of packets on the line, send data after a certain period of time.</li> <li>♦Check if the connection cable is disconnected.</li> <li>♦Check that there is no connection failure with the switching hub.</li> <li>♦Execute the PING test, and if the test was completed with an error, take the corrective action.</li> </ul>		
<b>A01</b>	<b>Module moderate error</b>	1200
<b>Details</b>		
<ul style="list-style-type: none"> <li>♦A moderate error has been notified from the intelligent function module connected.</li> </ul>		
<b>Remedy</b>		
<ul style="list-style-type: none"> <li>♦Check the detailed information (system configuration information) of the error by executing module diagnostics using the engineering tool, identify the error module, and eliminate the error cause.</li> </ul>		
<b>A01</b>	<b>Module moderate error</b>	1210
<b>Details</b>		
<ul style="list-style-type: none"> <li>♦An inter-module synchronous signal error has been notified from the intelligent function module connected.</li> </ul>		
<b>Remedy</b>		
<ul style="list-style-type: none"> <li>♦Check the detailed information (system configuration information) of the error by executing module diagnostics using the engineering tool, identify the error module, and eliminate the error cause.</li> </ul>		
<b>A01</b>	<b>Another CPU module moderate error</b>	1220
<b>Details</b>		
<ul style="list-style-type: none"> <li>♦A moderate error has been notified from another CPU module.</li> </ul>		
<b>Remedy</b>		
<ul style="list-style-type: none"> <li>♦Check the detailed information (system configuration information) of the error by executing module diagnostics using the engineering tool, identify the error module, and eliminate the error cause.</li> <li>♦Check the mounting status and reset status of other CPU modules.</li> </ul>		
<b>A01</b>	<b>Multiple CPU synchronization processing error</b>	1260
<b>Details</b>		
<ul style="list-style-type: none"> <li>♦The execution interval of a synchronous interrupt program has exceeded the set value.</li> <li>♦The run of a multiple CPU synchronous interrupt program (I45) has not finished within the multiple CPU fixed scan communication period.</li> </ul>		
<b>Remedy</b>		
<ul style="list-style-type: none"> <li>♦Check the detailed information (time information) in the module diagnostics to verify its value (time), and take the following actions:               <ol style="list-style-type: none"> <li>(1) Review the processing details on the multiple CPU synchronous interrupt program so that its processing is to be completed within the period specified in the fixed scan interval setting.</li> <li>(2) Set the period specified in the fixed scan interval setting to an appropriate value.</li> </ol> </li> </ul>		

<b>A01</b>	<b>Multiple CPU synchronization processing error</b>	1262
<b>Details</b>		
<ul style="list-style-type: none"> <li>♦The program run section of a synchronous interrupt program has been exceeded.</li> <li>♦The multiple CPU synchronous interrupt program (I45) has not been completed within the program run section.</li> </ul>		
<b>Remedy</b>		
<ul style="list-style-type: none"> <li>♦Check the detailed information (time information) in the module diagnostics to verify its value (time), and take the following actions:               <ol style="list-style-type: none"> <li>(1) Review the processing details on the multiple CPU synchronous interrupt program so that its processing is to be completed within the period specified in the fixed scan interval setting.</li> <li>(2) Set the period specified in the fixed scan interval setting to an appropriate value.</li> </ol> </li> </ul>		
<b>A01</b>	<b>Receive queue full</b>	1830
<b>Details</b>		
<ul style="list-style-type: none"> <li>♦Number of reception requests of transient transmission exceeded upper limit of simultaneously process-able requests.</li> </ul>		
<b>Remedy</b>		
<ul style="list-style-type: none"> <li>♦Lower the transient transmission usage frequency, and then perform again.</li> </ul>		
<b>A01</b>	<b>Receive processing error</b>	1831
<b>Details</b>		
<ul style="list-style-type: none"> <li>♦Transient reception failed.</li> </ul>		
<b>Remedy</b>		
<ul style="list-style-type: none"> <li>♦Lower the transient transmission usage frequency, and then perform again.</li> </ul>		
<b>A01</b>	<b>Transient data error</b>	1832
<b>Details</b>		
<ul style="list-style-type: none"> <li>♦Too many processings of transient transmission and cannot perform transient transmission.</li> </ul>		
<b>Remedy</b>		
<ul style="list-style-type: none"> <li>♦Correct the transient transmission execution count.</li> </ul>		
<b>A01</b>	<b>Constant scan time error</b>	1900
<b>Details</b>		
<ul style="list-style-type: none"> <li>♦The scan time exceeded the constant scan time set in the CPU parameters.</li> </ul>		
<b>Remedy</b>		
<ul style="list-style-type: none"> <li>♦Check and correct the constant scan time setting.</li> </ul>		
<b>A01</b>	<b>Safety master station error</b>	1A40
<b>Details</b>		
<ul style="list-style-type: none"> <li>♦Error information has been received from the master station in safety communication (CC-Link IE Field/CC-Link IE TSN).</li> </ul>		
<b>Remedy</b>		
<ul style="list-style-type: none"> <li>♦Execute the system monitor using the engineering tool to check the details of the error on the master station.</li> </ul>		
<b>A01</b>	<b>Safety master param. Mismatch</b>	1A50
<b>Details</b>		
<ul style="list-style-type: none"> <li>♦The parameters written to the NC and to the master station do not match.</li> </ul>		
<b>Remedy</b>		
<ul style="list-style-type: none"> <li>♦Make sure that the safety communication settings defined for the master station are consistent with the following parameters set in the NC: "#51702 SCN_Network No." (Safety communication network No.) and "#51703 SCN_Station No." (Safety communication network station No.).</li> <li>♦If the same error code is displayed again, the possible cause is a hardware failure of the data memory in the CPU module or the module performing the safety communication (CC-Link IE Field). Contact the service center.</li> </ul>		

<b>A01</b>	<b>Timeout in safety comm.</b>	1A60
<b>Details</b>		
<ul style="list-style-type: none"> <li>•A timeout error occurred for the response to the request when the safety communication connection was being established.</li> </ul>		
<b>Remedy</b>		
<ul style="list-style-type: none"> <li>•The possible cause is malfunction due to noise or cable failure. Check that there is no error in the transmission paths. Also check the distance of wires and cables and the grounding status of each device.</li> <li>•Check the safety refresh monitoring time set for the master station. (*)</li> <li>•Check that no online operation is being performed from a peripheral such as the engineering tool, or no program or parameter is being written to the master station.</li> <li>•The possible cause is a hardware failure of the module performing the safety communication (CC-Link IE Field/CC-Link IE TSN). Contact the service center.</li> </ul> <p>(*) For details, refer to the following manuals.</p> <ul style="list-style-type: none"> <li>- "MELSEC iQ-R CC-Link IE Field Network User's Manual (Application)"</li> <li>- "MELSEC iQ-R CC-Link TSN User's Manual (Application)".</li> </ul>		
<b>A01</b>	<b>Timeout in safety comm.</b>	1A61
<b>Details</b>		
<ul style="list-style-type: none"> <li>•A timeout error occurred during the safety refresh in safety communication (CC-Link IE Field/CC-Link IE TSN).</li> </ul>		
<b>Remedy</b>		
<ul style="list-style-type: none"> <li>•The possible cause is malfunction due to noise or cable failure. Check that there is no error in the transmission paths. Also check the distance of wires and cables and the grounding status of each device.</li> <li>•Check the safety refresh monitoring time set for the master station. (*)</li> <li>•Check that no online operation is being performed from a peripheral such as the engineering tool, or no program or parameter is being written to the master station.</li> <li>•The possible cause is a hardware failure of the module performing the safety communication (CC-Link IE Field/CC-Link IE TSN). Contact the service center.</li> </ul> <p>(*) For details, refer to the following manuals.</p> <ul style="list-style-type: none"> <li>- "MELSEC iQ-R CC-Link IE Field Network User's Manual (Application)"</li> <li>- "MELSEC iQ-R CC-Link TSN User's Manual (Application)"</li> </ul>		
<b>A01</b>	<b>Timeout in safety comm.</b>	1A62
<b>Details</b>		
<ul style="list-style-type: none"> <li>•A timeout error occurred during handling of an error in safety communication (CC-Link IE Field/CC-Link IE TSN).</li> </ul>		
<b>Remedy</b>		
<ul style="list-style-type: none"> <li>•The possible cause is malfunction due to noise or cable failure. Check that there is no error in the transmission paths. Also check the distance of wires and cables and the grounding status of each device.</li> <li>•Check the safety refresh monitoring time set for the master station. (*)</li> <li>•Check that no online operation is being performed from a peripheral such as the engineering tool, or no program or parameter is being written to the master station.</li> <li>•The possible cause is a hardware failure of the module performing the safety communication (CC-Link IE Field/CC-Link IE TSN). Contact the service center.</li> </ul> <p>(*) For details, refer to the following manuals.</p> <ul style="list-style-type: none"> <li>- "MELSEC iQ-R CC-Link IE Field Network User's Manual (Application)"</li> <li>- "MELSEC iQ-R CC-Link TSN User's Manual (Application)"</li> </ul>		

<b>A01</b>	<b>Timeout in safety comm.</b>	1A63
<b>Details</b>		
<ul style="list-style-type: none"> <li>♦A timeout error occurred for the safety refresh monitoring time in safety communication (CC-Link IE Field/CC-Link IE TSN).</li> </ul>		
<b>Remedy</b>		
<ul style="list-style-type: none"> <li>♦The possible cause is malfunction due to noise or cable failure. Check that there is no error in the transmission paths. Also check the distance of wires and cables and the grounding status of each device.</li> <li>♦Check the safety refresh monitoring time set for the master station. (*)</li> <li>♦Check that no online operation is being performed from a peripheral such as the engineering tool, or no program or parameter is being written to the master station.</li> <li>♦The possible cause is a hardware failure of the module performing the safety communication (CC-Link IE Field/CC-Link IE TSN). Contact the service center.</li> </ul> <p>(*) For details, refer to the following manuals.</p> <ul style="list-style-type: none"> <li>- "MELSEC iQ-R CC-Link IE Field Network User's Manual (Application)"</li> <li>- "MELSEC iQ-R CC-Link TSN User's Manual (Application)"</li> </ul>		
<b>A01</b>	<b>Timeout in safety comm.</b>	1A64
<b>Details</b>		
<ul style="list-style-type: none"> <li>♦The length of time that elapsed after the last data reception has exceeded the permissible value in safety communication (CC-Link IE Field/CC-Link IE TSN).</li> </ul>		
<b>Remedy</b>		
<ul style="list-style-type: none"> <li>♦The possible cause is malfunction due to noise or cable failure. Check that there is no error in the transmission paths. Also check the distance of wires and cables and the grounding status of each device.</li> <li>♦Check the parameter "#51704 SCN_SIM Time" (Safety communication network transmission interval to be monitored). When necessary, modify the setting and then restart the CNC.</li> <li>♦Check that no online operation is being performed from a peripheral such as the engineering tool, or no program or parameter is being written to the master station.</li> <li>♦The possible cause is a hardware failure of the module performing the safety communication (CC-Link IE Field/CC-Link IE TSN). Contact the service center.</li> </ul>		
<b>A01</b>	<b>Timeout in safety comm.</b>	1A65
<b>Details</b>		
<ul style="list-style-type: none"> <li>♦The length of time that elapsed after the last data reception in safety communication (CC-Link IE Field/CC-Link IE TSN) has exceeded the transmission interval monitoring time set for the master station, resulting in the timeout error.</li> </ul>		
<b>Remedy</b>		
<ul style="list-style-type: none"> <li>♦The possible cause is malfunction due to noise or cable failure. Check that there is no error in the transmission paths. Also check the distance of wires and cables and the grounding status of each device.</li> <li>♦Check the transmission interval monitoring time set for the master station. (*)</li> <li>♦Check that no online operation is being performed from a peripheral such as the engineering tool, or no program or parameter is being written to the master station.</li> <li>♦The possible cause is a hardware failure of the module performing the safety communication (CC-Link IE Field/CC-Link IE TSN). Contact the service center.</li> </ul> <p>(*) For details, refer to the following manuals.</p> <ul style="list-style-type: none"> <li>- "MELSEC iQ-R CC-Link IE Field Network User's Manual (Application)"</li> <li>- "MELSEC iQ-R CC-Link TSN User's Manual (Application)"</li> </ul>		
<b>A01</b>	<b>Safe comm. receipt data error</b>	1A70
<b>Details</b>		
<ul style="list-style-type: none"> <li>♦An error was detected in reception packets of safety communication.</li> </ul>		
<b>Remedy</b>		
<ul style="list-style-type: none"> <li>♦The possible cause is a hardware failure of the module performing the safety communication (CC-Link IE Field/CC-Link IE TSN). Contact the service center.</li> </ul>		
<b>A01</b>	<b>Safe comm. receipt data error</b>	1A71
<b>Details</b>		
<ul style="list-style-type: none"> <li>♦An error was detected in the user data of received packets of safety communication.</li> </ul>		
<b>Remedy</b>		
<ul style="list-style-type: none"> <li>♦The possible cause is a hardware failure of the module performing the safety communication (CC-Link IE Field/CC-Link IE TSN). Contact the service center.</li> </ul>		

<b>A01</b>	<b>Safe comm. receipt data error</b>	1A72
<b>Details</b>		
<ul style="list-style-type: none"> <li>♦An error was detected in the time stamp of received data of safety communication.</li> </ul>		
<b>Remedy</b>		
<ul style="list-style-type: none"> <li>♦The possible cause is a hardware failure of the module performing the safety communication (CC-Link IE Field/CC-Link IE TSN). Contact the service center.</li> </ul>		
<b>A01</b>	<b>Safe comm. receipt data error</b>	1A73
<b>Details</b>		
<ul style="list-style-type: none"> <li>♦An error was detected in the network number or the station number of received packets in safety communication.</li> </ul>		
<b>Remedy</b>		
<ul style="list-style-type: none"> <li>♦The possible cause is a hardware failure of the module performing the safety communication (CC-Link IE Field). Contact the service center.</li> </ul>		
<b>A01</b>	<b>Module configuration error</b>	2000
<b>Details</b>		
<ul style="list-style-type: none"> <li>♦The module type set in the system parameters ("I/O Assignment Setting") differs from that of the module actually mounted.</li> </ul>		
<b>Remedy</b>		
<ul style="list-style-type: none"> <li>♦Re-set the module type in the system parameters in accordance with the CPU module or intelligent function module actually mounted.</li> </ul>		
<b>A01</b>	<b>Module configuration error</b>	2001
<b>Details</b>		
<ul style="list-style-type: none"> <li>♦The I/O numbers set in the system parameters ("I/O Assignment Setting") are overlapping between modules.</li> </ul>		
<b>Remedy</b>		
<ul style="list-style-type: none"> <li>♦Re-set the I/O numbers in the system parameters in accordance with the intelligent function module or I/O module actually mounted.</li> </ul>		
<b>A01</b>	<b>Module configuration error</b>	2002
<b>Details</b>		
<ul style="list-style-type: none"> <li>♦The number of points assigned to the intelligent function module in the system parameters ("I/O Assignment Setting") is smaller than that of the module actually mounted.</li> </ul>		
<b>Remedy</b>		
<ul style="list-style-type: none"> <li>♦Re-set the number of points in the system parameters in accordance with the intelligent function module actually mounted.</li> </ul>		
<b>A01</b>	<b>Module configuration error</b>	2004
<b>Details</b>		
<ul style="list-style-type: none"> <li>♦Nine or more CC-Link IE Controller Network modules* are mounted in the entire system.</li> <li>♦The CC-Link IE built-in Ethernet interface module is included if the module is used as a CC-Link IE Controller Network module.</li> </ul>		
<b>Remedy</b>		
<ul style="list-style-type: none"> <li>♦Reduce the number of CC-Link IE Controller Network modules* to eight or less in the entire system.</li> <li>♦The CC-Link IE built-in Ethernet interface module is included if the module is used as a CC-Link IE Controller Network module.</li> </ul>		
<b>A01</b>	<b>Module configuration error</b>	2005
<b>Details</b>		
<ul style="list-style-type: none"> <li>♦Two or more interrupt modules (QI60) with no interrupt pointer setting are mounted.</li> <li>♦The interrupt pointer numbers are overlapping in the interrupt module (QI60) with no interrupt pointer setting and a module with an interrupt pointer setting.</li> </ul>		
<b>Remedy</b>		
<ul style="list-style-type: none"> <li>♦Mount only one QI60 in the entire system.</li> <li>♦Configure the interrupt pointer setting for the QI60.</li> <li>♦Correct the interrupt pointer setting.</li> </ul>		

<b>A01</b>	<b>Module configuration error</b>	2006
<b>Details</b>		
♦A module is mounted on the 65th slot or later.		
<b>Remedy</b>		
♦Remove the module mounted on the 65th slot or later.		
<b>A01</b>	<b>Module configuration error</b>	2007
<b>Details</b>		
♦A module is mounted on the slot whose number is later than that specified in the system parameters ("I/O Assignment Setting").		
<b>Remedy</b>		
♦Remove the module mounted on the slot whose number is later than that specified in the system parameters.		
<b>A01</b>	<b>Module configuration error</b>	2008
<b>Details</b>		
♦A module is mounted over or across the maximum number of I/O points (4096).		
<b>Remedy</b>		
♦Remove the module mounted over or across the maximum number of I/O points (4096).		
♦Replace the module mounted on the last slot to the one that does not exceed the maximum number of I/O points (4096).		
<b>A01</b>	<b>Module configuration error</b>	2009
<b>Details</b>		
♦There is no response from the I/O module or intelligent function module accessed.		
<b>Remedy</b>		
♦Check and correct the I/O assignment setting in the system parameters.		
♦The possible cause is a hardware failure of the I/O module or intelligent function module accessed. Please consult your local Mitsubishi representative.		
<b>A01</b>	<b>Module configuration error</b>	2020
<b>Details</b>		
♦There is a mounted module that is not supported, or there is a mounted module that is not supported by the network type (module model name) set in system parameters ("I/O Assignment Setting").		
<b>Remedy</b>		
♦Remove the unsupported module if any.		
♦Check whether modules are supported by the network type (module model name) set in the system parameters.		
♦If all the modules are supported, the possible cause is a hardware failure of the CPU module, base unit, I/O module, or intelligent function module. Please consult your local Mitsubishi representative.		
<b>A01</b>	<b>CPU module configuration error</b>	2021
<b>Details</b>		
♦In the multiple CPU system, the control CPU of the Q series intelligent function module incompatible with the multiple CPU system is set to other than CPU No.1.		
<b>Remedy</b>		
♦Replace the Q series intelligent function module with the one (function version B) compatible with the multiple CPU system.		
♦Set the control CPU of the Q series intelligent function module incompatible with the multiple CPU system to CPU No.1.		

<b>A01</b>	<b>CPU module configuration error</b>	2040
<b>Details</b>		
<ul style="list-style-type: none"> <li>•The number of CPU modules set in the system parameters ("I/O Assignment Setting") differs from the number of CPU modules actually mounted.</li> <li>•The CPU module is mounted on the slot different from the one specified in the system parameters (I/O assignment setting).</li> </ul>		
<b>Remedy</b>		
<ul style="list-style-type: none"> <li>•Correctly set the number of CPU modules (including the empty setting) in the system parameters in accordance with the number of CPU modules actually mounted.</li> <li>•Correctly set the system parameters so that the setting and actual CPU module mounting status will be the same.</li> </ul>		
<b>A01</b>	<b>CPU module configuration error</b>	2041
<b>Details</b>		
<ul style="list-style-type: none"> <li>•The CPU module is not mounted on the slot that is set for the CPU module in the system parameters ("I/O Assignment Setting").</li> <li>•The CPU module is mounted on the slot that is set for empty in the system parameters ("I/O Assignment Setting").</li> <li>•An I/O module or intelligent function module is mounted between the CPU modules.</li> </ul>		
<b>Remedy</b>		
<ul style="list-style-type: none"> <li>•Correctly set the number of CPU modules (including the empty setting) in the system parameters in accordance with the number of CPU modules actually mounted.</li> <li>•Remove the I/O module or intelligent function module mounted between the CPU modules.</li> </ul>		
<b>A01</b>	<b>CPU module configuration error</b>	2043
<b>Details</b>		
<ul style="list-style-type: none"> <li>•The CPU module is mounted on the inapplicable slot.</li> </ul>		
<b>Remedy</b>		
<ul style="list-style-type: none"> <li>•Mount the CPU module on the applicable slot (CPU slot or I/O slot 0 to 6).</li> <li>•Remove the CPU module from the inapplicable slot.</li> </ul>		
<b>A01</b>	<b>CPU module configuration error</b>	2044
<b>Details</b>		
<ul style="list-style-type: none"> <li>•The host CPU No. set in the system parameters ("I/O Assignment Setting") differs from the one determined by the mounting position of the CPU module.</li> </ul>		
<b>Remedy</b>		
<ul style="list-style-type: none"> <li>•Re-set the host CPU No. in the system parameters in accordance with the mounting position of the CPU module.</li> </ul>		
<b>A01</b>	<b>CPU module configuration error</b>	2050
<b>Details</b>		
<ul style="list-style-type: none"> <li>•An unsupported CPU module is mounted.</li> </ul>		
<b>Remedy</b>		
<ul style="list-style-type: none"> <li>•Remove the unsupported CPU module. If all the CPU modules are supported, the possible cause is a hardware failure of the CPU module or base unit. Please consult your local Mitsubishi representative.</li> </ul>		
<b>A01</b>	<b>Base unit A configuration error</b>	2060
<b>Details</b>		
<ul style="list-style-type: none"> <li>•Eight or more extension base units are connected.</li> </ul>		
<b>Remedy</b>		
<ul style="list-style-type: none"> <li>•Reduce the number of extension base units to seven or less.</li> </ul>		

<b>A01</b>	<b>Base unit A configuration error</b>	2061
<b>Details</b>		
<ul style="list-style-type: none"> <li>♦Any of the following base units is connected: QA1S3 B, QA1S5 B/QA1S6 B, QA6 B, QA6ADP+A5 B/A6 B, or QA1S6ADP+A1S5 B/A1S6 B.</li> </ul>		
<b>Remedy</b>		
<ul style="list-style-type: none"> <li>♦Remove the inapplicable base unit: QA1S3 B,QA1S5 B/QA1S6 B, QA6 B, QA6ADP+A5 B/A6 B B, and QA1S6ADP+A1S5 B/A1S6 B.</li> </ul>		
<b>A01</b>	<b>Base unit A configuration error</b>	2063
<b>Details</b>		
<ul style="list-style-type: none"> <li>♦Extension base unit levels are overlapping.</li> </ul>		
<b>Remedy</b>		
<ul style="list-style-type: none"> <li>♦Check and correct the level setting of the extension base units.</li> </ul>		
<b>A01</b>	<b>Base unit A configuration error</b>	2070
<b>Details</b>		
<ul style="list-style-type: none"> <li>♦An unsupported base unit is connected.</li> <li>♦A GOT is bus-connected to the Q series extension base unit.</li> </ul>		
<b>Remedy</b>		
<ul style="list-style-type: none"> <li>♦Disconnect the unsupported base unit. If all the base units are supported, the possible cause is a hardware failure of the CPU module or base unit. Please consult your local Mitsubishi representative.</li> <li>♦Disconnect the GOT bus-connected to the Q series extension base unit.</li> </ul>		
<b>A01</b>	<b>Inter-module synch configure error</b>	2080
<b>Details</b>		
<ul style="list-style-type: none"> <li>♦An inter-module synchronization signal error has been detected.</li> </ul>		
<b>Remedy</b>		
<ul style="list-style-type: none"> <li>♦The possible cause is a hardware failure of the CPU module, base unit, or module (I/O module or intelligent function module) connected. Please consult your local Mitsubishi representative.</li> </ul>		
<b>A01</b>	<b>Module unrecognized</b>	20E0
<b>Details</b>		
<ul style="list-style-type: none"> <li>♦A module that the CPU module cannot recognize is mounted.</li> <li>♦The module cannot be recognized because the control CPU setting of the system parameter setting differs from that of other CPU modules in the multiple CPU system.</li> </ul>		
<b>Remedy</b>		
<ul style="list-style-type: none"> <li>♦Mount only applicable modules.</li> <li>♦Correct the system parameter settings for the CPU No.2 and later. The settings need to be the same between all the CPU modules.</li> <li>♦The possible cause is a hardware failure of the I/O module or intelligent function module accessed. Please consult your local Mitsubishi representative.</li> </ul>		
<b>A01</b>	<b>IP address duplication error</b>	2160
<b>Details</b>		
<ul style="list-style-type: none"> <li>♦Overlapping IP addresses have been detected.</li> </ul>		
<b>Remedy</b>		
<ul style="list-style-type: none"> <li>♦Check and correct the IP addresses.</li> </ul>		
<b>A01</b>	<b>Invalid file</b>	2180
<b>Details</b>		
<ul style="list-style-type: none"> <li>♦An invalid file has been detected.</li> </ul>		
<b>Remedy</b>		
<ul style="list-style-type: none"> <li>♦Check the detailed information (drive/file information) of the error by executing module diagnostics using the engineering tool, select the correct file name, and write the specified file to the CPU module. If the same error code is displayed again, the possible cause is a hardware failure of the CPU module. Please consult your local Mitsubishi representative.</li> </ul>		



<b>A01</b>	<b>File specification error</b>	21A1
<b>Details</b>		
<ul style="list-style-type: none"> <li>•The file specified in parameter cannot be created.</li> </ul>		
<b>Remedy</b>		
<ul style="list-style-type: none"> <li>•Check the detailed information (parameter information) of the error by executing module diagnostics using the engineering tool, and correct the name and size of the file corresponding to the displayed number.</li> <li>•Check the detailed information (drive/file information) of the error by executing module diagnostics using the engineering tool, and take either of the following action. <ul style="list-style-type: none"> <li>(1) Format the corresponding drive.</li> <li>(2) Delete unnecessary files on the corresponding drive to increase free space.</li> <li>(3) Unlock the corresponding drive if it is locked.</li> </ul> </li> </ul>		
<b>A01</b>	<b>File specification error</b>	21A2
<b>Details</b>		
<ul style="list-style-type: none"> <li>•The CPU module model set to the file using the engineering tool differs from that of the CPU module actually mounted.</li> </ul>		
<b>Remedy</b>		
<ul style="list-style-type: none"> <li>•Check the detailed information (drive/file information) of the error by executing module diagnostics using the engineering tool, and correct the CPU module model set to the file in accordance with that of the CPU module actually mounted.</li> </ul>		
<b>A01</b>	<b>Parameter A error</b>	2200
<b>Details</b>		
<ul style="list-style-type: none"> <li>•The system parameter file and CPU parameter file do not exist.</li> <li>•The memory card parameter file or module extension parameter file stored in the memory card cannot be accessed because the memory card is disable by SM606 (SD memory card forced disable instruction).</li> </ul>		
<b>Remedy</b>		
<ul style="list-style-type: none"> <li>•Write the system parameter file and CPU parameter file to the CPU module.</li> <li>•Turn off SM606. (Cancel the disabled state.)</li> </ul>		
<b>A01</b>	<b>Parameter A error</b>	2220
<b>Details</b>		
<ul style="list-style-type: none"> <li>•An error was detected in the consistency check of the safety connection parameters.</li> </ul>		
<b>Remedy</b>		
<ul style="list-style-type: none"> <li>•Check the following parameters set in the CNC. When necessary, modify the setting and restart the CNC. <ul style="list-style-type: none"> <li>- "#51702 SCN_Network No." (Safety communication network No.)</li> <li>- "#51703 SCN_Station No." (Safety communication network station No.)</li> <li>- "#51705 SCN_IETSN_MA IP" (CC-Link IE TSN master station IP address)</li> <li>- "#51706 SCN_IETSN_OWN IP" (CC-Link IE TSN own station IP address)</li> </ul> </li> <li>•If the same error code is displayed again, the possible cause is a hardware failure of the data memory in the CPU module, the memory card, the I/O module, the CC-Link IE Field network module, or the CC-Link IE TSN module. Contact the service center.</li> </ul>		
<b>A01</b>	<b>Parameter A error</b>	2221
<b>Details</b>		
<ul style="list-style-type: none"> <li>•The set value is out of range.</li> </ul>		
<b>Remedy</b>		
<ul style="list-style-type: none"> <li>•Check the following parameters set in the CNC. When necessary, modify the setting and restart the CNC. <ul style="list-style-type: none"> <li>- "#51702 SCN_Network No." (Safety communication network No.)</li> <li>- "#51703 SCN_Station No." (Safety communication network station No.)</li> <li>- "#51705 SCN_IETSN_MA IP" (CC-Link IE TSN master station IP address)</li> <li>- "#51706 SCN_IETSN_OWN IP" (CC-Link IE TSN own station IP address)</li> </ul> </li> <li>•If the same error code is displayed again, the possible cause is a hardware failure of the data memory in the CPU module, the memory card, the I/O module, the CC-Link IE Field network module, or the CC-Link IE TSN module. Contact the service center.</li> </ul>		

A01	Parameter A error	2222
<b>Details</b>		
<ul style="list-style-type: none"> <li>◆Use of the function that is not supported by the module is enabled in parameter.</li> </ul>		
<b>Remedy</b>		
<ul style="list-style-type: none"> <li>◆Check the detailed information (parameter information) of the error by executing module diagnostics using the engineering tool, and correct the parameter setting corresponding to the displayed number. If the same error code is displayed again, the possible cause is a hardware failure of the data memory in the CPU module, the memory card, or the module (I/O module or intelligent function module) connected. Please consult your local Mitsubishi representative.</li> </ul>		
A01	Parameter A error	2224
<b>Details</b>		
<ul style="list-style-type: none"> <li>◆A memory area cannot be ensured.</li> </ul>		
<b>Remedy</b>		
<ul style="list-style-type: none"> <li>◆Check the detailed information (parameter information) of the error by executing module diagnostics using the engineering tool, display the error-detected area by clicking the [Error Jump] button, and increase the capacity of the area. (If the capacity of the area cannot be increased, decrease the capacity of other areas.)</li> <li>◆Reduce the number of labels or local devices used.</li> </ul>		
A01	Parameter A error	2225
<b>Details</b>		
<ul style="list-style-type: none"> <li>◆The CPU module model set to the project using the engineering tool differs from that of the CPU module actually mounted.</li> <li>◆The operation set in the memory card parameters cannot be performed. (The boot function cannot be executed.)</li> </ul>		
<b>Remedy</b>		
<ul style="list-style-type: none"> <li>◆Correct the CPU module model set to the project in accordance with the CPU module actually mounted.</li> <li>◆Delete the memory card parameter settings.</li> <li>◆Remove the memory card so that the operation set in the memory card parameters will not be performed. (Do not execute the boot operation.)</li> </ul>		
A01	Parameter error (module)	2240
<b>Details</b>		
<ul style="list-style-type: none"> <li>◆In the multiple CPU system, the I/O module or intelligent function module controlled by another CPU module is specified in the module parameters.</li> </ul>		
<b>Remedy</b>		
<ul style="list-style-type: none"> <li>◆Check the detailed information (parameter information) of the error by executing module diagnostics using the engineering tool, and correct the parameter setting corresponding to the displayed number. If the same error code is displayed again, the possible cause is a hardware failure of the data memory in the CPU module or the module (I/O module or intelligent function module) connected. Please consult your local Mitsubishi representative.</li> </ul>		
A01	Parameter error (module)	2241
<b>Details</b>		
<ul style="list-style-type: none"> <li>◆The target module is not mounted on the slot specified by the parameter.</li> </ul>		
<b>Remedy</b>		
<ul style="list-style-type: none"> <li>◆Check the following parameter set in the CNC: "#51701 SCN_Slot No." (Safety communication network slot No.). When necessary, modify the setting and restart the CNC.</li> <li>◆If the same error code is displayed again, the possible cause is a hardware failure of the data memory in the CPU module, the I/O module, the CC-Link IE Field network module, or the CC-Link IE TSN module. Contact the service center.</li> </ul>		

<b>A01</b>	<b>Parameter error (module)</b>	2242
<b>Details</b>		
<ul style="list-style-type: none"> <li>•The CC-Link IE Field network module has detected a module parameter error.</li> </ul>		
<b>Remedy</b>		
<ul style="list-style-type: none"> <li>•Check the following parameters set in the CNC. When necessary, modify the setting and restart the CNC. <ul style="list-style-type: none"> <li>- "#51702 SCN_Network No." (Safety communication network No.)</li> <li>- "#51703 SCN_Station No." (Safety communication network station No.)</li> <li>- "#51705 SCN_IETSN_MA IP" (CC-Link IE TSN master station IP address)</li> <li>- "#51706 SCN_IETSN_OWN IP" (CC-Link IE TSN own station IP address)</li> </ul> </li> <li>•If the same error code is displayed again, the possible cause is a hardware failure of the data memory in the CPU module, the CC-Link IE Field network module, or the CC-Link IE TSN module. Contact the service center.</li> </ul>		
<b>A01</b>	<b>Parameter error (network)</b>	2260
<b>Details</b>		
<ul style="list-style-type: none"> <li>•Network numbers are overlapping.</li> </ul>		
<b>Remedy</b>		
<ul style="list-style-type: none"> <li>•Check the detailed information (parameter information) of the error by executing module diagnostics using the engineering tool, and correct the parameter setting corresponding to the displayed number. If the same error code is displayed again, the possible cause is a hardware failure of the data memory in the CPU module or the intelligent function module connected. Please consult your local Mitsubishi representative.</li> </ul>		
<b>A01</b>	<b>Parameter error (network)</b>	2261
<b>Details</b>		
<ul style="list-style-type: none"> <li>•Different network types (CC IE Control extended mode/normal mode) are set between the control station and the normal station.</li> </ul>		
<b>Remedy</b>		
<ul style="list-style-type: none"> <li>•Check the detailed information (parameter information) of the error by executing module diagnostics using the engineering tool, and correct the parameter setting corresponding to the displayed number. If the same error code is displayed again, the possible cause is a hardware failure of the data memory in the CPU module or the intelligent function module connected. Please consult your local Mitsubishi representative.</li> </ul>		
<b>A01</b>	<b>Parameter error (network)</b>	2262
<b>Details</b>		
<ul style="list-style-type: none"> <li>•The station type set in the module parameters differs that of the module actually mounted.</li> </ul>		
<b>Remedy</b>		
<ul style="list-style-type: none"> <li>•Check the detailed information (parameter information) of the error by executing module diagnostics using the engineering tool, and correct the parameter setting corresponding to the displayed number. If the same error code is displayed again, the possible cause is a hardware failure of the data memory in the CPU module or the intelligent function module connected. Please consult your local Mitsubishi representative.</li> </ul>		
<b>A01</b>	<b>Parameter error (network)</b>	2263
<b>Details</b>		
<ul style="list-style-type: none"> <li>•Even though the CC-Link IE module or MELSECNET/H network module is mounted, a different CC-Link IE module or MELSECNET/H network module is set in the system parameters ("I/O Assignment Setting"), or CC-Link IE module or MELSECNET/H network module parameters have not been set.</li> </ul>		
<b>Remedy</b>		
<ul style="list-style-type: none"> <li>•Set the system parameters and module parameters. If the same error code is displayed again, the possible cause is a hardware failure of the data memory in the CPU module or the intelligent function module connected. Please consult your local Mitsubishi representative.</li> </ul>		

<b>A01</b>	<b>Parameter error (refresh)</b>	2280
<b>Details</b>		
<ul style="list-style-type: none"> <li>♦The refresh setting is not set correctly. (Data were refreshed exceeding the file register capacity.)</li> <li>♦The refresh settings (number of points) are different from those of other numbered CPU modules.</li> </ul>		
<b>Remedy</b>		
<ul style="list-style-type: none"> <li>♦Check the detailed information (parameter information) of the error by executing module diagnostics using the engineering tool, and correct the parameter setting corresponding to the displayed number so that the data are refreshed within the specified device range. (Take any of the following actions: increase the number of file register points, create a file register file having a capacity for all of the target data to be refreshed, or reduce the refresh device range.)</li> <li>♦Rewrite the refresh settings (number of points) in the CPU parameters for all the CPU modules. (Use the same number of points in the refresh settings for all the CPU modules.)</li> </ul>		
<b>A01</b>	<b>Parameter error (refresh)</b>	2281
<b>Details</b>		
<ul style="list-style-type: none"> <li>♦A device that cannot be used as a refresh device is specified.</li> </ul>		
<b>Remedy</b>		
<ul style="list-style-type: none"> <li>♦Check the detailed information (parameter information) of the error by executing module diagnostics using the engineering tool, and correct the parameter setting corresponding to the displayed number.</li> </ul>		
<b>A01</b>	<b>Parameter error (refresh)</b>	2282
<b>Details</b>		
<ul style="list-style-type: none"> <li>♦The number of specified refresh points is invalid.</li> </ul>		
<b>Remedy</b>		
<ul style="list-style-type: none"> <li>♦Check the detailed information (parameter information) of the error by executing module diagnostics using the engineering tool, and correct the parameter setting corresponding to the displayed number.</li> </ul>		
<b>A01</b>	<b>Parameter error (refresh)</b>	2283
<b>Details</b>		
<ul style="list-style-type: none"> <li>♦The total number of refresh points exceeded the maximum limit.</li> </ul>		
<b>Remedy</b>		
<ul style="list-style-type: none"> <li>♦Check the detailed information (parameter information) of the error by executing module diagnostics using the engineering tool, and correct the parameter setting corresponding to the displayed number.</li> </ul>		
<b>A01</b>	<b>Parameter verification error</b>	22E0
<b>Details</b>		
<ul style="list-style-type: none"> <li>♦In the multiple CPU system, the system parameter settings of the host CPU module differ from those of other CPU modules.</li> <li>♦In the multiple CPU system, the system parameter settings are overwritten only to the host CPU module, and the settings differ from those of other CPU modules.</li> </ul>		
<b>Remedy</b>		
<ul style="list-style-type: none"> <li>♦Check the detailed information (parameter information) of the error by executing module diagnostics using the engineering tool, and correct the system parameter settings corresponding to the displayed number for the CPU No.2 and later. The settings need to be the same between all the CPU modules. (The module synchronization setting and fixed scan communication setting need to be the same between the CPU modules that use these functions.)</li> <li>♦When the system parameter settings are changed, update the settings of all the CPU modules connected. (The system parameter settings must be same in all the CPU modules.)</li> </ul>		
<b>A01</b>	<b>Security key authentication error</b>	2300
<b>Details</b>		
<ul style="list-style-type: none"> <li>♦The security key set to the program does not match the one registered to the CPU module (or extended SRAM cassette).</li> </ul>		
<b>Remedy</b>		
<ul style="list-style-type: none"> <li>♦Check and correct the security key setting.</li> </ul>		

<b>A01</b>	<b>Security key authentication error</b>	2301
<b>Details</b>		
<ul style="list-style-type: none"> <li>•The security key is set to the program, but it is not registered to the CPU module (or extended SRAM cassette).</li> </ul>		
<b>Remedy</b>		
<ul style="list-style-type: none"> <li>•Check and correct the security key setting.</li> </ul>		
<b>A01</b>	<b>Security key authentication error</b>	2302
<b>Details</b>		
<ul style="list-style-type: none"> <li>•The security key set to the file is corrupted and does not match the one registered to the CPU module.</li> <li>•The security key registered to the CPU module is corrupted and does not match the one set to the file.</li> </ul>		
<b>Remedy</b>		
<ul style="list-style-type: none"> <li>•Write the file to the CPU module again. If the same error code is displayed again, the possible cause is a hardware failure of the CPU module. Please consult your local Mitsubishi representative.</li> </ul>		
<b>A01</b>	<b>Security key authentication error</b>	2303
<b>Details</b>		
<ul style="list-style-type: none"> <li>•The security key is registered to the CPU module and extended SRAM cassette.</li> </ul>		
<b>Remedy</b>		
<ul style="list-style-type: none"> <li>•Check and correct the security key setting.</li> </ul>		
<b>A01</b>	<b>Remote A password setting error</b>	2320
<b>Details</b>		
<ul style="list-style-type: none"> <li>•The start I/O number of the remote password target module is set to other than 0H to 0FF0H.</li> <li>•There is a problem on the slot specified by the start I/O number of the remote password setting. <ul style="list-style-type: none"> <li>(1) No module is mounted.</li> <li>(2) The mounted intelligent function module does not support the remote password setting.</li> </ul> </li> </ul>		
<b>Remedy</b>		
<ul style="list-style-type: none"> <li>•Set the start I/O number of the remote password target module within the range 0H to 0FF0H.</li> <li>•On the specified slot, mount an intelligent function module that supports the remote password setting.</li> </ul>		
<b>A01</b>	<b>Remote A password setting error</b>	2321
<b>Details</b>		
<ul style="list-style-type: none"> <li>•In the multiple CPU system, the module controlled by another CPU module is specified by the start I/O number of the remote password setting.</li> </ul>		
<b>Remedy</b>		
<ul style="list-style-type: none"> <li>•Check and correct the remote password setting.</li> </ul>		
<b>A01</b>	<b>Module verification error</b>	2400
<b>Details</b>		
<ul style="list-style-type: none"> <li>•The module information at power-on differs from the information of modules actually mounted.</li> <li>•The I/O module or intelligent function module is not mounted properly or was removed during operation.</li> </ul>		
<b>Remedy</b>		
<ul style="list-style-type: none"> <li>•Check the detailed information (system configuration information) of the error by executing module diagnostics using the engineering tool, and check the module corresponding to the displayed number.</li> </ul>		
<b>A01</b>	<b>Module verification error</b>	2401
<b>Details</b>		
<ul style="list-style-type: none"> <li>•A CPU module, I/O module, or intelligent function module was mounted on the base unit during operation.</li> </ul>		
<b>Remedy</b>		
<ul style="list-style-type: none"> <li>•Check the detailed information (system configuration information) of the error by executing module diagnostics using the engineering tool, and check the module corresponding to the displayed number.</li> <li>•Do not mount a CPU module, I/O module, nor intelligent function module during operation.</li> </ul>		

<b>A01</b>	<b>Fuse blown error</b>	2420
<b>Details</b>		
<ul style="list-style-type: none"> <li>♦The output module with a blown fuse has been detected.</li> </ul>		
<b>Remedy</b>		
<ul style="list-style-type: none"> <li>♦Check the FUSE LED of each output module, and replace the one with the FUSE LED on.</li> <li>♦Check the detailed information (system configuration information) of the error by executing module diagnostics using the engineering tool, and replace the module corresponding to the displayed number.</li> </ul>		
<b>A01</b>	<b>Controlled module major error</b>	2440
<b>Details</b>		
<ul style="list-style-type: none"> <li>♦An error was detected in the I/O module or the CNC-controlled CC-Link IE Field network module during the initial processing.</li> </ul>		
<b>Remedy</b>		
<ul style="list-style-type: none"> <li>♦Take measures to reduce noise.</li> <li>♦The possible cause is a hardware failure of the error module. Contact the service center.</li> </ul>		
<b>A01</b>	<b>Controlled module major error</b>	2442
<b>Details</b>		
<ul style="list-style-type: none"> <li>♦An error was detected in the I/O module or the CNC-controlled CC-Link IE Field network module during the run-time processing.</li> </ul>		
<b>Remedy</b>		
<ul style="list-style-type: none"> <li>♦Take measures to reduce noise.</li> <li>♦The possible cause is a hardware failure of the error module. Contact the service center.</li> </ul>		
<b>A01</b>	<b>Module major error</b>	2443
<b>Details</b>		
<ul style="list-style-type: none"> <li>♦An error has been detected in the I/O module or intelligent function module.</li> </ul>		
<b>Remedy</b>		
<ul style="list-style-type: none"> <li>♦The possible cause is a hardware failure of the error module. Please consult your local Mitsubishi representative.</li> </ul>		
<b>A01</b>	<b>Controlled module major error</b>	2450
<b>Details</b>		
<ul style="list-style-type: none"> <li>♦Notification of major error occurrence was issued from the CNC-controlled CC-Link IE Field network module.</li> <li>♦The I/O module or the CNC-controlled CC-Link IE Field network module is not mounted properly or was removed during operation.</li> </ul>		
<b>Remedy</b>		
<ul style="list-style-type: none"> <li>♦Take measures to reduce noise.</li> <li>♦Check the connection status of the extension cable.</li> <li>♦Check the mounting status of the I/O module or the CC-Link IE Field network module.</li> <li>♦If the same error code is displayed again, the possible cause is a hardware failure of the error module. Contact the service center.</li> </ul>		
<b>A01</b>	<b>Another CPU module major error</b>	2460
<b>Details</b>		
<ul style="list-style-type: none"> <li>♦An error has been detected in another CPU module during the initial processing.</li> </ul>		
<b>Remedy</b>		
<ul style="list-style-type: none"> <li>♦Reset the CPU module, and run it again. If the same error code is displayed again, the possible cause is a hardware failure of the host CPU module or another CPU module where the error has been detected. Please consult your local Mitsubishi representative.</li> </ul>		

<b>A01</b>	<b>Another CPU module major error</b>	2463
<b>Details</b>		
<ul style="list-style-type: none"> <li>•An error has been detected in another CPU module.</li> </ul>		
<b>Remedy</b>		
<ul style="list-style-type: none"> <li>•Reset the CPU module, and run it again. If the same error code is displayed again, the possible cause is a hardware failure of the host CPU module or another CPU module where the error has been detected. Please consult your local Mitsubishi representative.</li> </ul>		
<b>A01</b>	<b>Another CPU module major error</b>	2470
<b>Details</b>		
<ul style="list-style-type: none"> <li>•A major error has been notified from another CPU module.</li> </ul>		
<b>Remedy</b>		
<ul style="list-style-type: none"> <li>•Reset the CPU module, and run it again. If the same error code is displayed again, the possible cause is a hardware failure of the host CPU module or another CPU module where the error has been detected. Please consult your local Mitsubishi representative.</li> </ul>		
<b>A01</b>	<b>Multiple CPU error</b>	2480
<b>Details</b>		
<ul style="list-style-type: none"> <li>•In the multiple CPU system, an error has been detected in the CPU module where "Stop" is set in the operation mode setting parameter.</li> <li>•Any CPU module other than CPU No.1 is mounted in the inapplicable slot. (An error occurs in the CPU module mounted in the inapplicable slot.)</li> </ul>		
<b>Remedy</b>		
<ul style="list-style-type: none"> <li>•Check the detailed information (system configuration information) of the error by executing module diagnostics using the engineering tool, identify the error CPU module, and eliminate the error cause.</li> <li>•Remove the CPU module from the inapplicable slot.</li> </ul>		
<b>A01</b>	<b>Multiple CPU error</b>	2481
<b>Details</b>		
<ul style="list-style-type: none"> <li>•In the multiple CPU system, any CPU module other than CPU No.1 was disconnected from the base unit during operation. Or, any CPU module other than CPU No.1 was reset.</li> </ul>		
<b>Remedy</b>		
<ul style="list-style-type: none"> <li>•Check the mounting status and reset status of the CPU modules other than CPU No.1.</li> </ul>		
<b>A01</b>	<b>System bus error</b>	24C0
<b>Details</b>		
<ul style="list-style-type: none"> <li>•An error was detected on the system bus.</li> </ul>		
<b>Remedy</b>		
<ul style="list-style-type: none"> <li>•Take measures to reduce noise.</li> <li>•If the same error code is displayed again, the possible cause is a hardware failure of the CPU module, the I/O module, the CC-Link IE Field network module, the CC-Link IE TSN module, the base unit or the extension cable. Contact the service center.</li> </ul>		
<b>A01</b>	<b>System bus error</b>	24C1
<b>Details</b>		
<ul style="list-style-type: none"> <li>•An error was detected on the system bus.</li> </ul>		
<b>Remedy</b>		
<ul style="list-style-type: none"> <li>•Take measures to reduce noise.</li> <li>•If the same error code is displayed again, the possible cause is a hardware failure of the CPU module, the I/O module, the CC-Link IE Field network module, the CC-Link IE TSN module, the base unit or the extension cable. Contact the service center.</li> </ul>		

<b>A01</b>	<b>System bus error</b>	<b>24C2</b>
<b>Details</b>		
<ul style="list-style-type: none"> <li>♦The I/O module, the CC-Link IE Field network module or the CC-Link IE TSN module is not mounted properly or was removed during operation.</li> <li>♦An error was detected on the system bus.</li> </ul>		
<b>Remedy</b>		
<ul style="list-style-type: none"> <li>♦Check the connection status of the extension cable.</li> <li>♦Take measures to reduce noise.</li> <li>♦Check the mounting status of the I/O module, the CC-Link IE Field network module or the CC-Link IE TSN module.</li> <li>♦If the same error code is displayed again, the possible cause is a hardware failure of the CPU module, the I/O module, the CC-Link IE Field network module, the CC-Link IE TSN module, the base unit or the extension cable. Contact the service center.</li> </ul>		
<b>A01</b>	<b>System bus error</b>	<b>24C3</b>
<b>Details</b>		
<ul style="list-style-type: none"> <li>♦An error was detected on the system bus.</li> </ul>		
<b>Remedy</b>		
<ul style="list-style-type: none"> <li>♦Take measures to reduce noise.</li> <li>♦If the same error code is displayed again, the possible cause is a hardware failure of the CPU module, the I/O module, the CC-Link IE Field network module, the CC-Link IE TSN module, the base unit or the extension cable. Contact the service center.</li> </ul>		
<b>A01</b>	<b>System bus error</b>	<b>24C4</b>
<b>Details</b>		
<ul style="list-style-type: none"> <li>♦An error was detected on the system bus.</li> </ul>		
<b>Remedy</b>		
<ul style="list-style-type: none"> <li>♦Take measures to reduce noise.</li> <li>♦If the same error code is displayed again, the possible cause is a hardware failure of the CPU module, the I/O module, the CC-Link IE Field network module, the CC-Link IE TSN module, the base unit or the extension cable. Contact the service center.</li> </ul>		
<b>A01</b>	<b>System bus error</b>	<b>24C5</b>
<b>Details</b>		
<ul style="list-style-type: none"> <li>♦An error was detected on the system bus.</li> </ul>		
<b>Remedy</b>		
<ul style="list-style-type: none"> <li>♦Take measures to reduce noise.</li> <li>♦Reset the CPU module, and run it again. If the same error code is displayed again, the possible cause is a hardware failure of the base unit, extension cable, or module (I/O module or intelligent function module) connected. Please consult your local Mitsubishi representative.</li> </ul>		
<b>A01</b>	<b>System bus error</b>	<b>24C6</b>
<b>Details</b>		
<ul style="list-style-type: none"> <li>♦An error was detected on the system bus.</li> </ul>		
<b>Remedy</b>		
<ul style="list-style-type: none"> <li>♦Take measures to reduce noise.</li> <li>♦If the same error code is displayed again, the possible cause is a hardware failure of the CPU module, the I/O module, the CC-Link IE Field network module, the CC-Link IE TSN module, the base unit or the extension cable. Contact the service center.</li> </ul>		
<b>A01</b>	<b>System bus error</b>	<b>24C8</b>
<b>Details</b>		
<ul style="list-style-type: none"> <li>♦An error was detected on the system bus.</li> </ul>		
<b>Remedy</b>		
<ul style="list-style-type: none"> <li>♦Take measures to reduce noise.</li> <li>♦Reset the CPU module, and run it again. If the same error code is displayed again, the possible cause is a hardware failure of the extension cable, or module (I/O module or intelligent function module) connected. Please consult your local Mitsubishi representative.</li> </ul>		



<b>A01</b>	<b>System bus error</b>	24D0
<b>Details</b>		
<ul style="list-style-type: none"> <li>♦The extension level setting of the Q series extension base unit is overlapping with that of any other extension base units.</li> <li>♦An error was detected on the system bus.</li> </ul>		
<b>Remedy</b>		
<ul style="list-style-type: none"> <li>♦Check and correct the level setting of the Q series extension base unit.</li> <li>♦Check the connection status of the extension cable.</li> <li>♦Take measures to reduce noise.</li> <li>♦Reset the CPU module, and run it again. If the same error code is displayed again, the possible cause is a hardware failure of the CPU module, base unit, or extension cable. Please consult your local Mitsubishi representative.</li> </ul>		
<b>A01</b>	<b>System bus error</b>	24E0
<b>Details</b>		
<ul style="list-style-type: none"> <li>♦An error was detected on the system bus.</li> </ul>		
<b>Remedy</b>		
<ul style="list-style-type: none"> <li>♦Take measures to reduce noise.</li> <li>♦Reset the CPU module, and run it again. If the same error code is displayed again, the possible cause is a hardware failure of the CPU module or base unit. Please consult your local Mitsubishi representative.</li> </ul>		
<b>A01</b>	<b>WDT error</b>	2500
<b>Details</b>		
<ul style="list-style-type: none"> <li>♦The scan time exceeded the execution monitoring time set in parameter.</li> <li>♦The initial (1st) scan time exceeded the execution monitoring time set in the CPU parameters.</li> <li>♦The execution time of the fixed scan interrupt program exceeded the interrupt execution interval.</li> </ul>		
<b>Remedy</b>		
<ul style="list-style-type: none"> <li>♦Check the detailed information (time information) of the error by executing module diagnostics using the engineering tool, check the time setting, and take either of the following actions. <ul style="list-style-type: none"> <li>(1) Check and correct the program so that it can be executed within the execution monitoring time set in parameter.</li> <li>(2) Change the execution monitoring time setting to an appropriate value.</li> </ul> </li> <li>♦Check and correct the fixed scan interrupt program so that the processing completes within the interrupt execution interval. If the same error code is displayed again, the possible cause is a hardware failure of the CPU module. Please consult your local Mitsubishi representative.</li> </ul>		
<b>A01</b>	<b>WDT error</b>	2501
<b>Details</b>		
<ul style="list-style-type: none"> <li>♦The scan time exceeded the execution monitoring time set in parameter.</li> <li>♦The 2nd or later scan time exceeded the execution monitoring time set in the CPU parameters.</li> <li>♦The execution time of the fixed scan interrupt program exceeded the interrupt execution interval.</li> </ul>		
<b>Remedy</b>		
<ul style="list-style-type: none"> <li>♦Check the detailed information (time information) of the error by executing module diagnostics using the engineering tool, check the time setting, and take either of the following actions. <ul style="list-style-type: none"> <li>(1) Check and correct the program so that it can be executed within the execution monitoring time set in parameter.</li> <li>(2) Change the execution monitoring time setting to an appropriate value.</li> </ul> </li> <li>♦Check and correct the fixed scan interrupt program so that the processing completes within the interrupt execution interval. If the same error code is displayed again, the possible cause is a hardware failure of the CPU module. Please consult your local Mitsubishi representative.</li> </ul>		

<b>A01</b>	<b>Invalid interrupt</b>	2520
<b>Details</b>		
<ul style="list-style-type: none"> <li>♦Even though an interrupt was requested, there is no interrupt factor.</li> </ul>		
<b>Remedy</b>		
<ul style="list-style-type: none"> <li>♦Take measures to reduce noise.</li> <li>♦Reset the CPU module, and run it again. If the same error code is displayed again, the possible cause is a hardware failure of the CPU module, base unit, or module (I/O module or intelligent function module) connected. Please consult your local Mitsubishi representative.</li> </ul>		
<b>A01</b>	<b>Invalid interrupt</b>	2521
<b>Details</b>		
<ul style="list-style-type: none"> <li>♦Even though an interrupt was requested, there is no interrupt factor.</li> </ul>		
<b>Remedy</b>		
<ul style="list-style-type: none"> <li>♦Take measures to reduce noise.</li> <li>♦Reset the CPU module, and run it again. If the same error code is displayed again, the possible cause is a hardware failure of the CPU module, base unit, or module (I/O module or intelligent function module) connected. Please consult your local Mitsubishi representative.</li> </ul>		
<b>A01</b>	<b>Invalid interrupt</b>	2522
<b>Details</b>		
<ul style="list-style-type: none"> <li>♦An interrupt was requested from the module with no interrupt pointer setting.</li> </ul>		
<b>Remedy</b>		
<ul style="list-style-type: none"> <li>♦Check and correct the interrupt pointer setting in the module parameters.</li> <li>♦Take measures so that no interrupt is requested from the module with no interrupt pointer setting.</li> <li>♦Check and correct the interrupt setting in the buffer memory of the intelligent function module.</li> <li>♦Correct the BASIC program executed in the QD51.</li> </ul>		
<b>A01</b>	<b>Inter-module synch signal error</b>	2610
<b>Details</b>		
<ul style="list-style-type: none"> <li>♦An execution interval error of the synchronization interrupt program has been detected.</li> <li>♦An inter-module synchronization error has been detected.</li> </ul>		
<b>Remedy</b>		
<ul style="list-style-type: none"> <li>♦Take measures to reduce noise.</li> <li>♦Reset the CPU module, and run it again. If the same error code is displayed again, the possible cause is a hardware failure of the CPU module, base unit, extension cable, or module (I/O module or intelligent function module) connected. Please consult your local Mitsubishi representative.</li> </ul>		
<b>A01</b>	<b>Inter-module synch signal error</b>	2611
<b>Details</b>		
<ul style="list-style-type: none"> <li>♦An inter-module synchronization error has been detected.</li> </ul>		
<b>Remedy</b>		
<ul style="list-style-type: none"> <li>♦Take measures to reduce noise.</li> <li>♦Reset the CPU module, and run it again. If the same error code is displayed again, the possible cause is a hardware failure of the CPU module, base unit, extension cable, or module (I/O module or intelligent function module) connected. Please consult your local Mitsubishi representative.</li> </ul>		
<b>A01</b>	<b>Multiple CPU synch signal error</b>	2630
<b>Details</b>		
<ul style="list-style-type: none"> <li>♦An execution interval error of the synchronization interrupt program has been detected.</li> <li>♦A multiple CPU synchronization error has been detected.</li> </ul>		
<b>Remedy</b>		
<ul style="list-style-type: none"> <li>♦Take measures to reduce noise.</li> <li>♦Reset the CPU module, and run it again. If the same error code is displayed again, the possible cause is a hardware failure of the CPU module or base unit. Please consult your local Mitsubishi representative.</li> </ul>		

<b>A01</b>	<b>Multiple CPU synch signal error</b>	2631
	<b>Details</b>	
	<ul style="list-style-type: none"> <li>•A multiple CPU synchronization error has been detected.</li> </ul>	
	<b>Remedy</b>	
	<ul style="list-style-type: none"> <li>•Take measures to reduce noise.</li> <li>•Reset the CPU module, and run it again. If the same error code is displayed again, the possible cause is a hardware failure of the CPU module or base unit. Please consult your local Mitsubishi representative.</li> </ul>	
<b>A01</b>	<b>Boot function execution error</b>	3001
	<b>Details</b>	
	<ul style="list-style-type: none"> <li>•When the boot function was executed, the file format processing failed.</li> </ul>	
	<b>Remedy</b>	
	<ul style="list-style-type: none"> <li>•Reset the CPU module, and execute the boot function again. If the same error code is displayed again, the possible cause is a hardware failure of the CPU module. Please consult your local Mitsubishi representative.</li> </ul>	
<b>A01</b>	<b>Boot function execution error</b>	3003
	<b>Details</b>	
	<ul style="list-style-type: none"> <li>•When the boot function was executed, the file passwords did not match.</li> </ul>	
	<b>Remedy</b>	
	<ul style="list-style-type: none"> <li>•Check and correct the file password settings of the transfer source and transfer destination files.</li> <li>•Delete the boot setting.</li> </ul>	
<b>A01</b>	<b>Boot function execution error</b>	3004
	<b>Details</b>	
	<ul style="list-style-type: none"> <li>•When the boot function was executed, the CPU built-in memory capacity was exceeded.</li> </ul>	
	<b>Remedy</b>	
	<ul style="list-style-type: none"> <li>•Check and correct the boot setting.</li> <li>•Delete unnecessary files in the CPU built-in memory.</li> <li>•Clear the CPU built-in memory by selecting "Clear" to "Operation Setting at CPU Built-in Memory Boot" in the memory card parameters, and execute the boot function.</li> </ul>	
<b>A01</b>	<b>Boot function execution error</b>	3005
	<b>Details</b>	
	<ul style="list-style-type: none"> <li>•When the boot function is executed, the security key registered in the CPU module (or extended SRAM cassette) does not match the one that locks the boot source program.</li> <li>•When the boot function is executed, the security key is not registered in the CPU module (or extended SRAM cassette) even though the boot source program is locked with the security key.</li> </ul>	
	<b>Remedy</b>	
	<ul style="list-style-type: none"> <li>•Check and correct the security key setting.</li> <li>•Delete the boot setting.</li> </ul>	
<b>A01</b>	<b>Pointer setting error</b>	3300
	<b>Details</b>	
	<ul style="list-style-type: none"> <li>•The total number of points of local and global pointers used in the program exceeded the points set in the CPU parameters (pointer device area).</li> </ul>	
	<b>Remedy</b>	
	<ul style="list-style-type: none"> <li>•Check the detailed information (error location information) of the error by executing module diagnostics using the engineering tool, display the error program (step) by clicking the [Error Jump] button, and correct the program.</li> <li>•Check and correct the pointer device area point setting in the CPU parameters.</li> </ul>	

<b>A01</b>	<b>Pointer setting error</b>	3301
<b>Details</b>		
<ul style="list-style-type: none"> <li>♦The total number of points of pointertype labels used in the program exceeded the points set in the CPU parameters (label assignment area).</li> </ul>		
<b>Remedy</b>		
<ul style="list-style-type: none"> <li>♦Check the detailed information (error location information) of the error by executing module diagnostics using the engineering tool, display the error program (step) by clicking the [Error Jump] button, and correct the program.</li> <li>♦Check and correct the pointer-type label assignment area point setting in the CPU parameters.</li> </ul>		
<b>A01</b>	<b>Pointer setting error</b>	3302
<b>Details</b>		
<ul style="list-style-type: none"> <li>♦Multiple global pointers with the same number are used in the program. (The pointer numbers are overlapping.)</li> </ul>		
<b>Remedy</b>		
<ul style="list-style-type: none"> <li>♦Check the detailed information (error location information) of the error by executing module diagnostics using the engineering tool, display the error program (step) by clicking the [Error Jump] button, and correct the program.</li> </ul>		
<b>A01</b>	<b>Pointer setting error</b>	3303
<b>Details</b>		
<ul style="list-style-type: none"> <li>♦Multiple local pointers with the same number are used in the program. (The pointer numbers are overlapping.)</li> </ul>		
<b>Remedy</b>		
<ul style="list-style-type: none"> <li>♦Check the detailed information (error location information) of the error by executing module diagnostics using the engineering tool, display the error program (step) by clicking the [Error Jump] button, and correct the program.</li> </ul>		
<b>A01</b>	<b>Interrupt pointer setting error</b>	3320
<b>Details</b>		
<ul style="list-style-type: none"> <li>♦The interrupt pointer numbers used in the files are overlapping.</li> </ul>		
<b>Remedy</b>		
<ul style="list-style-type: none"> <li>♦Check the detailed information (error location information) of the error by executing module diagnostics using the engineering tool, display the error program (step) by clicking the [Error Jump] button, and correct the program.</li> </ul>		
<b>A01</b>	<b>Hardware failure</b>	3C00
<b>Details</b>		
<ul style="list-style-type: none"> <li>♦A hardware failure has been detected.</li> </ul>		
<b>Remedy</b>		
<ul style="list-style-type: none"> <li>♦Take measures to reduce noise.</li> <li>♦If the same error code is displayed again, the possible cause is a hardware failure of the CPU module. Contact the service center.</li> </ul>		
<b>A01</b>	<b>Hardware failure</b>	3C01
<b>Details</b>		
<ul style="list-style-type: none"> <li>♦A hardware failure has been detected.</li> </ul>		
<b>Remedy</b>		
<ul style="list-style-type: none"> <li>♦Take measures to reduce noise.</li> <li>♦Reset the CPU module, and run it again. If the same error code is displayed again, the possible cause is a hardware failure of the CPU module. Please consult your local Mitsubishi representative.</li> </ul>		

<b>A01</b>	<b>Hardware failure</b>	<b>3C02</b>
<b>Details</b>		
♦A hardware failure has been detected.		
<b>Remedy</b>		
♦Take measures to reduce noise.		
♦Reset the CPU module, and run it again. If the same error code is displayed again, the possible cause is a hardware failure of the CPU module. Please consult your local Mitsubishi representative.		
<b>A01</b>	<b>Hardware failure</b>	<b>3C03</b>
<b>Details</b>		
♦A hardware failure has been detected.		
<b>Remedy</b>		
♦Take measures to reduce noise.		
♦Reset the CPU module, and run it again. If the same error code is displayed again, the possible cause is a hardware failure of the CPU module. Please consult your local Mitsubishi representative.		
<b>A01</b>	<b>Hardware failure</b>	<b>3C0F</b>
<b>Details</b>		
♦A hardware failure has been detected.		
<b>Remedy</b>		
♦Take measures to reduce noise.		
♦Reset the CPU module, and run it again. If the same error code is displayed again, the possible cause is a hardware failure of the CPU module or extended SRAM cassette. Please consult your local Mitsubishi representative.		
<b>A01</b>	<b>Hardware failure</b>	<b>3C10</b>
<b>Details</b>		
♦A hardware failure has been detected.		
<b>Remedy</b>		
♦Take measures to reduce noise.		
♦Reset the CPU module, and run it again. If the same error code is displayed again, the possible cause is a hardware failure of the CPU module. Please consult your local Mitsubishi representative.		
<b>A01</b>	<b>Hardware failure</b>	<b>3C12</b>
<b>Details</b>		
♦The waveform of the voltage out of the specified range has been detected in the power supply module.		
♦A hardware failure has been detected in the power supply module, CPU module, base unit, or extension cable.		
<b>Remedy</b>		
♦Check the waveform of the voltage applied to the power supply module.		
♦Reset the CPU module, and run it again. If the same error code is displayed again, the possible cause is a hardware failure of the power supply module, CPU module, base unit, or extension cable. Please consult your local Mitsubishi representative.		
<b>A01</b>	<b>Hardware failure</b>	<b>3C13</b>
<b>Details</b>		
♦A hardware failure has been detected.		
<b>Remedy</b>		
♦Take measures to reduce noise.		
♦Reset the CPU module, and run it again. If the same error code is displayed again, the possible cause is a hardware failure of the CPU module. Please consult your local Mitsubishi representative.		

<b>A01</b>	<b>Hardware failure</b>	<b>3C14</b>
<b>Details</b>		
♦A hardware failure has been detected.		
<b>Remedy</b>		
♦Take measures to reduce noise.		
♦Reset the CPU module, and run it again. If the same error code is displayed again, the possible cause is a hardware failure of the CPU module. Please consult your local Mitsubishi representative.		
<b>A01</b>	<b>Hardware failure</b>	<b>3C17</b>
<b>Details</b>		
♦An error was detected relating to the execution order of the internal processes.		
<b>Remedy</b>		
♦Take measures to reduce noise.		
♦If the same error code is displayed again, the possible cause is a hardware failure of the CPU module. Contact the service center.		
<b>A01</b>	<b>Memory error</b>	<b>3C20</b>
<b>Details</b>		
♦An error has been detected in the memory.		
<b>Remedy</b>		
♦Take measures to reduce noise.		
♦Reset the CPU module, and run it again. If the same error code is displayed again, the possible cause is a hardware failure of the CPU module. Please consult your local Mitsubishi representative.		
<b>A01</b>	<b>Memory error</b>	<b>3C21</b>
<b>Details</b>		
♦An error has been detected in the memory.		
<b>Remedy</b>		
♦Take measures to reduce noise.		
♦Reset the CPU module, and run it again. If the same error code is displayed again, the possible cause is a hardware failure of the CPU module. Please consult your local Mitsubishi representative.		
<b>A01</b>	<b>Memory error</b>	<b>3C22</b>
<b>Details</b>		
♦An error has been detected in the memory.		
<b>Remedy</b>		
♦Take measures to reduce noise.		
♦Reset the CPU module, and run it again. If the same error code is displayed again, the possible cause is a hardware failure of the CPU module. Please consult your local Mitsubishi representative.		
<b>A01</b>	<b>Memory error</b>	<b>3C2F</b>
<b>Details</b>		
♦An error has been detected in the memory.		
<b>Remedy</b>		
♦Take measures to reduce noise.		
♦Reset the CPU module, and run it again. If the same error code is displayed again, the possible cause is a hardware failure of the CPU module. Please consult your local Mitsubishi representative.		
<b>A01</b>	<b>Memory error</b>	<b>3C31</b>
<b>Details</b>		
♦An error has been detected in the memory.		
<b>Remedy</b>		
♦Take measures to reduce noise.		
♦Format the memory. Write all files to the CPU module. Then, reset the CPU module, and run it again. If the same error code is displayed again, the possible cause is a hardware failure of the CPU module. Please consult your local Mitsubishi representative.		

<b>A01</b>	<b>Memory error</b>	<b>3C32</b>
	<b>Details</b>	
	♦An error has been detected in the memory.	
	<b>Remedy</b>	
	♦Take measures to reduce noise.	
	♦Reset the CPU module, and run it again. If the same error code is displayed again, the possible cause is a hardware failure of the CPU module. Please consult your local Mitsubishi representative.	
<b>A01</b>	<b>Operation circuit error</b>	<b>3E00</b>
	<b>Details</b>	
	♦An error has been detected in the CPU module.	
	<b>Remedy</b>	
	♦Take measures to reduce noise.	
	♦Format the memory. Write all files to the CPU module. Then, reset the CPU module, and run it again. If the same error code is displayed again, the possible cause is a hardware failure of the CPU module. Please consult your local Mitsubishi representative.	
<b>A01</b>	<b>Safety mutual monitoring error</b>	<b>3E60</b>
	<b>Details</b>	
	♦A crosscheck error was detected in the NC.	
	<b>Remedy</b>	
	♦Take measures to reduce noise.	
	♦If the same error code is displayed again, the possible cause is a hardware failure of the CPU module or the NC module. Contact the service center.	
<b>A01</b>	<b>Safety mutual monitoring error</b>	<b>3E61</b>
	<b>Details</b>	
	♦A crosscheck timeout was detected in the NC.	
	<b>Remedy</b>	
	♦Take measures to reduce noise.	
	♦If the same error code is displayed again, the possible cause is a hardware failure of the CPU module or the NC module. Contact the service center.	

# Parameter





## User Parameters

The parameters with "(PR)" requires the CNC to be turned OFF after the settings. Turn the power OFF and ON to enable the parameter settings.

### 15.1 Machining Parameters

#1026	base_I	Base axis I
	Set the names of the basic axes that compose the plane. Set the axis name set in "#1013 axname". If all three items ("base_I", "base_J" and "base_K") do not need to be set, such as for 2-axis specifications, input "0", and the parameter will be blank. Normally, when X, Y and Z are specified respectively for base_I, _J, _K, the following relation will be established: G17: X-Y G18: Z-X G19: Y-Z Or specify any other axis name desired.	
	<b>---Setting range---</b> Axis names such as X, Y or Z	
#1027	base_J	Base axis J
	Set the names of the basic axes that compose the plane. Set the axis name set in "#1013 axname". If all three items ("base_I", "base_J" and "base_K") do not need to be set, such as for 2-axis specifications, input "0", and the parameter will be blank. Normally, when X, Y and Z are specified respectively for base_I, _J, _K, the following relation will be established: G17: X-Y G18: Z-X G19: Y-Z Or specify any other axis name desired.	
	<b>---Setting range---</b> Axis names such as X, Y or Z	
#1028	base_K	Base axis K
	Set the names of the basic axes that compose the plane. Set the axis name set in "#1013 axname". If all three items ("base_I", "base_J" and "base_K") do not need to be set, such as for 2-axis specifications, input "0", and the parameter will be blank. Normally, when X, Y and Z are specified respectively for base_I, _J, _K, the following relation will be established: G17: X-Y G18: Z-X G19: Y-Z Or specify any other axis name desired.	
	<b>---Setting range---</b> Axis names such as X, Y or Z	
#1029	aux_I	Flat axis I
	Set the axis name when there is an axis parallel to "#1026 base_I".	
	<b>---Setting range---</b> Axis names such as X, Y or Z	

<b>#1030</b>	<b>aux_J</b>	<b>Flat axis J</b>
Set the axis name when there is an axis parallel to "#1027 base_J".		
<b>---Setting range---</b>		
Axis names such as X, Y or Z		
<b>#1031</b>	<b>aux_K</b>	<b>Flat axis K</b>
Set the axis name when there is an axis parallel to "#1028 base_K".		
<b>---Setting range---</b>		
Axis names such as X, Y or Z		
<b>#1084</b>	<b>RadErr</b>	<b>Arc error</b>
Set the tolerable error range when the end point deviates from the center coordinate in the circular command.		
<b>---Setting range---</b>		
0 to 1.000 (mm)		
<b>#1171</b>	<b>taprov</b>	<b>Tap return override</b>
Set the tap return override value for the synchronous tapping.		
When "0" is set, it will be regarded as 100%.		
<b>---Setting range---</b>		
0 to 100 (%)		
<b>#1185</b>	<b>spd_F1</b>	<b>F1 digit feedrate F1</b>
Set the feedrate for the F command in the F 1-digit command ("#1079 F1digit" is set to "1").		
Feedrate when F1 is issued (mm/min).		
When "#1246 set08/bit6" is set to "1" and F 1-digit feed is commanded, the feedrate can be increased/decreased by operating the manual handle.		
<b>---Setting range---</b>		
0 to 1000000 (mm/min)		
<b>#1186</b>	<b>spd_F2</b>	<b>F1 digit feedrate F2</b>
Set the feedrate for the F command in the F 1-digit command ("#1079 F1digit" is set to "1").		
Feedrate when F2 is issued (mm/min).		
When "#1246 set08/bit6" is set to "1" and F 1-digit feed is commanded, the feedrate can be increased/decreased by operating the manual handle.		
<b>---Setting range---</b>		
0 to 1000000 (mm/min)		
<b>#1187</b>	<b>spd_F3</b>	<b>F1 digit feedrate F3</b>
Set the feedrate for the F command in the F 1-digit command ("#1079 F1digit" is set to "1").		
Feedrate when F3 is issued (mm/min).		
When "#1246 set08/bit6" is set to "1" and F 1-digit feed is commanded, the feedrate can be increased/decreased by operating the manual handle.		
<b>---Setting range---</b>		
0 to 1000000 (mm/min)		
<b>#1188</b>	<b>spd_F4</b>	<b>F1 digit feedrate F4</b>
Set the feedrate for the F command in the F 1-digit command ("#1079 F1digit" is set to "1").		
Feedrate when F4 is issued (mm/min).		
When "#1246 set08/bit6" is set to "1" and F 1-digit feed is commanded, the feedrate can be increased/decreased by operating the manual handle.		
<b>---Setting range---</b>		
0 to 1000000 (mm/min)		

<b>#1189</b>	<b>spd_F5</b>	<b>F1 digit feedrate F5</b>
<p>Set the feedrate for the F command in the F 1-digit command ("#1079 F1digit" is set to "1").            Feedrate when F5 is issued (mm/min).            When "#1246 set08/bit6" is set to "1" and F 1-digit feed is commanded, the feedrate can be increased/decreased by operating the manual handle.</p> <p>---Setting range---            0 to 1000000 (mm/min)</p>		
<b>#1506</b>	<b>F1_FM</b>	<b>Upper limit of F 1-digit feedrate</b>
<p>Set the maximum value up to which the F 1-digit feedrate can be changed.</p> <p>---Setting range---            0 to 1000000 (mm/min)</p>		
<b>#1507</b>	<b>F1_K</b>	<b>F 1-digit feedrate change constant</b>
<p>Set the constant that determines the speed change rate per manual handle graduation in F 1-digit feedrate change mode.</p> <p>---Setting range---            0 to 32767</p>		
<b>#8001</b>	<b>WRK COUNT M</b>	
<p>Set the M code for counting the number of the workpiece repeated machining.            The number of the M-codes set by this parameter is counted.            The No. will not be counted when set to "0".</p> <p>---Setting range---            0 to 999</p>		
<b>#8002</b>	<b>WRK COUNT</b>	
<p>Set the initial value of the number of workpiece machining. The number of current workpiece machining is displayed.</p> <p>---Setting range---            0 to 999999</p>		
<b>#8003</b>	<b>WRK COUNT LIMIT</b>	
<p>Set the maximum number of workpiece machining.            A signal will be output to PLC when the number of machining times is counted to this limit.</p> <p>---Setting range---            0 to 999999</p>		
<b>#8004</b>	<b>SPEED</b>	
<p>Set the feedrate during automatic tool length measurement.</p> <p>---Setting range---            1 to 1000000 (mm/min)</p>		
<b>#8005</b>	<b>ZONE r</b>	
<p>Set the distance between the measurement point and deceleration start point.</p> <p>---Setting range---            0 to 99999.999 (mm)</p>		
<b>#8006</b>	<b>ZONE d</b>	
<p>Set the tolerable range of the measurement point.            An alarm will occur when the sensor signal turns ON before the range, set by this parameter, has not been reached from the measurement point, or when the signal does not turn ON after the range is passed.</p> <p>---Setting range---            0 to 99999.999 (mm)</p>		

<b>#8007</b>	<b>OVERRIDE</b>
Set the override value for automatic corner override.	
<b>---Setting range---</b>	
0 to 100 (%)	
<b>#8008</b>	<b>MAX ANGLE</b>
Set the maximum corner opening angle where deceleration should start automatically.	
When the angle is larger than this value, deceleration will not start.	
<b>---Setting range---</b>	
0 to 180 (°)	
<b>#8009</b>	<b>DSC. ZONE</b>
Set the position where deceleration starts at the corner.	
Designate at which length point before the corner deceleration should start.	
<b>---Setting range---</b>	
0 to 99999.999 (mm)	
<b>#8010</b>	<b>ABS. MAX.</b>
Set the maximum value when inputting the tool compensation amount.	
A value exceeding this setting value cannot be set.	
Absolute value of the input value is set.	
(If a negative value is input, it is treated and set as a positive value.)	
When "0" is set, this parameter is disabled.	
<b>---Setting range---</b>	
0 to 9999.999 (mm)	
(Input setting increment applies)	
<b>#8011</b>	<b>INC. MAX.</b>
Set the maximum value for when inputting the tool compensation amount in the incremental mode.	
A value exceeding this setting value cannot be set.	
Absolute value of the input value is set.	
(If a negative value is input, it is treated and set as a positive value.)	
When "0" is set, this parameter is disabled.	
<b>---Setting range---</b>	
0 to 9999.999 (mm)	
(Input setting increment applies)	
<b>#8038</b>	<b>Path recog. range</b>
Path recognition range	
Specify the range to recognize the tool paths adjoining to the command position when the smooth fairing function is ON.	
If "0" is set, the range will be 1.000 (mm).	
<b>---Setting range---</b>	
0 to 100.000 (mm)	
<b>#8039</b>	<b>Comp. range limit</b>
Compensation distance tolerance	
Specify the upper limit of the distance between the command position and compensation position when the smooth fairing function is ON.	
If you specify a negative value, operation is conducted with no tolerance limit.	
If "0" is set, the tolerance will be 0.005 (mm).	
<b>---Setting range---</b>	
-1.000 to 100.000 (mm)	

<b>#8041</b>	<b>C-rot.R</b>
	Set the length from the center of the normal line control axis to the tool tip. This is used to calculate the turning speed at the block joint. This is enabled during the normal line control type II.
	<b>---Setting range---</b> 0.000 to 99999.999 (mm)
<b>#8042</b>	<b>C-ins.R</b>
	Set the radius of the arc to be automatically inserted into the corner during normal line control. This is enabled during the normal line control type I.
	<b>---Setting range---</b> 0.000 to 99999.999 (mm)
<b>#8043</b>	<b>Tool HDL FD OFS</b>
	Set the length from the tool holder to the tool tip.
	<b>---Setting range---</b> 0.000 to 99999.999 (mm)
<b>#8044</b>	<b>UNIT*10</b>
	Set the command increment scale. The scale will be "1" when "0" is set.
	<b>---Setting range---</b> 0 to 10000 (fold) 0: One fold
<b>#8045</b>	<b>Varying spd thread</b>
	Select whether to enable the variable speed thread cutting function. 0: Disable 1: Enable
<b>#8061</b>	<b>G76 THICK</b>
	Set the minimum cutting amount for compound type thread cutting cycle (G76). The value set in this parameter will be applied when the cutting amount in compound thread cutting cycle (G76) without Q command is smaller than that in this parameter. This parameter is valid only when "#1222 aux06/bit4" is set to "1".
	<b>---Setting range---</b> 0.000 to 99999.999 (mm)
<b>#8069</b>	<b>G76G78in-posn wdt.</b>
	Specify the in-position check width to be used for deceleration check of G0-G0 blocks in thread cutting cycle (G76 or G78). When this parameter is set to "0", or when the option "Programmable in-position check" is OFF, normal deceleration check method is applied.
	<b>---Setting range---</b> 0.000 to 99.999 (mm) 0.0000 to 9.9999 (inch)
<b>#8070</b>	<b>Turning cycle mode</b>
	1: If a zero-travel distance block is given during turning cycle mode (G90, G92 or G94), the turning cycle is executed again. 0: If a zero-travel distance block is given during turning cycle mode (G90, G92 or G94), the turning cycle is not executed.
<b>#8071</b>	<b>3-D CMP (for M system only)</b>
	Not used. Set to "0.000".

<b>#8072</b>	<b>SCALING P (for M system only)</b>
	Set the scale factor for reduction or magnification in the machining program specified by G50 or G51 command.
	This parameter will be valid when the program specifies no scale factor.
	<b>---Setting range---</b>
	-99.999999 to 99.999999
<b>#8075</b>	<b>SpiralEndErr (for M system only)</b>
	Set the tolerable error range (absolute value) when the end point position, commanded by the spiral or conical interpolation command with the command format type 2, differs from the end point position obtained from the speed and increment/decrement amount.
	<b>---Setting range---</b>
	0 to 99999.999 (mm)
<b>#8077</b>	<b>Invlute error</b>
	Not used.
<b>#8078</b>	<b>Screen Saver Timer</b>
	Not used.
<b>#8081</b>	<b>Gcode Rotat (for L system only)</b>
	Set the rotation angle when the coordinate rotation by program is commanded.
	This parameter is enabled when "1" is set in "#1270 ext06/bit5" (Coordinate rotation angle without command).
	This parameter is set as absolute command regardless of the "#8082 G68.1 R INC" setting. If the rotation angle is designated by an address R in G68.1 command, the designation by program will be applied.
	<b>---Setting range---</b>
	-360.000 to +360.000 (°)
<b>#8082</b>	<b>G68.1 R INC (for L system only)</b>
	Select absolute command or incremental command to use for the rotation angle command R at L-system coordinate rotation.
	0: Use absolute command in G90 modal, incremental command in G91 modal
	1: Always use incremental command
	(Note) If G91 does not exist in the G code system, the command type is decided by this parameter only.
<b>#8621</b>	<b>Coord rot plane (H)</b>
	Not used. Set to "0".
<b>#8622</b>	<b>Coord rot plane (V)</b>
	Not used. Set to "0".
<b>#8623</b>	<b>Coord rot centr (H)</b>
	Not used. Set to "0.000".
<b>#8624</b>	<b>Coord rot centr (V)</b>
	Not used. Set to "0.000".
<b>#8625</b>	<b>Coord rot vctr (H)</b>
	Not used. Set to "0.000".
<b>#8626</b>	<b>Coord rot vctr (V)</b>
	Not used. Set to "0.000".
<b>#8627</b>	<b>Coord rot angle</b>
	Not used. Set to "0.000".
<b>#8701</b>	<b>Tool length</b>
	Set the length to the touch tool tip.
	<b>---Setting range---</b>
	-99999.999 to 99999.999 (mm)



<b>#8702</b>	<b>Tool Dia</b>
	Set the diameter of the sphere at the touch tool tip.
	<b>---Setting range---</b>
	-99999.999 to 99999.999 (mm)
<b>#8703</b>	<b>OFFSET X</b>
	This sets the deviation amount (X direction) from the touch tool center to the spindle center.
	<b>---Setting range---</b>
	-99999.999 to 99999.999 (mm)
<b>#8704</b>	<b>OFFSET Y</b>
	Set the deviation amount (Y direction) from the touch tool center to the spindle center.
	<b>---Setting range---</b>
	-99999.999 to 99999.999 (mm)
<b>#8705</b>	<b>RETURN</b>
	Set the one-time return distance for contacting again.
	<b>---Setting range---</b>
	0 to 99999.999 (mm)
<b>#8706</b>	<b>FEED</b>
	Set the feedrate when contacting again.
	<b>---Setting range---</b>
	1 to 60000 (mm/min)
<b>#8707</b>	<b>Skip past amount (H)</b>
	Set the difference (horizontal axis direction) between the skip read value and actual skip position.
	<b>---Setting range---</b>
	-99999.999 to 99999.999 (mm)
<b>#8708</b>	<b>Skip past amount (V)</b>
	Set the difference (vertical axis direction) between the skip read value and actual skip position.
	<b>---Setting range---</b>
	-99999.999 to 99999.999 (mm)
<b>#8709</b>	<b>EXT work sign rvs</b>
	Reverse the sign of external workpiece coordinate.
	Select when using the external workpiece coordinate system with Z shift.
	0: External workpiece offset without sign reversal
	1: External workpiece offset with sign reversal
<b>#8710</b>	<b>EXT work ofs invld</b>
	Set whether to enable external workpiece offset subtraction when setting the workpiece coordinate offset.
	0: Not subtract the external workpiece offset. (Conventional specification)
	1: Subtract the external workpiece offset.
<b>#8711</b>	<b>TLM L meas axis</b>
	Set the tool length measurement axis.
	Set the "#1022 axname2" axis name.
	<b>---Setting range---</b>
	Axis name
	(Note) If the axis name is illegal or not set, the 3rd axis name will be set as default.

<b>#8712</b>	<b>TLM D meas axis</b>
	<p>Set the tool diameter measurement axis. Set the "#1022 axname2" axis name.</p> <p><b>---Setting range---</b></p> <p>Axis name</p> <p>(Note) If the axis name is illegal or not set, the 1st axis name will be set as default.</p>
<b>#8713</b>	<b>Skip coord. Switch (For M system only)</b>
	<p>Select the coordinate system for reading skip coordinate value. Select whether to read the skip coordinate in the workpiece coordinate system or in the feature coordinate system during inclined surface machining command. Select whether to read the skip coordinate in the workpiece coordinate system or in the workpiece installation coordinate system during workpiece installation error compensation.</p> <p>0: Workpiece coordinate system 1: Feature coordinate system/Workpiece installation coordinate system</p>
<b>#8714</b>	<b>Thrdrecut lead ax</b>
	<p>Specify the name of lead axis that performs thread recutting. If any nonexistent axis name is specified, the 1st axis of the part system is used as a lead axis for thread recutting. If the parameter "#8714 Thrdrecut lead ax" is unspecified, Z axis is set as the parameter value at power ON.</p> <p><b>---Setting range---</b></p> <p>A,B,C,U,V,W,X,Y,Z</p>
<b>#8715</b>	<b>Thread recut SP#</b>
	<p>Specify the No. or name of spindle that performs thread recutting. If 0 or any nonexistent spindle No. or name is specified, the 1st spindle is used for thread recutting.</p> <p><b>---Setting range---</b></p> <p>Spindle No. method: 0 to 8 Spindle name method: 0 to 9 (Default: 0)</p>
<b>(PR) #8716</b>	<b>EXT/Wrksft Share (for L system only)</b>
	<p>Set this parameter to "1" if you wish to disable the external workpiece coordinate system offset. This parameter is enabled when "#11056 Workshift invalid (worksft invalid)" is "0".</p> <p>0: Use the external work coordinate offset (EXT) to implement compensation 1: Implement compensation without using the external work coordinate offset (EXT)</p>
<b>#12066</b>	<b>Tolerance ctrl ON</b>
	<p>Select whether to enable the tolerance control.</p> <p>0: Disable 1: Enable</p> <p>(Note) Tolerance control is available only under SSS control. To enable this function, set "#8090 SSS ON" to "1".</p>
<b>#12067</b>	<b>Tolerance spd coef</b>
	<p>Set the compensation coefficient to adjust a path error or clamp speed in the corner while tolerance control is ON.</p> <p>This parameter is enabled during tolerance control. Thus set this parameter if you wish to use different clamp speed according to ON/OFF of tolerance control.</p> <p>When "0" is set in this parameter, the standard value (100%) is applied.</p> <p><b>---Setting range---</b></p> <p>0 to 2000 (%)</p>

<b>#12068</b>	<b>Smoothing range</b>
Spline interpolation 2: Smoothing range Normally set "0" in this parameter. If you run a program with micro segments and its reciprocating paths are uneven, set the parameter to about 3 to 5 times the length of the programmed segments.	
---Setting range---	
0.000 to 10.000 (mm)	
<b>#12069</b>	<b>Corner angle</b>
Tolerance control: Corner recognition angle Specify the corner recognition angle. Normally set to "0".	
---Setting range---	
0.000 to 180.000 (°)	
<b>#19001</b>	<b>Syn.tap(,S)cancel</b>
0: Retain the spindle speed (,S) in synchronous tap return 1: Cancel the spindle speed (,S) in synchronous tap return with G80 The same value as "#1223 aux07/bit6" will be reflected. When either setting changes, the other will change accordingly.	
<b>#19002</b>	<b>Zero-point mark</b>
Not used.	
<b>#19003</b>	<b>PRG coord rot type</b>
Select the start point of the first travel command after coordinate rotation by program is commanded. 0: Calculate the end position using the current position on the local coordinate system before rotating, without rotating the start point in accordance with the coordinates rotation. 1: Calculate the end position, assuming that the start point rotates in accordance with the coordinates rotation.	
<b>#19004</b>	<b>Tap feedrate limit</b>
Set the upper limit of the cutting feed rate in synchronous tapping.	
---Setting range---	
0 to 1000 (mm/rev)	
(Note) Setting "0" disables this parameter. When the commanded cutting feed rate in synchronous tapping exceeds this setting, a program error (P184) will occur.	
<b>#19005</b>	<b>manual Fcmd2 clamp</b>
Set a clamp speed coefficient (%) for manual speed command 2. The feed rate is clamped at the command feed rate or rapid traverse rate for automatic operation, which was multiplied by this parameter's value. (Note) This setting is valid only for manual speed command 2.	
---Setting range---	
0 to 1000 (%)	
0: 100% (Default value)	
<b>(PR) #19006</b>	<b>EOR Disable</b>
Set whether to handle an EOR(%) in machining program as the end of program in automatic operation, graphic check, program transfer to NC memory, program editing, and buffer correction. Tape operation, Computer Link B, and serial input/output are not included. 0: An EOR(%) is handled as the end of machining program. 1: An EOR(%) is not handled as the end of machining program. The program will be read to the end of file.	
<b>#19007</b>	<b>Prg check constant</b>
Set the speed constant to be used for the program check operation function.	
---Setting range---	
0 to 60000	

<b>#19008</b>	<b>PRM coord rot type</b>
	Not used. Set to "0".
<b>#19009</b>	<b>Corner check angle</b>
	Not used. Set to "0".
<b>#19010</b>	<b>Corner check width</b>
	Not used. Set to "0.000".
<b>#19401</b>	<b>G33.n chamfer spd</b>
	Not used.
<b>#19405</b>	<b>Rotary ax drawing</b>
	Not used.
<b>#19406</b>	<b>Hob retract ON at alarm</b>
	Select whether to enable the retract at an alarm during hobbing. 0: Disable 1: Enable (Standard value: 0)
<b>#19407</b>	<b>Hob retract acceleration deceleration OFF</b>
	Select whether to disable the acceleration/deceleration of a retract. 0: Enable 1: Disable (Standard value: 0)
<b>#19417</b>	<b>Hole dec check 2</b>
	This is enabled when #1253 set25 bit2 is 1. The operation at the hole bottom and the hole drilling stop position is as below. 0: Perform no deceleration check. 1: Perform command deceleration check. 2: Perform in-position check. <Target fixed cycles> Machining center: G81, G82, G83, G73 Lathe: G83, G87, G83.2
<b>#19418</b>	<b>Arc inside min ovr (for M system only)</b>
	Not used.
<b>#19419</b>	<b>Timing sync system</b>
	Specify the counterpart part system for timing synchronization or for balance cut when the part system No. is omitted. Set the part system No. in a way that reflects the combination of two part systems as follows.  (Example) Timing synchronization between Part systems 1 and 3 Enter 3 for the 1st part system, and enter 1 for the 3rd part system.  (Note) When 0 is set, timing synchronization is carried out between Part systems 1 and 2. <b>---Setting range---</b> 0 to 8
<b>#19420</b>	<b>Arc inside ovr ON (for M system only)</b>
	Not used.
<b>#19421</b>	<b>Arc inside ovr typ (for M system only)</b>
	Not used.

<b>#19425</b>	<b>ManualB Std R1</b>
<p>Set a radius used as standard for the rotary axis speed.</p> <p>When the setting value of #19425 is larger than that of "#19427 ManualB Std R2", #19425 setting will be used as surface speed control standard radius 2: #19427 setting will be used as surface speed control standard radius 1.</p> <p><b>---Setting range---</b></p> <p>0 to 99999.999 (mm)</p>	
<b>#19426</b>	<b>ManualB Std F1</b>
<p>This sets the rotary axis speed for surface speed control standard radius 1 (ManualB Std R1).</p> <p>When the setting value of #19426 is larger than that of "#19428 ManualB Std F2", #19426 setting will be used as surface speed control standard speed 2: #19427 setting will be used as surface speed control standard speed 1.</p> <p><b>---Setting range---</b></p> <p>1 to 1000000 (°/min)</p>	
<b>#19427</b>	<b>ManualB Std R2</b>
<p>Set a radius used as standard for the rotary axis speed.</p> <p>When the same value is set as "#19425 ManualB Std R1", the surface speed control standard speed 1 (ManualB Std F1) will be selected as the rotary axis speed if the radius is less than that value. The surface speed control standard speed 2 (ManualB Std F2) is selected if larger than the set value.</p> <p><b>---Setting range---</b></p> <p>0 to 99999.999 (mm)</p>	
<b>#19428</b>	<b>ManualB Std F2</b>
<p>Set the rotary axis speed for surface speed control standard radius 2 (ManualB Std R2).</p> <p><b>---Setting range---</b></p> <p>1 to 1000000 (°/min)</p>	

## 15.2 Fixed Cycle Parameters

<b>#8012</b>	<b>G73n (for M system only)</b>
	Set the return amount for G73 (step cycle).
	<b>---Setting range---</b>
	0 to 99999.999 (mm)
<b>#8013</b>	<b>G83 n</b>
	Set the return amount for G83 (deep hole drilling cycle).
	<b>---Setting range---</b>
	0 to 99999.999 (mm)
<b>#8014</b>	<b>CDZ-VALE (for L system only)</b>
	Set the chamfering amount for G76, G78 (thread cutting cycle).
	<b>---Setting range---</b>
	0 to 127 (0.1 lead)
<b>#8015</b>	<b>CDZ-ANGLE (for L system only)</b>
	Set the chamfering angle for G76, G78 (thread cutting cycle).
	<b>---Setting range---</b>
	0 to 89 (°)
<b>#8016</b>	<b>G71 MINIMUM (for L system only)</b>
	Set the minimum value of the last cutting amount by the rough cutting cycle (G71, G72).
	The cutting amount of the last cutting will be the remainder. When the remainder is smaller than this parameter setting, the last cycle will not be executed.
	<b>---Setting range---</b>
	0 to 999.999 (mm)
<b>#8017</b>	<b>G71 DELTA-D (for L system only)</b>
	Set the change amount of the rough cutting cycle.
	The rough cutting cycle (G71, G72) cutting amount repeats $x+dx$ , $x$ , $x-dx$ using the value ( $x$ ) commanded with $D$ as a reference. Set the change amount $dx$ .
	<b>---Setting range---</b>
	0 to 999.999 (mm)
<b>#8018</b>	<b>G84/G74 n</b>
	Set the retract amount $m$ in a G84/G74/G88 pecking tapping cycle.
	(Note) In the case of a normal tapping cycle, set to "0".
	<b>---Setting range---</b>
	0 to 999.999 (mm)
<b>#8051</b>	<b>G71 THICK</b>
	Set the amount of cut-in by the rough cutting cycle (G71, G72)
	<b>---Setting range---</b>
	0 to 99999.999 (mm)
<b>#8052</b>	<b>G71 PULL UP</b>
	Set the amount of pull-up when returning to the cutting start point for the rough cutting cycle (G71, G72).
	<b>---Setting range---</b>
	0 to 99999.999 (mm)
<b>#8053</b>	<b>G73 U</b>
	Set the X-axis cutting margin of the forming rough cutting cycle (G73).
	<b>---Setting range---</b>
	-99999.999 to 99999.999 (mm)

<b>#8054</b>	<b>G73 W</b>
	Set the Z-axis cutting margin of the forming rough cutting cycle (G73).
	<b>---Setting range---</b>
	-99999.999 to 99999.999 (mm)
<b>#8055</b>	<b>G73 R</b>
	Set how many times cutting will be performed in the forming rough cutting cycle (G73).
	<b>---Setting range---</b>
	0 to 99999 (times)
<b>#8056</b>	<b>G74 RETRACT</b>
	Set the amount of retract in the cut-off cycle (G74, G75).
	<b>---Setting range---</b>
	0 to 999.999 (mm)
<b>#8057</b>	<b>G76 LAST-D</b>
	Set the amount of final cut-in by the compound type thread cutting (G76).
	<b>---Setting range---</b>
	0 to 999.999 (mm)
<b>#8058</b>	<b>G76 TIMES</b>
	Set how many times the amount of final cut-in cycle (G76 finish margin) will be divided in the compound type thread cutting (G76).
	<b>---Setting range---</b>
	0 to 99 (times)
<b>#8059</b>	<b>G76 ANGLE</b>
	Set the angle (thread angle) of the tool nose in the compound type thread cutting (G76).
	<b>---Setting range---</b>
	0 to 99 (°)
<b>#8083</b>	<b>G83S modeM (for M system only)</b>
	Not used.
<b>#8084</b>	<b>G83S Clearance (for M system only)</b>
	Not used. Set to "0.000".
<b>#8085</b>	<b>G83S Forward F (for M system only)</b>
	Not used. Set to "0".
<b>#8086</b>	<b>G83S Back F (for M system only)</b>
	Not used. Set to "0".

## 15.3 Control Parameters 1

(PR)	#1041	I_inch	Initial state (inch)
		Select the unit system for the program travel amount when the power is turned ON or reset and for position display. 0: Metric system 1: Inch system	
		(Note) The units of the following data are converted by "#1041 I_inch". - Command unit at power ON and reset (Inch/metric command mode) But under the following conditions, the unit will follow G20/G21 command modal even at reset. When reset modal is retained ("#1151 rstint"="0") When G code group 06 reset modal is retained ("#1210 RstGmd/bit5" ON) - Unit system for position display (counter, user parameter, tool, work offset) - User parameter I/O unit - Parameter unit of user parameters concerning length and speed - Arc error parameter (#1084 RadErr)	
	#1078	Decpt2	Decimal point type 2
		Select the increment of position commands that do not have a decimal point. 0: Minimum input command unit (follows "#1015 cunit") 1: 1mm (or 1inch) unit (For the dwell time, 1s unit is used.)	
	#1080	Dril_Z	Drilling Z fixed
		Select a fixed cycle hole drilling axis. 0: Use an axis vertical to the selected plane as hole drilling axis. 1: Use the Z axis as the hole drilling axis regardless of the selected plane.	
	#1091	Mpoint	Ignore middle point
		Select how to handle the middle point during G28 and G30 reference position return. 0: Pass the middle point designated in the program and move to the reference position. 1: Ignore the middle point designated in the program and move straight to the reference position.	
	#1103	T_Life	Validate life management
		Select whether to use the tool life management. 0: Not use tool life management. 1: Use tool life management.	
	#1104	T_Com2	Tool command method 2
		Select how to handle the tool command in the program when "#1103 T_Life" is set to "1". 0: Handle the command as group No. 1: Handle the command as tool No.  (Note) In the case of the tool life management III, the program tool command will be handled as the tool No. regardless of the setting.	
	#1105	T_sel2	Tool selection method 2
		Select the tool selection method when "#1103 T_Life" is set to "1". 0: Select in order of registered No. from the tools used in the same group. 1: Select the tool with the longest remaining life from the tools used or unused in the same group.	
	#1106	Tcount	Life management (for L system only)
		Select the input method when address N is omitted in inputting the data (G10 L3 command) for tool life management function II. 0: Time specified input 1: Number of times specified input	



<b>#1126</b>	<b>PB_G90</b>	<b>Playback G90</b>
Select the method to command the playback travel amount in the playback editing.		
0: Incremental value		
1: Absolute value		
<b>#1128</b>	<b>RstVCI</b>	<b>Clear variables by resetting</b>
Select how to handle the common variables when resetting.		
0: Common variables won't change after resetting.		
1: Common variables will be cleared #100 to #199 by resetting.		
<b>#1129</b>	<b>PwrVCI</b>	<b>Clear variables by power-ON</b>
Select how to handle the common variables when the power is turned ON.		
0: The common variables are in the same state as before turning the power OFF.		
1: Common variables will be cleared #100 to #199 when the power is turned ON.		
<b>#1302</b>	<b>AutoRP</b>	<b>Automatic return by program restart</b>
Select the method to move to the restart position when restarting the program.		
0: Move the system manually to the restart position and then restart the program.		
1: The system automatically moves to the restart position at the first activation after the program restarts.		
<b>#8101</b>	<b>MACRO SINGLE</b>	
Select how to control the blocks where the user macro command continues.		
0: Do not stop while macro blocks continue.		
1: Stop every block during signal block operation.		
<b>#8102</b>	<b>COLL. ALM OFF</b>	
Select the interference control to the workpiece from the tool diameter during tool radius compensation and nose R compensation.		
0: An alarm will be output and operation stops when an interference is judged.		
1: Changes the path to avoid interference.		
<b>#8103</b>	<b>COLL. CHK OFF</b>	
Select the interference control to the workpiece from the tool diameter during tool radius compensation and nose R compensation.		
0: Performs interference check.		
1: Does not perform interference check.		
<b>#8105</b>	<b>EDIT LOCK B</b>	
Select the edit lock for program Nos. 8000 to 9999 in the memory.		
0: Editing possible		
1: Prohibit the editing of above programs.		
When "1" is set, the file cannot be opened.		
<b>#8106</b>	<b>G46 NO REV-ERR (for L system only)</b>	
Select the control for the compensation direction reversal in G46 (nose R compensation).		
0: An alarm will be output and operation will stop when the compensation direction is reversed (G41 -> G42' G42 -> G41).		
1: An alarm won't occur when the compensation direction is reversed, and the current compensation direction will be maintained.		
<b>#8107</b>	<b>R COMPENSATION</b>	
Select whether to move to the inside because of a delay in servo response to a command during arc cutting mode.		
0: Move to the inside, making the arc smaller than the command value.		
1: Compensate the movement to the inside.		

<b>#8108</b>	<b>R COMP Select</b>
<p>Select the arc radius error compensation target.</p> <p>0: Perform compensation over all axes.</p> <p>1: Perform compensation axis by axis.</p> <p>(Note) This parameter is effective only when "#8107 R COMPENSATION" is "1".</p>	
<b>#8109</b>	<b>HOST LINK</b>
<p>Not used.</p>	
<b>#8110</b>	<b>G71/G72 POCKET</b>
<p>Select whether to enable the pocket machining when there is a dimple (pocket) in the rough cutting cycle (G71, G72) finishing program.</p> <p>0: OFF</p> <p>1: ON</p>	
<b>#8111</b>	<b>Milling Radius</b>
<p>Select the diameter and radius of the linear axis for milling (cylindrical/pole coordinate) interpolation.</p> <p>0: All axes radius command</p> <p>1: Each axis setting (follows "#1019 dia")</p> <p>(Note) This parameter is valid only in the milling (cylindrical/polar coordinate) interpolation mode.</p>	
<b>#8112</b>	<b>DECIMAL PNT-P</b>
<p>Select whether to enable the decimal point command for G04 address P.</p> <p>0: Disable</p> <p>1: Enable</p>	
<b>#8113</b>	<b>Milling Init G16</b>
<p>Set which plane to execute for milling machining after the power is turned ON or reset.</p> <p>#8113: 0, #8114: 0 ---&gt; G17 plane</p> <p>#8113: 0, #8114: 1 ---&gt; G19 plane</p> <p>#8113: 1, #8114: 0 ---&gt; G16 plane</p> <p>#8113: 1, #8114: 1 ---&gt; G16 plane</p> <p>0: Not G16 plane</p> <p>1: G16 plane</p> <p>(Note) This parameter is valid for the G code system 2, 3, 4 or 5 ("#1037 cmdtyp"="3", "4", "5" or "6").</p>	
<b>#8114</b>	<b>Milling Init G19</b>
<p>Set which plane to execute for milling machining after the power is turned ON or reset.</p> <p>#8113: 0, #8114: 0 ---&gt; G17 plane</p> <p>#8113: 0, #8114: 1 ---&gt; G19 plane</p> <p>#8113: 1, #8114: 0 ---&gt; G16 plane</p> <p>#8113: 1, #8114: 1 ---&gt; G16 plane</p> <p>0: Not G19 plane</p> <p>1: G19 plane</p> <p>(Note) This parameter is valid for the G code system 2, 3, 4 or 5 ("#1037 cmdtyp"="3", "4", "5" or "6").</p>	

<b>#8115</b>	<b>G83/87 RAPID</b>
	Select the operation upon the completion of each step in deep hole drilling cycle (G83, G87). 0: Returns to R point before performing next step. 1: Returns by the amount of d (parameter setting) setting value before performing next step.
<b>#8116</b>	<b>CoordRotPara invd</b>
	Not used. Set to "0".
<b>#8117</b>	<b>OFS Diam DESIGN</b>
	Select tool radius or tool diameter compensation amount to be specified. 0: Tool radius compensation amount 1: Tool diameter compensation amount
<b>#8119</b>	<b>Comp. unit switch</b>
	Select the setting unit of compensation amount that has no decimal point. 0: 1mm (or 1inch) unit 1: The minimum command unit (follows "#1003 iunit")
<b>#8120</b>	<b>FONT SELECTION</b>
	Not used.
<b>#8121</b>	<b>Screen Capture</b>
	Not used.
<b>#8122</b>	<b>Keep G43 MDL M-REF</b>
	Select whether to keep the tool length offset by high speed manual reference position return during tool length offset. 0: Will not be kept (Cancel) 1: Hold
<b>#8123</b>	<b>H-spd retract ON</b>
	Select whether to enable high-speed retract while fixed cycle for drilling is running. 0: Disable 1: Enable
<b>#8124</b>	<b>Mirr img at reset</b>
	Select the operation type of the mirror image by parameter setting and the mirror image by external input. 0: The current mirror image is canceled, and new mirror image will start with the machine position at reset as the mirror center. 1: The mirror center is kept to continue the mirror image.
<b>#8125</b>	<b>Check Scode in G84</b>
	Select how to operate when there is no S command in synchronous tapping block. 0: Use the spindle function modal value as S-command value. 1: Output a program error (P181).
<b>#8126</b>	<b>Disable op tone</b>
	Not used.
<b>#8127</b>	<b>R-Navi manu F coor</b>
	Not used.
<b>#8129</b>	<b>Subpro No. select</b>
	Select the subprogram No. to be called preferentially in subprogram control. 0: Commanded program No. 1: Four-digit program No. beginning with O No. 2: Eight-digit program No. beginning with O No. (Note) The program to be called in user macro, figure rotation, macro interruption and compound type fixed cycle also follows this setting.

<b>#8130</b>	<b>Dwell in rev.</b>
Select the type of dwell for G04.	
0: Dwell time is specified in seconds, irrespective of the synchronous feed mode (G95) or the asynchronous feed mode (G94). For G04D, the dwell specified in spindle revolutions is applied.	
1: Dwell time is specified in spindle revolutions while the synchronous feed mode (G95) is ON, whereas it is specified in seconds while the asynchronous feed mode (G94) is ON.	
<b>#8131</b>	<b>High speed/accu 3</b>
Select whether to treat high-speed high-accuracy control II command as high-speed high-accuracy control III command.	
0: Treat G05P10000 as high-speed high-accuracy control II command (G05P10000).	
1: Treat G05P10000 as high-speed high-accuracy control III command (G05P20000).	
<b>#8132</b>	<b>G53.6 block stop</b>
Select whether to execute a single block stop at the completion of rotation of each axis when G53.6 is given with the number of simultaneous contour control axes limited to 4.	
0: Not execute a single block stop	
1: Execute a single block stop	
<b>#8133</b>	<b>Intrctv macro call</b>
Not used.	
<b>#8134</b>	<b>Email send disable</b>
Not used.	
<b>#8135</b>	<b>G5P4 single block</b>
Not used. Set to "0".	
<b>#8145</b>	<b>Validate F1 digit</b>
Select whether to execute the F command with a 1-digit code command or with a direct numerical command. (The same value as "#1079 F1digit" will be reflected. When either setting changes, the other will change accordingly.)	
0: Direct numerical command (command feedrate during feed per minute or rotation)	
1: 1-digit code command (with the feedrate specified by the parameters "#1185 spd_F1" to "#1189 spd_F5")	
<b>#8155</b>	<b>Sub-pro interrupt</b>
Select the type of the user macro interrupt. (The same value as "#1229 set01/bit0" will be reflected. When either setting changes, the other will change accordingly.)	
0: The user macro interrupt of macro type	
1: The user macro interrupt of sub-program type	
<b>#8156</b>	<b>Fine thread cut E</b>
Select what is to be specified with the address E. (The same value as "#1229 set01/bit1" will be reflected. When either setting changes, the other will change accordingly.)	
0: Specify the number of threads per inch for inch screw cutting.	
1: Specify the precision lead for inch screw cutting.	

<b>#8157</b>	<b>Radius comp type B (M system) / Nose R comp type B (L system)</b>
<p>For M system</p> <p>Select the method of the arithmetic processing for the intersection point when the start-up or cancel command is operated during radius compensation. (The same value as "#1229 set01/bit2" will be reflected. When either setting changes, the other will change accordingly.)</p> <p>0: The processing does not handle the start-up or cancel command block: handle the offset vector in the direction vertical to that of the command instead.</p> <p>1: The processing is executed for the intersection point between the command block and the next block.</p> <p>For L system</p> <p>Select the method of the arithmetic processing for the intersection point when the start-up or cancel commands are operated during nose R or radius compensation. (The same value as "#1229 set01/bit2" will be reflected. When either setting changes, the other will change accordingly.)</p> <p>0: The processing does not handle the start-up or cancel command block: handle the offset vector in the direction vertical to that of the command instead.</p> <p>1: The processing is executed for the intersection point between the command block and the next block.</p>	
<b>#8158</b>	<b>Init const sur spd</b>
<p>Select the initial state after the power-ON. (The same value as "#1229 set01/bit3" will be reflected. When either setting changes, the other will change accordingly.)</p> <p>0: Constant surface speed control cancel mode</p> <p>1: Constant surface speed control mode.</p>	
<b>#8159</b>	<b>Synchronous tap</b>
<p>Select whether to use the floating tap chuck in G74 and G84 tap cycles. (The same value as "#1229 set01/bit4" will be reflected. When either setting changes, the other will change accordingly.)</p> <p>0: With a floating tapping chuck</p> <p>1: Without a floating tapping chuck</p>	
<b>#8160</b>	<b>Start point alarm</b>
<p>Select an operation when the operation start point cannot be found while moving to the next block of G117. (The same value as "#1229 set01/bit5" will be reflected. When either setting changes, the other will change accordingly.)</p> <p>0: The auxiliary function is enabled after the block for the movement has finished.</p> <p>1: The program error (P33) occurs.</p>	

## 15.4 Control Parameters 2

#1025	L_plane	Initial plane selection
	Select the plane to be selected when the power is turned ON or reset. When 0 is specified, 1 is assumed (X-Y plane).e model and specifications.	
	1: X-Y plane (G17 command state) 2: Z-X plane (G18 command state) 3: Y-Z plane (G19 command state)	
(PR) #1037	cmdtyp	Command type
	Set the G code list and compensation type for programs.	
	1: List1 (for M)    Type I (one compensation amount for one compensation No.) 2: List1 (for M)    Type II (shape and wear compensation amounts for one comp. No.) 3: List2 (for L)    Type III (shape and wear compensation amounts for one comp. No.) 4: List3 (for L)    Ditto 5: List4 (for special L)    Ditto 6: List5 (for special L)    Ditto 7: List6 (for special L)    Ditto 8: List7 (for special L)    Ditto 9: List8 (for M)    M2 form at type    Type I (one compensation amount for one compensation No.) 10: List8 (for M)    M2 form at type    Type II (shape and wear compensation amounts for one compensation No.)	
	There are some items in the specifications that can be used or cannot be used according to the value set in this parameter.	
	The file structure may also change depending on the compensation data type.	
	(Note) When this parameter is changed, the file system will be changed after the power is turned ON. So always execute format. The new format will be enabled after turning the power ON again.	
	Setting order (1) cmdtyp changeover -> (2) Turn power ON again -> (3) Format -> (4) Turn power ON again	
	(Note) Compensation type III can be selected for M system by setting #1046.	
#1073	L_Absm	Initial absolute setting
	Select the mode (absolute or incremental) at turning ON the power or reset.	
	0: Incremental setting 1: Absolute setting	
#1074	L_Sync	Initial synchronous feed
	Select the feedrate mode at turning ON the power or reset.	
	0: Asynchronous feed (feed per minute) 1: Synchronous feed (feed per revolution)	
#1075	L_G00	Initial G00
	Select the linear command mode at turning ON the power or reset.	
	0: Linear interpolation (G01 command state) 1: Positioning (G00 command state)	
#1076	Absinc	ABS/INC address (for L system only)
	Select the command method for the absolute and incremental commands. The absolute command/incremental command can be issued by using the absolute command address and incremental command address for the same axis.	
	0: Use G command for the absolute and incremental commands. 1: Use axis name for the absolute and incremental commands.	
	(The axis name in "#1013 axname" will be the absolute command, "#1014 incax" will be the incremental command.)	

<b>#1085</b>	<b>G00Drn</b>	<b>G00 dry run</b>
	Select whether to apply dry run (feed at manual setting speed instead of command feedrate) to the G00 command.	
	0: Not apply to G00. (move at rapid traverse rate)	
	1: Apply to G00. (move at manual setting speed)	
<b>#1086</b>	<b>G0Intp</b>	<b>G00 non-interpolation</b>
	Select the G00 travel path type.	
	0: Move linearly toward the end point. (interpolation type)	
	1: Move to the end point of each axis at the rapid traverse feedrate for each axis. (non-interpolation)	
	(Note) If this parameter is set to "1", neither of the following functions will be available: rapid traverse constant-gradient acceleration/deceleration and rapid traverse constant-gradient multi-step acceleration/deceleration.	
<b>#1148</b>	<b>I_G611</b>	<b>Initial hi-precis</b>
	Select the modal state at power ON from among the following: high-accuracy control mode, high-speed high-accuracy control I mode, high-speed high-accuracy control II mode or high-speed high-accuracy control III mode.	
	0: G08P0/G64 (cutting) mode	
	1: G08P1/G61.1 (high-accuracy control) mode	
	2: G05.1Q1 (high-speed high-accuracy control I) mode	
	3: G05P10000 (high-speed high-accuracy control II) mode	
	4: G05P20000 (high-speed high-accuracy control III) mode	
<b>#8173</b>	<b>Hold intr amount</b>	
	Select whether to clear or hold the interruption amount after the "NC reset 1 (or 2)" signal is ON when the manual ABS switch is OFF.	
	0: Clear (Reset the coordinate deviation due to the interruption)	
	1: Hold	
<b>#8174</b>	<b>T meas. in mirror</b>	
	Select the measurement operation for mirror-imaged axes during the manual tool length measurement 1 or 2.	
	0: Set the measurement result as the tool length.	
	1: Reverse the sign of measurement result and set it as the tool length.	

## 15.5 Axis Parameters

<b>#1063</b>	<b>mandog</b>	<b>Manual dog-type</b>
<p>Select the manual reference position return method for the second return (after the coordinate system is established) and later.</p> <p>The initial reference position return after the power ON is performed with dog-type return, and the coordinate system will be established.</p> <p>(This setting is not required when the absolute position detection is used.)</p> <p>0: High speed return 1: Dog-type</p>		
<b>#8201</b>	<b>AX. RELEASE</b>	
<p>Select the function to remove the control axis from the control target.</p> <p>0: Control as normal. 1: Remove from control target.</p>		
<b>#8202</b>	<b>OT-CHECK OFF</b>	
<p>Select whether to enable the stored stroke limit II function set in #8204 and #8205.</p> <p>0: Enable 1: Disable</p>		
<b>#8203</b>	<b>OT-CHECK-CANCEL</b>	
<p>When the simple absolute position method ("#2049 type" is "9") is selected, the stored stroke limits I, II (or IIB) and IB can be disabled until the first reference position return is executed after the power is turned ON.</p> <p>0: Enable (according to #8202) 1: Temporarily cancel</p> <p>(Note) "#8203 OT-CHECK-CANCEL" affects all the stored stroke limits.</p>		
<b>#8204</b>	<b>OT-CHECK-N</b>	
<p>Set the coordinates of the (-) direction in the movable range of the stored stroke limit II or the lower limit coordinates of the prohibited range of stored stroke limit IIB.</p> <p>If the sign and value are the same as #8205, the stored stroke limit II (or IIB) will be invalid.</p> <p>If the stored stroke limit IIB function is selected, the prohibited range will be between two points even when #8204 and #8205 are set in reverse. When II is selected, the entire range will be prohibited if #8204 and #8205 are set in reverse.</p> <p>---Setting range---</p> <p>-99999.999 to 99999.999 (mm)</p>		
<b>#8205</b>	<b>OT-CHECK-P</b>	
<p>Set the coordinates of the (+) direction in the movable range of the stored stroke limit II or the upper limit coordinates of the prohibited range of stored stroke limit IIB.</p> <p>---Setting range---</p> <p>-99999.999 to 99999.999 (mm)</p>		
<b>#8206</b>	<b>TOOL CHG. P</b>	
<p>Set the coordinates of the tool change position for G30. n (tool change position return).</p> <p>Set with coordinates in the basic machine coordinate system.</p> <p>---Setting range---</p> <p>-99999.999 to 99999.999 (mm)</p>		
<b>#8207</b>	<b>G76/87 IGNR (for M system only)</b>	
<p>Select whether to enable the shift operation at G76 (fine boring) and G87 (back boring).</p> <p>0: Shift effective 1: No shift</p>		



#8208	<b>G76/87 (-) (for M system only)</b>
	Select the shift direction at G76 and G87. 0: Shift to (+) direction 1: Shift to (-) direction
#8209	<b>G60 SHIFT (for M system only)</b>
	Set the last positioning direction and distance for a G60 (unidirectional positioning) command. <b>---Setting range---</b> -99999.999 to 99999.999 (mm)
#8210	<b>OT INSIDE</b>
	Select whether the stored stroke limit function set by #8204 and #8205 prevents the machine from moving to the inside or outside of the specified range. 0: Inhibits outside area (Select stored stroke limit II.) 1: Inhibits inside area (Select stored stroke limit IIB.)
#8211	<b>MIRR. IMAGE</b>
	Select whether to enable the parameter mirror image function. 0: Disable 1: Enable
(PR) #8213	<b>Rotation axis type</b>
	Select the rotation type (short-cut valid/invalid) or linear type (workpiece coordinate linear type/all coordinate linear type). This parameter is enabled only when "#1017 rot" is set to "1". (Note) 0: Short-cut invalid 1: Short-cut valid 2: Workpiece coordinate linear type 3: All coordinate linear type  (Note) The movement method is as follows by the specified rotation axis type.  <Workpiece coordinate value> 0, 1: Display range 0° to 359.999° 2, 3: Display range 0° to ±99999.999° <Machine coordinate value/relative position> 0, 1, 2: Display range 0° to 359.999° 3: Display range 0° to ±99999.999° <ABS command> 0: The incremental amount from the end point to the current position is divided by 360, and the axis moves by the remainder amount according to the sign. 1: Moves with a short-cut to the end point. 2, 3: In the same manner as the normal linear axis, moves according to the sign by the amount obtained by subtracting the current position from the end point. <INC command> 0, 1, 2, 3: Moves in the direction of the commanded sign by the commanded incremental amount starting at the current position. <Reference position return> 0, 1, 2: The movement to the middle point applies to the ABS command or the INC command. Returns with movement within 360 degrees from the middle point to reference position. 3: The movement to the middle point applies to the ABS command or the INC command. Moves and returns in the reference position direction for the difference from the current position to the reference position.

	<b>#8215</b>	<b>TLM std length</b>
		Set the TLM standard length. TLM standard length is the distance from a tool replacement point (reference position) to the measurement basic point (surface) which is used to measure the tool length. (The same value as "#2016 tlm+" will be reflected. When either setting changes, the other will change accordingly.) <b>---Setting range---</b> -99999.999 to 99999.999 (mm)
	<b>#8216</b>	<b>Type in G28 return</b>
		Select the performance after establishing the reference position in reference position return command. 0: Moves to the reference position. 1: Won't move to the reference position.
	<b>#8217</b>	<b>Check start point</b>
		Not used.
	<b>#8218</b>	<b>Dir cmd retrct amt</b>
		Not used. Set to "0.000".
	<b>#8219</b>	<b>Hob retract amount 1</b>
		Set the retract amount using the radius value when the Hob retract amount selection signal is OFF. (Radius value) Retract is carried out in the negative direction if a negative value is set. <b>---Setting range---</b> -99999.999 to 99999.999 (mm)
	<b>#8220</b>	<b>Hob retract amount 2</b>
		Set the retract amount using the radius value when the Hob retract amount selection signal is ON. (Radius value) Retract is carried out in the negative direction if a negative value is set. <b>---Setting range---</b> -99999.999 to 99999.999 (mm)
	<b>#8221</b>	<b>Hob retract speed</b>
		Set the retract speed during hobbing. <b>---Setting range---</b> 1 to 1000000 (mm/min)
<b>(PR)</b>	<b>#8224</b>	<b>Posn display range</b>
		Current position display range Select the display range of the current position. 0: 0 to 359.999 deg 1: -99999.999 to 99999.999 deg
<b>(PR)</b>	<b>#8225</b>	<b>Wk coord at R ret.</b>
		Workpiece coordinate position displayed right after automatic reference position return Select whether to apply a range of 0 to 360 degrees to the workpiece coordinate position displayed right after automatic reference position return if the said position is out of the range of 0 to 360 degrees. 0: Display the position in a range of 0 to 360 degrees 1: Not display the position in a range of 0 to 360 degrees
	<b>#8226</b>	<b>Wk position check</b>
		Workpiece position check Select whether to check a difference of workpiece coordinate position between when NC is reset and when program operation is started, when both High-speed simple program check mode ON (X712) and High-speed simple program check: Coordinate position check ON (X713) are set to ON. 0: Disable the check 1: Enable the check

---

**#8227      Machine posn check**

---

Machine position check

Select whether to check a difference of machine coordinate command position between when NC is reset and when program operation is started, when both High-speed simple program check mode ON (X712) and High-speed simple program check: Coordinate position check ON (X713) are set to ON.

0: Disable the check

1: Enable the check

## 15.6 Ethernet Parameters

(PR)	#1926	Global IP address	IP address
		Set the main CPU's IP address.	
		Set the NC IP address seen from an external source.	
		<b>---Setting range---</b>	
		Set these parameters in accordance with the network rules in the connection environment.	
(PR)	#1927	Global Subnet mask	Subnet mask
		Set the subnet mask for the IP address.	
		<b>---Setting range---</b>	
		Set these parameters in accordance with the network rules in the connection environment.	
(PR)	#1928	Global Gateway	Gateway
		Set the IP address for the gateway.	
		<b>---Setting range---</b>	
		Set these parameters in accordance with the network rules in the connection environment.	
(PR)	#1934	Local IP address	
		Not used.	
(PR)	#1935	Local Subnet mask	
		Not used.	
(PR)	#1937	NET1 IP Address	NET1 IP address
		Not used.	
(PR)	#1938	NET2 IP Address	NET2 IP address
		Not used.	
(PR)	#1939	NET3 IP Address	NET3 IP address
		Not used.	
(PR)	#1940	NET4 IP Address	NET4 IP address
		Not used.	
	#1941	Local time compen	Local time correction
		Not used.	
(PR)	#1953	Intra IP address	IP address on non-Windows-based display unit (LAN1) side
		Not used.	
(PR)	#1954	Intra Subnet mask	Subnet mask on non-Windows-based display unit (LAN1) side
		Not used.	
(PR)	#1955	Intra Gateway	Gateway on non-Windows-based display unit (LAN1) side
		Not used.	
(PR)	#9701	IP addr auto set	
		Not used.	
	#9706	Host No.	
		Select the No. of the host to be used from host 1 to host 4.	
		<b>---Setting range---</b>	
		1 to 4: Host No.	

<b>#9711</b>	<b>Host1 host name</b>
	Set the IP address of the FTP server. <Setting example> 150.40.0.111 ---Setting range--- 0.0.0.0 to 255.255.255.255
<b>#9712</b>	<b>Host1 user name</b>
	Set the user name when connecting to the FTP server. ---Setting range--- 15 characters (alphanumeric or symbol) or less
<b>#9713</b>	<b>Host1 password</b>
	Set the password when connecting to the FTP server. ---Setting range--- 15 characters (alphanumeric or symbol) or less
<b>#9714</b>	<b>Host1 directory</b>
	Set the full path of a file to download from the FTP server. * Use "/" (slash) as a separator of directory for Windows type server as well. ---Setting range--- 31 characters (alphanumeric) or less
<b>#9715</b>	<b>Host1 host type</b>
	Not used.
<b>#9716</b>	<b>Host 1 Wrd pos: name</b>
	Not used.
<b>#9717</b>	<b>Host 1 Wrd pos: size</b>
	Not used.
<b>#9718</b>	<b>Host 1 Wrd pos: Dir</b>
	Not used.
<b>#9719</b>	<b>Host 1 Wrd pos: cmnt</b>
	Not used.
<b>#9720</b>	<b>Host 1 Wrd num: cmnt</b>
	Not used.
<b>#9721</b>	<b>Host 1 no total siz</b>
	Not used.
<b>#9731</b>	<b>Host2 host name</b>
	Set the IP address of the FTP server. <Setting example> 150.40.0.111 ---Setting range--- 0.0.0.0 to 255.255.255.255
<b>#9732</b>	<b>Host2 user name</b>
	Set the user name when connecting to the FTP server. ---Setting range--- 15 characters (alphanumeric or symbol) or less
<b>#9733</b>	<b>Host2 password</b>
	Set the password when connecting to the FTP server. ---Setting range--- 15 characters (alphanumeric or symbol) or less

<b>#9734</b>	<b>Host2 directory</b>
	Set the full path of a file to download from the FTP server. * Use "/" (slash) as a separator of directory for Windows type server as well.
	<b>---Setting range---</b>
	31 characters (alphanumeric) or less
<b>#9735</b>	<b>Host2 host type</b>
	Not used.
<b>#9736</b>	<b>Host 2 Wrđ pos: name</b>
	Not used.
<b>#9737</b>	<b>Host 2 Wrđ pos: size</b>
	Not used.
<b>#9738</b>	<b>Host 2 Wrđ pos: Dir</b>
	Not used.
<b>#9739</b>	<b>Host 2 Wrđ pos: cmnt</b>
	Not used.
<b>#9740</b>	<b>Host 2 Wrđ num: cmnt</b>
	Not used.
<b>#9741</b>	<b>Host 2 no total siz</b>
	Not used.
<b>#9751</b>	<b>Host3 host name</b>
	Set the IP address of the FTP server. <Setting example> 150.40.0.111
	<b>---Setting range---</b>
	0.0.0.0 to 255.255.255.255
<b>#9752</b>	<b>Host3 user name</b>
	Set the user name when connecting to the FTP server.
	<b>---Setting range---</b>
	15 characters (alphanumeric or symbol) or less
<b>#9753</b>	<b>Host3 password</b>
	Set the password when connecting to the FTP server.
	<b>---Setting range---</b>
	15 characters (alphanumeric or symbol) or less
<b>#9754</b>	<b>Host3 directory</b>
	Set the full path of a file to download from the FTP server. * Use "/" (slash) as a separator of directory for Windows type server as well.
	<b>---Setting range---</b>
	31 characters (alphanumeric) or less
<b>#9755</b>	<b>Host3 host type</b>
	Not used.
<b>#9756</b>	<b>Host 3 Wrđ pos: name</b>
	Not used.
<b>#9757</b>	<b>Host 3 Wrđ pos: size</b>
	Not used.
<b>#9758</b>	<b>Host 3 Wrđ pos: Dir</b>
	Not used.
<b>#9759</b>	<b>Host 3 Wrđ pos: cmnt</b>
	Not used.

	<b>#9760</b>	<b>Host 3 Wrd num: cmnt</b>	
			Not used.
	<b>#9761</b>	<b>Host 3 no total siz</b>	
			Not used.
	<b>#9771</b>	<b>Host4 host name</b>	
			Set the IP address of the FTP server. <Setting example> 150.40.0.111 ---Setting range--- 0.0.0.0 to 255.255.255.255
	<b>#9772</b>	<b>Host4 user name</b>	
			Set the user name when connecting to the FTP server. ---Setting range--- 15 characters (alphanumeric or symbol) or less
	<b>#9773</b>	<b>Host4 password</b>	
			Set the password when connecting to the FTP server. ---Setting range--- 15 characters (alphanumeric or symbol) or less
	<b>#9774</b>	<b>Host4 directory</b>	
			Set the full path of a file to download from the FTP server. * Use "/" (slash) as a separator of directory for Windows type server as well. ---Setting range--- 31 characters (alphanumeric) or less
	<b>#9775</b>	<b>Host4 host type</b>	
			Not used.
	<b>#9776</b>	<b>Host 4 Wrd pos: name</b>	
			Not used.
	<b>#9777</b>	<b>Host 4 Wrd pos: size</b>	
			Not used.
	<b>#9778</b>	<b>Host 4 Wrd pos: Dir</b>	
			Not used.
	<b>#9779</b>	<b>Host 4 Wrd pos: cmnt</b>	
			Not used.
	<b>#9780</b>	<b>Host 4 Wrd num: cmnt</b>	
			Not used.
	<b>#9781</b>	<b>Host 4 no total siz</b>	
			Not used.
(PR)	<b>#9800</b>	<b>MES-IF DB IP addr</b>	<b>DB IP address</b>
			Not used.
(PR)	<b>#9801</b>	<b>MES-IF DB Port No</b>	<b>DB PORT No.</b>
			Not used.
(PR)	<b>#9802</b>	<b>MES-IF DB timeout</b>	<b>DB communication time-out (sec)</b>
			Not used.
(PR)	<b>#9803</b>	<b>MES-IF DB Type</b>	<b>DB type</b>
			Not used.
(PR)	<b>#9804</b>	<b>MES-IF DB Name</b>	<b>Database name</b>
			Not used.

<b>(PR)</b>	<b>#9805</b>	<b>MES-IF DB User</b>	<b>User name</b>
Not used.			
<b>(PR)</b>	<b>#9806</b>	<b>MES-IF DB Password</b>	<b>Password</b>
Not used.			
<b>(PR)</b>	<b>#9807</b>	<b>MES-IF DB Table</b>	<b>DB table name</b>
Not used.			
<b>(PR)</b>	<b>#11005</b>	<b>PC IP address</b>	<b>IP address setting</b>
Not used.			



## 15.7 Barrier Data (for L system only)

<b>#8300</b>	<b>P0 (for L system only)</b>
	Set the reference X-coordinates of the chuck and the tail stock barrier. Set the center coordinate of workpiece by the basic machine coordinate system. (radius value)
	<b>---Setting range---</b> -99999.999 to 99999.999 (mm)
<b>#8301</b>	<b>P1 (for L system only)</b>
	Set the area of the chuck and tail stock barrier. X axis: Set the coordinate from the workpiece center (P0). (radius value) Z axis: Set the coordinates in the basic machine coordinate system.
	<b>---Setting range---</b> -99999.999 to 99999.999 (mm)
<b>#8302</b>	<b>P2 (for L system only)</b>
	Set the area of the chuck and tail stock barrier. X axis: Set the coordinate from the workpiece center (P0). (radius value) Z axis: Set the coordinates in the basic machine coordinate system.
	<b>---Setting range---</b> -99999.999 to 99999.999 (mm)
<b>#8303</b>	<b>P3 (for L system only)</b>
	Set the area of the chuck and tail stock barrier. X axis: Set the coordinate from the workpiece center (P0). (radius value) Z axis: Set the coordinates in the basic machine coordinate system.
	<b>---Setting range---</b> -99999.999 to 99999.999 (mm)
<b>#8304</b>	<b>P4 (for L system only)</b>
	Set the area of the chuck and tail stock barrier. X axis: Set the coordinate from the workpiece center (P0). (radius value) Z axis: Set the coordinates in the basic machine coordinate system.
	<b>---Setting range---</b> -99999.999 to 99999.999 (mm)
<b>#8305</b>	<b>P5 (for L system only)</b>
	Set the area of the chuck and tail stock barrier. X axis: Set the coordinate from the workpiece center (P0). (radius value) Z axis: Set the coordinates in the basic machine coordinate system.
	<b>---Setting range---</b> -99999.999 to 99999.999 (mm)
<b>#8306</b>	<b>P6 (for L system only)</b>
	Set the area of the chuck and tail stock barrier. X axis: Set the coordinate from the workpiece center (P0). (radius value) Z axis: Set the coordinates in the basic machine coordinate system.
	<b>---Setting range---</b> -99999.999 to 99999.999 (mm)
<b>#8310</b>	<b>Barrier ON (for L system only)</b>
	Select whether to enable the chuck and tailstock barrier. 0: Disable (Setting from special display unit will be enabled) 1: Enable

<b>#8311</b>	<b>P7 (for L system only)</b>
	Set the area of the left spindle section. X axis: Set the coordinate from the workpiece center (P0). (radius value) Z axis: Set the coordinates in the basic machine coordinate system. <b>---Setting range---</b> -99999.999 to 99999.999 (mm)
<b>#8312</b>	<b>P8 (for L system only)</b>
	Set the area of the left spindle section. X axis: Set the coordinate from the workpiece center (P0). (radius value) Z axis: Set the coordinates in the basic machine coordinate system. <b>---Setting range---</b> -99999.999 to 99999.999 (mm)
<b>#8313</b>	<b>P9 (for L system only)</b>
	Set the area of the right spindle section. X axis: Set the coordinate from the workpiece center (P0). (radius value) Z axis: Set the coordinates in the basic machine coordinate system. <b>---Setting range---</b> -99999.999 to 99999.999 (mm)
<b>#8314</b>	<b>P10 (for L system only)</b>
	Set the area of the right spindle section. X axis: Set the coordinate from the workpiece center (P0). (radius value) Z axis: Set the coordinates in the basic machine coordinate system. <b>---Setting range---</b> -99999.999 to 99999.999 (mm)
<b>#8315</b>	<b>Barrier Type (L) (for L system only)</b>
	Select the shape of the left chuck and tailstock barrier. 0: No area 1: Chuck 2: Tailstock
<b>#8316</b>	<b>Barrier Type (R) (for L system only)</b>
	Select the shape of the right chuck and tailstock barrier. 0: No area 1: Chuck 2: Tailstock
<b>#8317</b>	<b>ELIV. AX. Name (for L system only)</b>
	Set the name of the delivery axis when the right chuck and tailstock barrier is movable. When using the multi-part system method and the delivery axis is an axis in the other part system, designate the axis including the part system as 1A, 1B or 2A, 2B. If the part system is not designated as A and B, the set part system will be used. <b>---Setting range---</b> A/B/.. (axis name)  1A/1B/.. 2A/2B/.. (with part system designated)  0: Cancel

---

**#8318      Stock Angle (L) (for L system only)**

---

Set the angle for the left tailstock end section.

The angle will be interpreted as 90° if there is no setting (when "0" is set).

**---Setting range---**

0 to 180 (°)

0: 90° (default)

---

**#8319      Stock Angle (R) (for L system only)**

---

Set the angle for the right tailstock end section.

The angle will be interpreted as 90° if there is no setting (when "0" is set).

**---Setting range---**

0 to 180 (°)

0: 90° (default)

## 15.8 High-accuracy Control Parameters

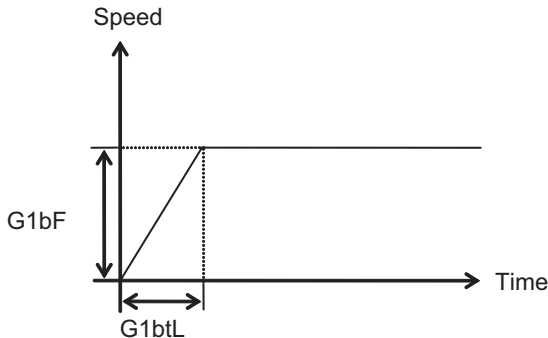
<b>#1149</b>	<b>cireft</b>	<b>Arc deceleration speed change</b>
Select whether to decelerate at the arc entrance or exit. 0: Not decelerate 1: Decelerate		
<b>#1205</b>	<b>G0bdcc</b>	<b>Acceleration and deceleration before G0 interpolation</b>
0: Post-interpolation acceleration/deceleration is applied to G00. 1: Pre-interpolation acceleration/deceleration is applied to G00 even in the high accuracy control mode. 2: Rapid traverse constant-gradient multi-step acceleration/deceleration is enabled.  When the multi-part system simultaneous high-accuracy control option is enabled, "1" can be set for the 2nd part system and the following.		
<b>#1206</b>	<b>G1bF</b>	<b>Maximum speed</b>
Set a cutting feedrate when applying pre-interpolation acceleration/deceleration. When high-accuracy control time constant expansion is valid, set the maximum of cutting feed clamp speed of each axis.  <b>---Setting range---</b> 1 to 999999 (mm/min)		
<b>#1207</b>	<b>G1btL</b>	<b>Time constant</b>
Set a cutting feed time constant when applying pre-interpolation acceleration/deceleration. When set to "0", the time constant will be clamped at 1ms.		
		
<b>---Setting range---</b> Without high-accuracy control time constant expansion: 1 to 5000 (ms) With high-accuracy control time constant expansion: 1 to 30000 (ms)		
<b>Cutting feed Acc Cutting feed acceleration</b> Displays cutting feed acceleration.		
<b>#1209</b>	<b>cirdcc</b>	<b>Arc deceleration speed</b>
Set the deceleration speed at the arc entrance or exit.  <b>---Setting range---</b> 1 to 999999 (mm/min)		
<b>#1568</b>	<b>SfiltG1</b>	<b>G01 soft acceleration/deceleration filter</b>
Set the filter time constant for smoothly changing the acceleration rate for the cutting feed acceleration/deceleration in pre-interpolation acceleration/deceleration. - Notch frequency Hz Displays the notch frequency (Hz) for the S-pattern filter set in "#1568 SfiltG1" (G01 soft acceleration/deceleration filter).  <b>---Setting range---</b> 0 to 200 (ms)		

#1569	SfiltG0	G00 soft acceleration/deceleration filter
Set the filter time constant for smoothly changing the acceleration rate for the rapid traverse acceleration/deceleration in pre-interpolation acceleration/deceleration. ---Setting range--- 0 to 200 (ms)		
#1570	Sfilt2	Soft acceleration/deceleration filter 2
Set the filter time constant for smoothly changing the acceleration rate in pre-interpolation acceleration/deceleration. This will be disabled when "0" or "1" is set. - Notch frequency Hz Displays the notch frequency (Hz) for the S-shape filter set in "#1570 Sfilt2" (Soft acceleration/deceleration filter 2). ---Setting range--- 0 to 200 (ms)		
#1571	SSSdis	SSS control adjustment coefficient fixed value selection
Fix the shape recognition range for SSS control. ---Setting range--- 0/1		
#7914	ROT_PREFILT	Rotary axis prefilter time constant
Not used. Set to "0".		
#8019	R COMP	

Set a compensation coefficient for reducing a control error in the reduction of a corner roundness and arc radius.  
 The larger the set value is, the smaller the theoretical error will be. However, since the speed at the corner goes down, the cycle time will be extended.  
 Coefficient = 100 - setting value  
 (Note) This function will be enabled when "#8021 COMP\_CHANGE" is set to "0".

---Setting range---  
 0 to 99 (%)

**Theoretical radius decrease error amount**

Displays the theoretical radius decrease error amount,  $\Delta R$ (mm), from the automatic calculation by NC.

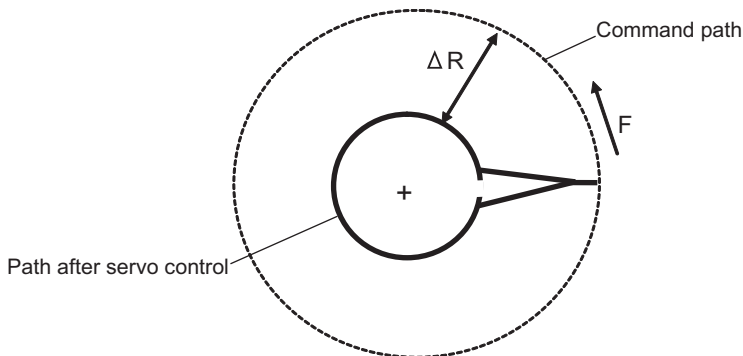

Theoretical radius decrease amount in arc

**R5mm arc deceleration speed**

Displays a deceleration speed (mm/min) along an arc of 5 (mm) radius.

**R1mm arc deceleration speed**

Displays a deceleration speed(mm/min) along an arc of 1 (mm) radius.

**#8020 DCC ANGLE**

Set the minimum value of an angle (external angle) that should be assumed to be a corner.

When an inter-block angle (external angle) in high-accuracy mode is larger than the set value, it will be determined as a corner and the speed will go down to sharpen the edge.

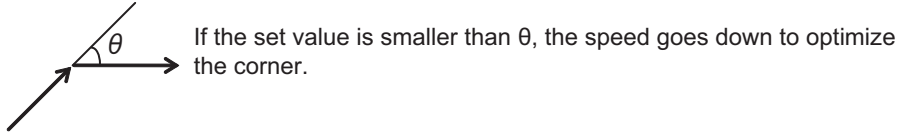

(Note) If "0" is set, it will be handled as "5" degrees.

**---Setting range---**

0 to 89 (°)

0: 5 degree (Equals to setting "5")

**Theoretical corner dull amount**

Displays the corner dull amount  $\Delta c$ (mm) in respect to the corner's angle (external angle)  $\theta$ (°).

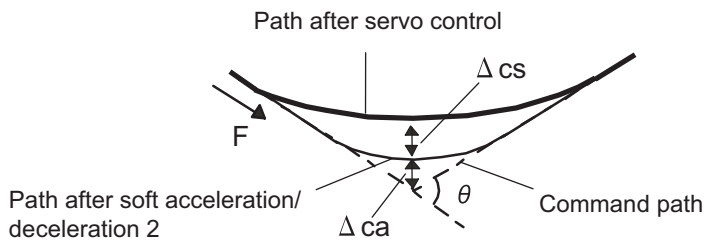

Theoretical roundness amount at corner

ca(mm): Error ( $\Delta$ ) caused by the soft acceleration/deceleration 2

cs(mm): Error ( $\Delta$ ) caused by the servo system

**Corner deceleration speed**

Display corner deceleration speed  $c$  (mm/min) for the corner of the angle (external angle) with  $\theta$ (°).

**Theoretical dull amount at 90 degree**

Display corner dull amount when the angle is 90 degree.

**Corner deceleration speed at 90 degree**

Display corner deceleration speed when the angle is 90 degree.

**#8021 COMP\_CHANGE**

Select whether to share or separate the compensation coefficient at the corner/curve during the high-accuracy control mode.

0: Share ("#8019 R COMP" is applied.)

1: Separate

\* Corner: #8022 CORNER COMP

\* Curve: #8023 CURVE COMP

(Note) Set "1" when using SSS/EasySSS control.

<b>#8022</b>	<b>CORNER COMP</b>
<p>Set the compensation coefficient to further reduce or increase the roundness at the corner during the high-accuracy control mode.</p> <p>Coefficient = 100 - setting value</p> <p>(Note) This is valid when "#8021 COMP CHANGE" is set to "1".</p> <p>Reference to "#8020 Corner decreasing speed "for theoretical corner roundness amount, corner decreasing speed, theoretical 90 degree dull amount, 90 degree corner decreasing speed.</p> <p>---Setting range---</p> <p>-1000 to 99 (%)</p>	
<b>#8023</b>	<b>CURVE COMP</b>
<p>Set the compensation coefficient to further reduce or increase the radius reduction amount at the curve (arc, involute, spline) during the high-accuracy control mode.</p> <p>Coefficient = 100 - setting value</p> <p>(Note) This is valid when "#8021 COMP CHANGE" is set to "1".</p> <p>For theoretical radius reduction error amount, R5mm arc deceleration speed and R1mm arc deceleration speed, refer to "#8019 R COMP".</p> <p>---Setting range---</p> <p>-1000 to 99 (%)</p>	
<b>#8025</b>	<b>SPLINE ON</b>
<p>For M system only.</p> <p>Specify whether to enable the fine spline function.</p> <p>0: Disable the fine spline function.</p> <p>1: Enable the fine spline function.</p> <p>Spline interpolation will be valid during G61.2 modal regardless of this setting.</p>	
<b>#8026</b>	<b>CANCEL ANG. (for M system only)</b>
<p>Set the angle where the spline interpolation is temporarily canceled.</p> <p>When the angle made by blocks exceeds this parameter setting value, spline interpolation will be canceled temporarily. In consideration of the pick feed, set a value a little smaller than the pick feed angle.</p> <p>---Setting range---</p> <p>0 to 180 (°)</p> <p>0: 180 (°)</p>	
<b>#8027</b>	<b>Toler-1 (for M system only)</b>
<p>Set the maximum chord error (tolerance) in a block that includes an inflection point. Set the tolerance applicable when the applicable block is developed to fine segments by CAM. (normally about 10 μm)</p> <p>When "0.000" is set, the applicable block will be linear.</p> <p>---Setting range---</p> <p>0.000 to 100.000 (mm)</p>	
<b>#8028</b>	<b>Toler-2 (for M system only)</b>
<p>Set the maximum chord error (tolerance) in a block that includes no inflection point. Set the tolerance applicable when the applicable block is developed to fine segments by CAM. (normally about 10 μm)</p> <p>When "0.000" is set, the applicable block will be linear.</p> <p>---Setting range---</p> <p>0.000 to 100.000 (mm)</p>	
<b>#8029</b>	<b>FairingL (for M system only)</b>
<p>Set the length of the block subject to fairing.</p> <p>(Enabled when "#8033 Fairing ON" is set to "1".)</p> <p>---Setting range---</p> <p>0 to 100.000 (mm)</p>	

<b>#8030</b>	<b>MINUTE LENGHS (for M system only)</b>
	<p>Set the fine-segment length where the spline interpolation is temporarily canceled.</p> <p>When the length of one block exceeds this parameter setting value, spline interpolation is canceled temporarily and linear interpolation is performed. Set a value a little smaller than one block length of the program.</p> <p>If "-1" is set, spline interpolation will be performed regardless of block length.</p> <p><b>---Setting range---</b></p> <p>-1 to 127 (mm)</p> <p>0: 1 (mm)</p>
<b>#8033</b>	<b>Fairing ON (for M system only)</b>
	<p>Select whether or not to use the fairing or smooth fairing function.</p> <p>0: Use neither of them</p> <p>1: Use the fairing function</p> <p>2: Use the smooth fairing function</p>
<b>#8034</b>	<b>AccClamp ON (for M system only)</b>
	<p>Select the method for clamping the cutting speed.</p> <p>0: Clamp with parameter "#2002 clamp" or the corner deceleration function.</p> <p>1: Clamp the cutting speed with acceleration judgment. (Enabled when "#8033 Fairing ON" is set to "1".)</p>
<b>#8036</b>	<b>CordecJudge (for M system only)</b>
	<p>Select the condition to decide a corner.</p> <p>0: A corner is decided from the angle of the neighboring block.</p> <p>1: A corner is decided from the angle of the neighboring block, excluding minute blocks. (Enabled when "#8033 Fairing ON" is set to "1".)</p>
<b>#8037</b>	<b>CorJudgeL (for M system only)</b>
	<p>Set the length of the block to be excluded when deciding a corner.</p> <p>(Enabled when "#8036 CordecJudge" is set to "1".)</p> <p><b>---Setting range---</b></p> <p>0 to 99999.999 (mm)</p>
<b>#8038</b>	<b>Path recog. range</b>
	<p>Path recognition range</p> <p>Specify the range to recognize the tool paths adjoining to the command position when the smooth fairing function is ON.</p> <p>If "0" is set, the range will be 1.000 (mm).</p> <p><b>---Setting range---</b></p> <p>0 to 100.000 (mm)</p>
<b>#8039</b>	<b>Comp. range limit</b>
	<p>Compensation distance tolerance</p> <p>Specify the upper limit of the distance between the command position and compensation position when the smooth fairing function is ON.</p> <p>If you specify a negative value, operation is conducted with no tolerance limit.</p> <p>If "0" is set, the tolerance will be 0.005 (mm).</p> <p><b>---Setting range---</b></p> <p>-1.000 to 100.000 (mm)</p>
<b>(PR) #8040</b>	<b>High-SpeedAcc</b>
	<p>High-speed high-accuracy control-enabled part system</p> <p>Select whether to enable the simultaneous use of the high-accuracy control and high-speed machining mode (including the high-speed high-accuracy control I and II) for each part system.</p> <p>0: Not enable</p> <p>1: Enable</p> <p>"1" can be set for up to two part systems. If you set "1" for three or more part systems, the alarm (Y51 0032) will result.</p>



<b>#8090</b>	<b>SSS ON (for M system only)</b>
	Set whether to enable the SSS control with G05 P10000. 0: Disable 1: Enable
<b>#8091</b>	<b>StdLength (for M system only)</b>
	Set the maximum value of the range for recognizing the shape. To eliminate the effect of steps or errors, etc., set a large value. To enable sufficient deceleration, set a small value. If "0.000" is set, the standard value (1.000mm) will be applied. ---Setting range--- 0 to 100.000 (mm)
<b>#8092</b>	<b>ClampCoeff (for M system only)</b>
	Set the clamp speed at the curved section configured of fine segments. Coefficient = $\sqrt{\text{setting value}}$ ---Setting range--- 1 to 100
<b>#8093</b>	<b>StepLeng (for M system only)</b>
	Set the width of the step at which the speed is not to be decelerated. (Approximately the same as the CAM path difference [Tolerance].) If "0" is set, the standard value (5 $\mu$ m) will be applied. If a minus value is set, the speed will decelerate at all minute steps. ---Setting range--- -1.000 to 0.100 (mm)
<b>#8094</b>	<b>DccWaitAdd (for M system only)</b>
	Set the time to wait for deceleration when the speed FB does not drop to the clamp speed. ---Setting range--- 0 to 100 (ms)
<b>#8096</b>	<b>Deceler. coeff. ON</b>
	Deceleration coefficient for SSS control ON Select whether to enable the speed coefficients ("#8097 Corner deceleration coefficient for SSS control", "#8098 Arc clamp speed coefficient for SSS control") that are used for compensating for a path error and clamp speed under SSS control. 0: Disable 1: Enable
<b>#8097</b>	<b>Corner decel coeff</b>
	Corner deceleration coefficient for SSS control Specify the compensation coefficient to be used for adjusting a path error and clamp speed at a corner under SSS control. This parameter is enabled during SSS control. Thus set this parameter if you wish to use different compensation coefficients according to ON/OFF of SSS control (If you wish to adjust a path error and clamp speed at a corner, use "#8022 CORNER COMP"). If the setting value is smaller, the theoretical path error will decrease, but the cycle time may be longer because the corner deceleration speed will slow down. Note that this parameter is enabled when "#8096 Deceleration coefficient for SSS control ON" is "1". When "0" is set in this parameter, the standard value (300%) is applied. ---Setting range--- 0 to 2000 (%)

<b>#8098</b>	<b>Arc clamp spd coef</b>	
	Arc clamp speed coefficient for SSS control	
	Specify the compensation coefficient to be used for adjusting a path error and clamp speed on an arc under SSS control. This parameter is enabled during SSS control. Thus set this parameter if you wish to use different compensation coefficients according to ON/OFF of SSS control (If you wish to adjust a path error and clamp speed on an arc, use "#8023 CURVE COMP").	
	If the setting value is smaller, the theoretical path error will decrease, but the cycle time may be longer because the arc clamp speed will slow down.	
	Note that this parameter is enabled when "#8096 Deceleration coefficient for SSS control ON" is "1".	
	When "0" is set in this parameter, the standard value (100%) is applied.	
	<b>---Setting range---</b>	
	0 to 2000 (%)	
<b>#12051</b>	<b>Jerk_filtG1</b>	<b>G01 jerk filter</b>
	Specify the time constant of filter that is used for smoothing the change of jerk when pre-interpolation acceleration/deceleration is performed in cutting feed.	
	This filter causes no path error, as the filter is applied to the resultant speed calculated before interpolation.	
	If you specify the jerk filter time constant, the time constants of each filter will be as follows:	
	- S-shape filter time constant	
	"#1568 SfiltG1" - "Jerk_filtG1"	
	- Jerk filter time constant	
	"Jerk_filtG1"	
	<b>---Setting range---</b>	
	0 to 50 (ms)	
<b>#12052</b>	<b>Jerk_filtG0</b>	<b>G00 jerk filter</b>
	Specify the time constant of filter that is used for smoothing the change of jerk when pre-interpolation acceleration/deceleration is performed in cutting feed.	
	This filter causes no path error, as the filter is applied to the resultant speed calculated before interpolation.	
	If you specify the jerk filter time constant, the time constants of each filter will be as follows:	
	- S-shape filter time constant	
	"#1569 SfiltG0" - "Jerk_filtG0"	
	- Jerk filter time constant	
	"Jerk_filtG0"	
	<b>---Setting range---</b>	
	0 to 50 (ms)	
<b>#12053</b>	<b>EachAxAccCtrl</b>	<b>Enable axis-specific acceleration tolerance control</b>
	Not used. Set to "0".	
<b>#12060</b>	<b>VblAccPreInt</b>	<b>Variable-acceleration pre-interpolation acceleration/deceleration ON</b>
	Not used. Set to "0".	
<b>#12066</b>	<b>Tolerance ctrl ON</b>	
	Select whether to enable the tolerance control.	
	0: Disable	
	1: Enable	
	(Note) Tolerance control is available only under SSS control.	
	To enable this function, set "#8090 SSS ON" to "1".	

<b>#12067</b>	<b>Tolerance spd coef</b>	
		<p>Set the compensation coefficient to adjust a path error or clamp speed in the corner while tolerance control is ON.</p> <p>This parameter is enabled during tolerance control. Thus set this parameter if you wish to use different clamp speed according to ON/OFF of tolerance control.</p> <p>When "0" is set in this parameter, the standard value (100%) is applied.</p> <p><b>---Setting range---</b></p> <p>0 to 2000 (%)</p>
<b>#12068</b>	<b>Smoothing range</b>	
		<p>Spline interpolation 2: Smoothing range</p> <p>Normally set "0" in this parameter.</p> <p>If you run a program with micro segments and its reciprocating paths are uneven, set the parameter to about 3 to 5 times the length of the programmed segments.</p> <p><b>---Setting range---</b></p> <p>0.000 to 10.000 (mm)</p>
<b>#12069</b>	<b>Corner angle</b>	
		<p>Tolerance control: Corner recognition angle</p> <p>Specify the corner recognition angle. Normally set to "0".</p> <p><b>---Setting range---</b></p> <p>0.000 to 180.000 (°)</p>
<b>#12070</b>	<b>Sfilt2_tol</b>	<b>Tolerance control: Soft acceleration/deceleration filter 2</b>
		<p>Specify the time constant of the filter that smoothes out fluctuations in acceleration under the tolerance control.</p> <p>Basically set to 0.</p> <p><b>---Setting range---</b></p> <p>0 to 200 (ms)</p>

## 15.9 High-accuracy Control Axis Parameters

<b>#2001</b>	<b>rapid</b>	<b>Rapid traverse rate</b>
Set the rapid traverse feedrate for each axis. (Note) The maximum value to be set depends on the machine specifications.		
---Setting range---		
1 to 1000000 (mm/min)		
<b>#2002</b>	<b>clamp</b>	<b>Cutting feedrate for clamp function</b>
Set the maximum cutting feedrate for each axis. Even if the feedrate in G01 exceeds this value, the clamp will be applied at this feedrate.		
---Setting range---		
1 to 1000000 (mm/min)		
<b>#2010</b>	<b>fwd_g</b>	<b>Feed forward gain</b>
Set a feed forward gain for pre-interpolation acceleration/deceleration. The larger the set value, the smaller the theoretical control error will be. However, if a machine vibration occurs, set the smaller value.		
---Setting range---		
0 to 200 (%)		
<b>#2068</b>	<b>G0fwdg</b>	<b>G00 feed forward gain</b>
Set a feed forward gain for G00 pre-interpolation acceleration/deceleration. The larger the setting value, the shorter the positioning time during in-position checking. If a machine vibration occurs, set the smaller value.		
---Setting range---		
0 to 200 (%)		
<b>#2096</b>	<b>crncsp</b>	<b>Minimum corner deceleration speed</b>
Set the minimum clamp speed for corner deceleration in the high-accuracy control mode. Normally set "0".  (Note) This parameter is invalid during SSS control.		
---Setting range---		
0 to 1000000 (mm/min)		
<b>#2109</b>	<b>Rapid (H-precision)</b>	<b>Rapid traverse rate for high-accuracy control mode</b>
Set the rapid traverse rate for each axis in the high-accuracy control mode. When 0 is set, "#2001 rapid" is used.		
---Setting range---		
0 to 1000000 (mm/min)		
<b>#2110</b>	<b>Clamp (H-precision)</b>	<b>Cutting feed clamp speed for high-accuracy control mode</b>
Set the cutting feed maximum speed for each axis in the high-accuracy control mode. When 0 is set, "#2002 clamp" is used.		
---Setting range---		
0 to 1000000 (mm/min)		
<b>#2157</b>	<b>G1bFx</b>	<b>Maximum axis-specific pre-interpolation cutting feed rate</b>
Not used. Set to "0".		
<b>#2158</b>	<b>G1btLx</b>	<b>Axis-specific pre-interpolation cutting feed time constant</b>
Not used. Set to "0".		

#2159	comp <sub>x</sub>	Accuracy coefficient for each axis
		<p>Specify the compensation coefficient to be used for adjusting a path error and clamp speed at a corner for each axis during the high-accuracy control mode. If the setting value is larger, the edge accuracy will improve, but the cycle time may be longer because the corner speed will slow down.</p> <p>This parameter is disabled when the axis-specific acceleration tolerance control is OFF.</p> <p><b>---Setting range---</b></p> <p>-1000 to 99 (%)</p>

## 15.10 Operation Parameters

---

### #8901 Counter type 1

---

Select the type of the following counters on the Monitor screen.

- ♦Normal display: Upper-left counter
- ♦2-, 3- or 4-part system simultaneous display (four counters): Upper-left counter
- ♦2-, 3- or 4-part system simultaneous display (two counters): Upper counter
- ♦2-, 3- or 4-part system simultaneous display (one counter): Counter

Either relative position or tip work position is displayed by default.

(Note 1) 3- or 4-part system simultaneous display is not available.

(Note 2) Tip work position is displayed when 5-axis-related option is ON.

- 1: Current position
- 2: Workpiece coordinate position
- 3: Machine position
- 4: Program position
- 8: Remain command
- 9: Manual interrupt amount
- 10: Next command
- 11: Restart position
- 12: Remain distance
- 16: Tip workpiece coordinate position
- 18: Tool axis movement
- 19: Tip machine position
- 20: Relative position
- 21: Table coordinate position
- 22: Workpiece installation position
- 23: Inclined surface coordinate position

**---Setting range---**

1 to 27

**#8902 Counter type 2**

Select the type of the following counters on the Monitor screen.

- ♦Normal display: Lower-left counter
- ♦2-, 3- or 4-part system simultaneous display (four counters): Lower-left counter
- ♦2-, 3- or 4-part system simultaneous display (two counters): Lower counter

Programmed position is displayed by default.

(Note 1) 3- or 4-part system simultaneous display is not available.

- 1: Current position
- 2: Workpiece coordinate position
- 3: Machine position
- 4: Program position
- 8: Remain command
- 9: Manual interrupt amount
- 10: Next command
- 11: Restart position
- 12: Remain distance
- 16: Tip workpiece coordinate position
- 18: Tool axis movement
- 19: Tip machine position
- 20: Relative position
- 21: Table coordinate position
- 22: Workpiece installation position
- 23: Inclined surface coordinate position

**---Setting range---**

1 to 27

**#8903 Counter type 3**

Select the type of the following counters on the Monitor screen.

- ♦Normal display: Upper-right counter
- ♦2-, 3- or 4-part system simultaneous display (four counters): Upper-right counter

Remaining command is displayed by default.

(Note 1) 3- or 4-part system simultaneous display is not available.

- 1: Current position
- 2: Workpiece coordinate position
- 3: Machine position
- 4: Program position
- 8: Remain command
- 9: Manual interrupt amount
- 10: Next command
- 11: Restart position
- 12: Remain distance
- 16: Tip workpiece coordinate position
- 18: Tool axis movement
- 19: Tip machine position
- 20: Relative position
- 21: Table coordinate position
- 22: Workpiece installation position
- 23: Inclined surface coordinate position

**---Setting range---**

1 to 27

**#8904 Counter type 4**

Select the type of the following counters on the Monitor screen.

- ♦Normal display: Lower-right counter
- ♦2-, 3- or 4-part system simultaneous display (four counters): Lower-right counter

Next command is displayed by default.

(Note 1) 3- or 4-part system simultaneous display is not available.

- 1: Current position
- 2: Workpiece coordinate position
- 3: Machine position
- 4: Program position
- 8: Remain command
- 9: Manual interrupt amount
- 10: Next command
- 11: Restart position
- 12: Remain distance
- 16: Tip workpiece coordinate position
- 18: Tool axis movement
- 19: Tip machine position
- 20: Relative position
- 21: Table coordinate position
- 22: Workpiece installation position
- 23: Inclined surface coordinate position

**---Setting range---**

1 to 27

**#8905 Counter type 5**

Select the type of counter on the Monitor screen (Simple display).

Either relative position or tip work position is displayed by default.

(Note 1) Tip work position is displayed when 5-axis-related option or program format switch option is ON.

- 1: Current position
- 2: Workpiece coordinate position
- 3: Machine position
- 4: Program position
- 8: Remain command
- 9: Manual interrupt amount
- 10: Next command
- 11: Restart position
- 12: Remain distance
- 16: Tip workpiece coordinate position
- 18: Tool axis movement
- 19: Tip machine position
- 20: Relative position
- 21: Table coordinate position
- 22: Workpiece installation position
- 23: Inclined surface coordinate position

**---Setting range---**

1 to 27

**#8906 Counter type 6**

Not used. Set to "0".

**#8909 Aut/Manual switch**

Not used.



<b>#8910</b>	<b>Edit undo</b>
	Set whether to enable the Undo function during program edit on the Monitor screen or Edit screen. 0: Disable 1: Enable (Note) This parameter is valid for M800W/M800S Series.
<b>#8913</b>	<b>Touch panel sense</b>
	Not used.
<b>#8914</b>	<b>Auto Top search</b>
	Select the operation method for restart search type 2. 0: It is necessary to set the top search position arbitrarily. 1: The restart search is executed from O No. that is designated as head.
<b>#8920</b>	<b>3D tool ofs select</b>
	Not used.
<b>#8921</b>	<b>Mass Edit select</b>
	Not used.
<b>#8922</b>	<b>T-reg-dup check</b>
	Set whether to enable the duplication check in registering tools to magazine pots, and in setting tool Nos. for spindle/standby. 0: Duplication check valid for all valid magazines 1: Duplication check invalid 2: Duplication check valid only for the selected magazine
<b>(PR) #8923</b>	<b>Hide Edit-IO menu</b>
	Set whether to enable the edit-in/out menu. When disabled, the edit-input/output menu won't appear. However, the maintenance-in/out menu is always enabled regardless of this parameter setting. 0: Enable 1: Disable
<b>#8924</b>	<b>Meas. confirm msg</b>
	Select whether to display a confirming message when attempting to write compensation data for tool measurement, or coordinate system data for workpiece measurement. However, the confirmation message will not appear in L system tool measurement simple mode "#8957 T meas (L)-Simple". 0: Not display a confirming message 1: Display a confirming message
<b>#8925</b>	<b>SP on 1st part sys</b>
	Select which spindle to display in the 1st part system window for the 2-, 3- or 4-part system simultaneous display. (Note 1) If you select "00" for the 2-, 3- or 4-part system simultaneous display, the default display is used (1st spindle on the upper side and 2nd spindle on the lower side). (Note 2) If you set the same number as, or a greater number than the setting of "#1039 spinno", or if the high- or low-order setting is "0", the 1st spindle is displayed. (Note 3) If you set the low-order to F, the screen shows the actual rotation speed, command speed and load meter of the high-order spindle. Note that for the 4-counter display in 4-part system simultaneous display, even if the low-order is not F, the screen shows the actual rotation speed, command speed and load meter of the high-order and low-order spindles. (Note 4) 3- or 4-part system simultaneous display is not available. <b>---Setting range---</b> High-order (Select an upper side spindle.) : 0 to 8 Low-order (Select a lower side spindle.) : 0 to 8, F

#8926	<b>SP on 2nd part sys</b>
<p>Select which spindle to display in the 2nd part system window for the 2-, 3- or 4-part system simultaneous display.</p>	
<p>(Note 1) If you select "00" for the 2-, 3- or 4-part system simultaneous display, the default display is used (1st spindle on the upper side and 2nd spindle on the lower side).</p>	
<p>(Note 2) If you set the same number as, or a greater number than the setting of "#1039 spinno", or if the high- or low-order setting is "0", the 1st spindle is displayed.</p>	
<p>(Note 3) If you set the low-order to F, the screen shows the actual rotation speed, command speed and load meter of the high-order spindle.</p>	
<p>Note that for the 4-counter display in 4-part system simultaneous display, even if the low-order is not F, the screen shows the actual rotation speed, command speed and load meter of the high-order and low-order spindles.</p>	
<p>(Note 4) 3- or 4-part system simultaneous display is not available.</p>	
<p><b>---Setting range---</b></p>	
<p>High-order (Select an upper side spindle.) : 0 to 8</p>	
<p>Low-order (Select a lower side spindle.) : 0 to 8, F</p>	
#8927	<b>SP on 3rd part sys</b>
<p>Select which spindle to display in the 3rd part system window for the 2-, 3- or 4-part system simultaneous display.</p>	
<p>(Note 1) If you select "00" for the 2-, 3- or 4-part system simultaneous display, the default display is used (1st spindle on the upper side and 2nd spindle on the lower side).</p>	
<p>(Note 2) If you set the same number as, or a greater number than the setting of "#1039 spinno", or if the high- or low-order setting is "0", the 1st spindle is displayed.</p>	
<p>(Note 3) If you set the low-order to F, the screen shows the actual rotation speed, command speed and load meter of the high-order spindle.</p>	
<p>Note that for the 4-counter display in 4-part system simultaneous display, even if the low-order is not F, the screen shows the actual rotation speed, command speed and load meter of the high-order and low-order spindles.</p>	
<p>(Note 4) 3- or 4-part system simultaneous display is not available.</p>	
<p><b>---Setting range---</b></p>	
<p>High-order (Select an upper side spindle.) : 0 to 8</p>	
<p>Low-order (Select a lower side spindle.) : 0 to 8, F</p>	
#8928	<b>SP on 4th part sys</b>
<p>Select which spindle to display in the 4th part system window for the 2-, 3- or 4-part system simultaneous display.</p>	
<p>(Note 1) If you select "00" for the 2-, 3- or 4-part system simultaneous display, the default display is used (1st spindle on the upper side and 2nd spindle on the lower side).</p>	
<p>(Note 2) If you set the same number as, or a greater number than the setting of "#1039 spinno", or if the high- or low-order setting is "0", the 1st spindle is displayed.</p>	
<p>(Note 3) If you set the low-order to F, the screen shows the actual rotation speed, command speed and load meter of the high-order spindle.</p>	
<p>Note that for the 4-counter display in 4-part system simultaneous display, even if the low-order is not F, the screen shows the actual rotation speed, command speed and load meter of the high-order and low-order spindles.</p>	
<p>(Note 4) 3- or 4-part system simultaneous display is not available.</p>	
<p><b>---Setting range---</b></p>	
<p>High-order (Select an upper side spindle.) : 0 to 8</p>	
<p>Low-order (Select a lower side spindle.) : 0 to 8, F</p>	
#8929	<b>Disable=INPUT:comp</b>
<p>Disable [=INPUT] menu for tool compensation and workpiece coordinate offset values. Fix the setting method to the incremental value input.</p>	
<p>0: Enable</p>	
<p>1: Disable</p>	

	<b>#8930</b>	<b>Disable=INPUT:var</b>
		Disable [=INPUT] menu for common variables. 0: Enable 1: Disable
	<b>#8931</b>	<b>Display/Set limit</b>
		Select the restriction of the connected NC's screen display/settings on/from the remote control tool (NC Monitor2). 0: Permit the screen display/settings 1: Permit the screen display only 2: Restrict the connection
<b>(PR)</b>	<b>#8932</b>	<b>Hide measure scrn</b>
		Select whether to display the tool measurement screen and workpiece measurement screen. 0: Display 1: Not display  (Note) If the "#1 1056 Workpiece coordinate system shift OFF" is "0" for the L system, the screen is displayed as the workpiece coordinate system shift screen even when this parameter is set to "1".
	<b>#8933</b>	<b>Disable lngth comp</b>
		Set whether to disable the setting of tool shape compensation amount. 0: Enable the setting 1: Disable the setting  The shape compensation amount covers the following data according to the tool compensation type. • Compensation type I ("1" in "#1037 cmdtyp(command type)") ... Compensation amount (the sum of shape compensation and wear compensation amount) • Compensation type II ("2" in "#1037 cmdtyp(command type)") ... Length dimension and radius dimension • Compensation type III ("3" in "#1037 cmdtyp(command type)") ... Tool length and tool nose R
	<b>#8934</b>	<b>Disable wear comp</b>
		Select whether to disable the setting of tool wear compensation amount. 0: Enable the setting 1: Disable the setting  The wear compensation amount covers the following data according to the tool compensation type. • Compensation type I ("1" in "#1037 cmdtyp(command type)") ... This parameter is disabled. • Compensation type II ("2" in "#1037 cmdtyp(command type)") ... Length wear and radius wear • Compensation type III ("3" in "#1037 cmdtyp(command type)") ... Tool wear and tool nose wear
	<b>#8935</b>	<b>W COORD CONFIRM</b>
		Select whether to display confirmation message when setting workpiece coordinate system offset in [Easy setting] menu. 0: Not display 1: Display
	<b>#8936</b>	<b>Delete leading 0</b>
		In creating a file, or in transferring a file, if the file name of the new file, or the file name of the transfer destination consists only of numerical figures, 0 of the file name head will be deleted from the name. 0: Designated file name (0 remains in the file name) 1: 0 will be deleted from the file name
	<b>#8937</b>	<b>File sort volume</b>
		Not used.

	<b>#8938</b>	<b>Edit-Not show Prg</b>
		Select whether to enable the automatic display on the Edit screen, when selected, of the programs searched by operation/check search or the MDI programs in MDI mode. 0: Enable the automatic display 1: Disable the automatic display
	<b>#8939</b>	<b>Undo confirm msg</b>
		Display a confirming message when operating the [Undo] menu. 0: Not display a confirming message 1: Display a confirming message
	<b>#8940</b>	<b>Set select display</b>
		Select what to display in the selectable display area. 0: Common variable 1: Local variable 2: Workpiece coordinate system offset 3: All spindles' rotation speed 4: Expanded counters 5: Tool center coordinate display 6: Tool compensation amount  (Note1) Tool center coordinate display is available only when any of the 5-axis related options is enabled.
<b>(PR)</b>	<b>#8941</b>	<b>ABS/INC for T-ofs</b>
		Enable switching the method to set tool compensation data (absolute/incremental value) with INPUT key. 0: Fix it to the absolute value input. 1: Enable to switch between absolute and incremental value input.
<b>(PR)</b>	<b>#8942</b>	<b>\$1 color</b>
		Set the color to be shown on the top-left of screen and window title for the 1st part system. This enables switching the color patterns for each part system. When set to the values "1" to "8", the part system name is shown in the form of button image. When set to "0", the settings between #8943 (#8962) and #8945 (#8965) is disabled and the screen is shown by the default color pattern for all the part systems. (Note) When set to "0" or "1", the color is determined by the setting of "#11060 Screen theme color". 0: Theme color (no button image) (default) 1: Theme color 2: Pink 3: Light blue 4: Orange 5: Green 6: Fuchsia 7: YellowGreen 8: Brown

<b>(PR)</b>	<b>#8943</b>	<b>\$2 color</b>
<p>Set the color to be shown on the top-left of screen and window title for the 2nd part system. This enables switching the color patterns for each part system.</p> <p>When set to the values "1" to "8", the part system name is shown in the form of button image.</p> <p>(Note 1) Enabled when "#8942 \$1 color" is set to the values "1" to "8".</p> <p>(Note 2) When set to "1", the color is determined by the setting of "#11060 Screen theme color".</p> <ul style="list-style-type: none"> <li>1: Theme color (default)</li> <li>2: Pink</li> <li>3: Light blue</li> <li>4: Orange</li> <li>5: Green</li> <li>6: Fuchsia</li> <li>7: YellowGreen</li> <li>8: Brown</li> </ul>		
<b>(PR)</b>	<b>#8944</b>	<b>\$3 color</b>
<p>Set the color to be shown on the top-left of screen and window title for the 3rd part system. This enables switching the color patterns for each part system.</p> <p>When set to the values "1" to "8", the part system name is shown in the form of button image.</p> <p>(Note 1) Enabled when "#8942 \$1 color" is set to the values "1" to "8".</p> <p>(Note 2) When set to "1", the color is determined by the setting of "#11060 Screen theme color".</p> <ul style="list-style-type: none"> <li>1: Theme color (default)</li> <li>2: Pink</li> <li>3: Light blue</li> <li>4: Orange</li> <li>5: Green</li> <li>6: Fuchsia</li> <li>7: YellowGreen</li> <li>8: Brown</li> </ul>		
<b>(PR)</b>	<b>#8945</b>	<b>\$4 color</b>
<p>Set the color to be shown on the top-left of screen and window title for the 4th part system. This enables switching the color patterns for each part system.</p> <p>When set to the values "1" to "8", the part system name is shown in the form of button image.</p> <p>(Note 1) Enabled when "#8942 \$1 color" is set to the values "1" to "8".</p> <p>(Note 2) When set to "1", the color is determined by the setting of "#11060 Screen theme color".</p> <ul style="list-style-type: none"> <li>1: Theme color (default)</li> <li>2: Pink</li> <li>3: Light blue</li> <li>4: Orange</li> <li>5: Green</li> <li>6: Fuchsia</li> <li>7: YellowGreen</li> <li>8: Brown</li> </ul>		
<b>#8952</b>		<b>Edit-win \$ switch</b>
<p>Select whether to enable switching of program displayed in the edit window on Monitor screen according to the displayed part system when part system switch is performed.</p> <ul style="list-style-type: none"> <li>0: Not switch</li> <li>1: Switch</li> </ul>		

<b>(PR)</b>	<b>#8953</b>	<b>2\$ disp switch typ</b>
		Select how to switch the part system to display when the 2-, 3- or 4-part system simultaneous display is enabled. 0, 1: The No. of part system to display is incremented by one. The operation target is switched when the part system displayed in the non-active area is selected. 2: The operation target on the left side is fixed to \$1. When \$1 is selected for the part system switch, the left side is the operation target. When \$2 or after is selected, the displayed part system on the right side is incremented by one. (Note) 3- or 4-part system simultaneous display is not available.
	<b>#8954</b>	<b>Initial type</b>
		Not used.
	<b>#8955</b>	<b>Init axis pair</b>
		Not used.
<b>(PR)</b>	<b>#8956</b>	<b>User key type</b>
		Not used.
<b>(PR)</b>	<b>#8957</b>	<b>T meas (L)-Simple</b>
		Select the operation mode of the manual tool length measurement 1 for L system. 0: Normal operation mode (Conventional specification) Select an axis to measure using the cursor position. 1: Simple operation mode Select an axis to measure using an axis address key or menu. More than one axis can be selected.
	<b>#8958</b>	<b>SP on 5th part sys</b>
		Select which spindle to display in the 5th part system window for the 2-, 3- or 4-part system simultaneous display. (Note 1) If you select "00" for the 2-, 3- or 4-part system simultaneous display, the default display is used (1st spindle on the upper side and 2nd spindle on the lower side). (Note 2) If you set the same number as, or a greater number than the setting of "#1039 spinno", or if the high- or low-order setting is "0", the 1st spindle is displayed. (Note 3) If you set the low-order to F, the screen shows the actual rotation speed, command speed and load meter of the high-order spindle. Note that for the 4-counter display in 4-part system simultaneous display, even if the low-order is not F, the screen shows the actual rotation speed, command speed and load meter of the high-order and low-order spindles. (Note 4) 3- or 4-part system simultaneous display is not available. <b>---Setting range---</b> High-order (Select an upper side spindle.) : 0 to 8 Low-order (Select a lower side spindle.) : 0 to 8, F
	<b>#8959</b>	<b>SP on 6th part sys</b>
		Select which spindle to display in the 6th part system window for the 2-, 3- or 4-part system simultaneous display. (Note 1) If you select "00" for the 2-, 3- or 4-part system simultaneous display, the default display is used (1st spindle on the upper side and 2nd spindle on the lower side). (Note 2) If you set the same number as, or a greater number than the setting of "#1039 spinno", or if the high- or low-order setting is "0", the 1st spindle is displayed. (Note 3) If you set the low-order to F, the screen shows the actual rotation speed, command speed and load meter of the high-order spindle. Note that for the 4-counter display in 4-part system simultaneous display, even if the low-order is not F, the screen shows the actual rotation speed, command speed and load meter of the high-order and low-order spindles. (Note 4) 3- or 4-part system simultaneous display is not available. <b>---Setting range---</b> High-order (Select an upper side spindle.) : 0 to 8 Low-order (Select a lower side spindle.) : 0 to 8, F

#8960	<b>SP on 7th part sys</b>
<p>Select which spindle to display in the 7th part system window for the 2-, 3- or 4-part system simultaneous display.</p> <p>(Note 1) If you select "00" for the 2-, 3- or 4-part system simultaneous display, the default display is used (1st spindle on the upper side and 2nd spindle on the lower side).</p> <p>(Note 2) If you set the same number as, or a greater number than the setting of "#1039 spinno", or if the high- or low-order setting is "0", the 1st spindle is displayed.</p> <p>(Note 3) If you set the low-order to F, the screen shows the actual rotation speed, command speed and load meter of the high-order spindle. Note that for the 4-counter display in 4-part system simultaneous display, even if the low-order is not F, the screen shows the actual rotation speed, command speed and load meter of the high-order and low-order spindles.</p> <p>(Note 4) 3- or 4-part system simultaneous display is not available.</p>	
---Setting range---	
High-order (Select an upper side spindle.) : 0 to 8	
Low-order (Select a lower side spindle.) : 0 to 8, F	
#8961	<b>SP on 8th part sys</b>
Not used.	
(PR)	#8962 <b>\$5 color</b>
<p>Set the color to be shown on the top-left of screen and window title for the 5th part system. This enables switching the color patterns for each part system.</p> <p>When set to the values "1" to "8", the part system name is shown in the form of button image.</p> <p>(Note 1) Enabled when "#8942 \$1 color" is set to the values "1" to "8".</p> <p>(Note 2) When set to "1", the color is determined by the setting of "#11060 Screen theme color".</p>	
---Setting range---	
<p>1: Theme color (default)</p> <p>2: Pink</p> <p>3: Light blue</p> <p>4: Orange</p> <p>5: Green</p> <p>6: Fuchsia</p> <p>7: YellowGreen</p> <p>8: Brown</p>	
(PR)	#8963 <b>\$6 color</b>
<p>Set the color to be shown on the top-left of screen and window title for the 6th part system. This enables switching the color patterns for each part system.</p> <p>When set to the values "1" to "8", the part system name is shown in the form of button image.</p> <p>(Note 1) Enabled when "#8942 \$1 color" is set to the values "1" to "8".</p> <p>(Note 2) When set to "1", the color is determined by the setting of "#11060 Screen theme color".</p>	
---Setting range---	
<p>1: Theme color (default)</p> <p>2: Pink</p> <p>3: Light blue</p> <p>4: Orange</p> <p>5: Green</p> <p>6: Fuchsia</p> <p>7: YellowGreen</p> <p>8: Brown</p>	

<b>(PR)</b>	<b>#8964</b>	<b>\$7 color</b>
		<p>Set the color to be shown on the top-left of screen and window title for the 7th part system. This enables switching the color patterns for each part system.</p> <p>When set to the values "1" to "8", the part system name is shown in the form of button image.</p> <p>(Note 1) Enabled when "#8942 \$1 color" is set to the values "1" to "8".</p> <p>(Note 2) When set to "1", the color is determined by the setting of "#11060 Screen theme color".</p> <p><b>---Setting range---</b></p> <ul style="list-style-type: none"> <li>1: Theme color (default)</li> <li>2: Pink</li> <li>3: Light blue</li> <li>4: Orange</li> <li>5: Green</li> <li>6: Fuchsia</li> <li>7: YellowGreen</li> <li>8: Brown</li> </ul>
<b>(PR)</b>	<b>#8965</b>	<b>\$8 color</b>
		Not used.
<b>(PR)</b>	<b>#8966</b>	<b>Edit: INS or OVR</b>
		<p>Select whether to insert or overwrite during edit. Insert or overwrite mode can also be changed temporarily using the INS key.</p> <ul style="list-style-type: none"> <li>0: Overwrite mode</li> <li>1: Insert mode</li> </ul>
<b>(PR)</b>	<b>#8967</b>	<b>Delete key action</b>
		<p>Select the [DELETE] key operation during edit.</p> <ul style="list-style-type: none"> <li>0: The key serves as a Delete key. (erases the character after the cursor)</li> <li>1: The key serves as a Back Space key. (erases the character before the cursor)</li> </ul>
	<b>#8968</b>	<b>Tool shape radius</b>
		<p>Tool shape radius designation</p> <p>Select the tool shape designation method.</p> <ul style="list-style-type: none"> <li>0: Diameter designation</li> <li>1: Radius designation</li> </ul>



**#8969      Tool offset type 1**

Specify the display item for the 1st column (type) and 2nd column (compensation amount) on the right side of the tool management screen list display.

The setting value and display item are specified as follows.

(Setting value): (1st column) / (2nd column)

· Tool compensation type I

0-11: H (Compensation No.) / Length compensation

· Tool compensation type II

0, 5-11: H (Compensation No.) / Length compensation

1: H (Compensation No.) / Length compensation

2: D (Compensation No.) / Radius compensation

3: +H (Compensation No.) / Length wear

4: +D (Compensation No.) / Radius wear

· Tool compensation type III

0: (Axis name (1st axis))(Compensation No.) / 1st axis tool length

1: (Axis name (1st axis))(Compensation No.) / 1st axis tool length

2: (Axis name (2nd axis))(Compensation No.) / 2nd axis tool length

3: (Axis name (Additional axis))(Compensation No.) / Additional axis tool length

4: +(Axis name (1st axis))(Compensation No.) / 1st axis wear

5: +(Axis name (2nd axis))(Compensation No.) / 2nd axis wear

6: +(Axis name (Additional axis))(Compensation No.) / Additional axis wear

7: R / Nose R

8: +R / R wear

9: P / Point

10: (Axis name (2nd additional axis))(Compensation No.) / 2nd additional axis tool length

11: +(Axis name (2nd additional axis))(Compensation No.) / 2nd additional axis wear

**---Setting range---**

0 to 11

<b>#8970</b>	<b>Tool offset type 2</b>
<p>Specify the display item for the 3rd column (type) and 4th column (compensation amount) on the right side of the tool management screen list display.</p> <p>The setting value and display item are specified as follows.</p> <p>(Setting value): (3rd column) / (4th column)</p> <ul style="list-style-type: none"> <li>· Tool compensation type I</li> <li>0-11: Set to blank / Set to blank</li> <li>· Tool compensation type II</li> <li>0, 5-11: D (Compensation No.) / Radius compensation</li> <li>1: H (Compensation No.) / Length compensation</li> <li>2: D (Compensation No.) / Radius compensation</li> <li>3: +H (Compensation No.) / Length wear</li> <li>4: +D (Compensation No.) / Radius wear</li> <li>· Tool compensation type III</li> <li>0: (Axis name (2nd axis))(Compensation No.) / 2nd axis tool length</li> <li>1: (Axis name (1st axis))(Compensation No.) / 1st axis tool length</li> <li>2: (Axis name (2nd axis))(Compensation No.) / 2nd axis tool length</li> <li>3: (Axis name (Additional axis))(Compensation No.) / Additional axis tool length</li> <li>4: +(Axis name (1st axis))(Compensation No.) / 1st axis wear</li> <li>5: +(Axis name (2nd axis))(Compensation No.) / 2nd axis wear</li> <li>6: +(Axis name (Additional axis))(Compensation No.) / Additional axis wear</li> <li>7: R / Nose R</li> <li>8: +R / R wear</li> <li>9: P / Point</li> <li>10: (Axis name (2nd additional axis))(Compensation No.) / 2nd additional axis tool length</li> <li>11: +(Axis name (2nd additional axis))(Compensation No.) / 2nd additional axis wear</li> </ul> <p>---Setting range---</p> <p>0 to 11</p>	
<b>#8971</b>	<b>Alarm window ON</b>
<p>Select whether to enable the alarm display window.</p> <p>0: Disable the alarm display window</p> <p>1: Enable the alarm display window</p>	
<b>#8972</b>	<b>T code offset disp</b>
<p>For L system only</p> <p>Select whether to display tool offset data with the address T's offset No. at the head when the tool offset screen is opened after a manual value command.</p> <p>&lt;Monitor screen&gt;</p> <p>* Open the tool offset screen (window)</p> <p>&lt;Setup screen&gt;</p> <p>* Display the tool offset screen</p> <p>(Note) The display is unchanged if you change a tool offset No. with the tool offset screen displayed.</p> <p>0: Not display tool offset data with the address T's offset No. at the head</p> <p>1: Display tool offset data with the address T's offset No. at the head</p>	
<b>(PR) #8973</b>	<b>Selective display</b>
<p>Select whether to enable selective display on an 8.4- or 10.4-type display terminal.</p> <p>0: Disable selective display</p> <p>1: Enable selective display. Select what to display using the parameter "#8940 Set select display".</p>	

	<b>#8974</b>	<b>Simple PLC switch</b>
		Not used.
	<b>#8975</b>	<b>No. search process</b>
		Select how the [XXX No search] menu works on screens including the parameter and tool offset screens. 0: When you press [No search], enter the No. to display and then press [INPUT], the data on the display is ordered to start from the designated No. 1: When you enter the No. to display and then press [No. search], the data on the display is ordered to start from the designated No.
	<b>#8976</b>	<b>Menu animation OFF</b>
		Not used.
	<b>#8977</b>	<b>Multi-\$ simul edit</b>
		Select whether to open the same named programs of different part systems simultaneously for each editing area upon a press of Open on Edit screen while Multi-part system program management is enabled. 0: Disable (Not open the programs simultaneously for each editing area) 1: Enable (Open the programs simultaneously for each editing area)
	<b>#8979</b>	<b>Touch op noise res</b>
		Not used.
	<b>#8980</b>	<b>R-Navi graphic dir</b>
		Not used.
	<b>#8981</b>	<b>NCmemory date disp</b>
		Not used.
<b>(PR)</b>	<b>#8990</b>	<b>Edit-up/down keys</b>
		Not used.
	<b>#8991</b>	<b>Interactive cycle</b>
		Not used.
<b>(PR)</b>	<b>#8992</b>	<b>Cycle switch</b>
		Not used.
	<b>#8993</b>	<b>Cycle highlight</b>
		Not used.
	<b>#8994</b>	<b>=InputOFF:Interact</b>
		Not used.
	<b>#8995</b>	<b>Touchop longtaptim</b>
		Not used.
<b>(PR)</b>	<b>#8996</b>	<b>Simple program ON</b>
		Not used.
	<b>#8998</b>	<b>Finish shape view</b>
		Not used.

## 15.11 Machining Condition Selection Parameters

(Note) The machining condition parameter groups which can be set through the machining condition setting screen are stored according to the application. The guidance display and parameter input/output on the screen follow the machining condition parameter numbers in the following table. These parameters can only be set through the machining condition setting screen.

Nos. on the machining condition setting screen	Machining Condition Parameters (Application 1)	Machining Condition Parameters (Application 2)	Machining Condition Parameters (Application 3)
#1207	#42001	#42301	#42601
#1568	#42002	#42302	#42602
#1570	#42003	#42303	#42603
#2010	#42007	#42307	#42607
#8019	#42004	#42304	#42604
#8020	#42008	#42308	#42608
#8022	#42005	#42305	#42605
#8023	#42006	#42306	#42606
#8026	#42009	#42309	#42609
#8027	#42010	#42310	#42610
#8028	#42011	#42311	#42611
#8030	#42012	#42312	#42612
#8033	#42013	#42313	#42613
#8029	#42014	#42314	#42614
#8037	#42015	#42315	#42615
#8090	#42016	#42316	#42616
#8091	#42017	#42317	#42617
#8093	#42018	#42318	#42618
#2659	#42019	#42319	#42619

#1207

G1btL

Time constant

Set a cutting feed time constant when applying pre-interpolation acceleration/deceleration.

When set to "0", the time constant will be clamped at 1ms.

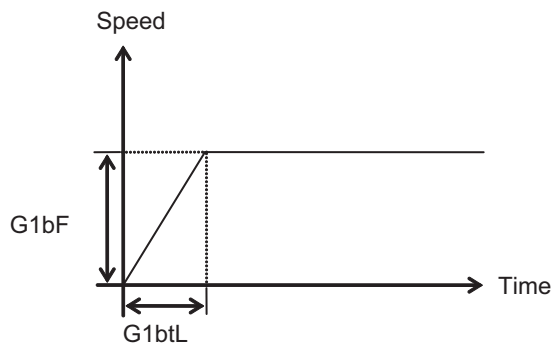

---Setting range---

Without high-accuracy control time constant expansion: 1 to 5000 (ms)

With high-accuracy control time constant expansion: 1 to 30000 (ms)

**Cutting feed Acc**    **Cutting feed acceleration**

Displays cutting feed acceleration.

#1568	SfiltG1	G01 soft acceleration/deceleration filter
		<p>Set the filter time constant for smoothly changing the acceleration rate for the cutting feed acceleration/deceleration in pre-interpolation acceleration/deceleration.</p> <p>- Notch frequency Hz Displays the notch frequency (Hz) for the S-pattern filter set in "#1568 SfiltG1" (G01 soft acceleration/deceleration filter).</p> <p>---Setting range--- 0 to 200 (ms)</p>
#1570	Sfilt2	Soft acceleration/deceleration filter 2
		<p>Set the filter time constant for smoothly changing the acceleration rate in pre-interpolation acceleration/deceleration.</p> <p>This will be disabled when "0" or "1" is set.</p> <p>- Notch frequency Hz Displays the notch frequency (Hz) for the S-shape filter set in "#1570 Sfilt2" (Soft acceleration/deceleration filter 2).</p> <p>---Setting range--- 0 to 200 (ms)</p>
#2010	fwd_g	Feed forward gain
		<p>Set a feed forward gain for pre-interpolation acceleration/deceleration.</p> <p>The larger the set value, the smaller the theoretical control error will be. However, if a machine vibration occurs, set the smaller value.</p> <p>---Setting range--- 0 to 200 (%)</p>
#2659	tolerance	Tolerance
		<p>Specify a tolerance (tolerable error) to be used under tolerance control.</p> <p>Set a tolerable error for fine segment program created by CAM. (Usually around 0.01(mm)) If 0.000 is set, it is operated with the tolerance of 0.01(mm). When designating the tolerance amount with the ", K address", this parameter is not used.</p> <p>---Setting range--- 0.000 to 100.000 (mm)</p>

**#8019 R COMP**

Set a compensation coefficient for reducing a control error in the reduction of a corner roundness and arc radius.

The larger the set value is, the smaller the theoretical error will be. However, since the speed at the corner goes down, the cycle time will be extended.

Coefficient = 100 - setting value

(Note) This function will be enabled when "#8021 COMP\_CHANGE" is set to "0".

**---Setting range---**

0 to 99 (%)

**Theoretical radius decrease error amount**

Displays the theoretical radius decrease error amount,  $\Delta R$ (mm), from the automatic calculation by NC.

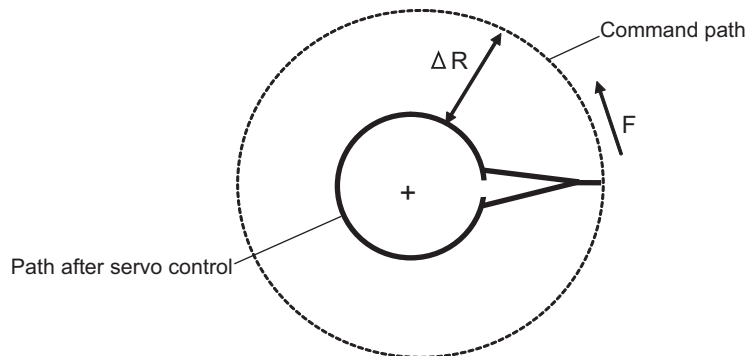

Theoretical radius decrease amount in arc

**R5mm arc deceleration speed**

Displays a deceleration speed (mm/min) along an arc of 5 (mm) radius.

**R1mm arc deceleration speed**

Displays a deceleration speed (mm/min) along an arc of 1 (mm) radius.

**#8020 DCC ANGLE**

Set the minimum value of an angle (external angle) that should be assumed to be a corner.

When an inter-block angle (external angle) in high-accuracy mode is larger than the set value, it will be determined as a corner and the speed will go down to sharpen the edge.

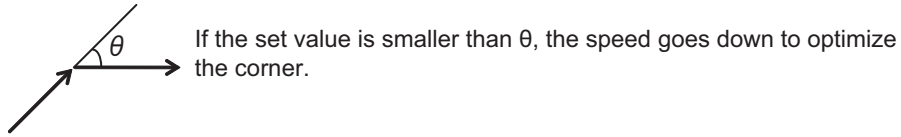

(Note) If "0" is set, it will be handled as "5" degrees.

**---Setting range---**

0 to 89 (°)

0: 5 degree (Equals to setting "5")

**Theoretical corner dull amount**

Displays the corner dull amount  $\Delta c$ (mm) in respect to the corner's angle (external angle)  $\theta$ (°).

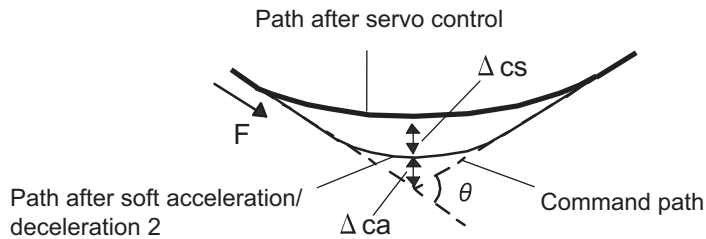

Theoretical roundness amount at corner

ca(mm): Error ( $\Delta$ ) caused by the soft acceleration/deceleration 2

cs(mm): Error ( $\Delta$ ) caused by the servo system

**Corner deceleration speed**

Display corner deceleration speed c (mm/min) for the corner of the angle (external angle) with  $\theta$ (°).

**Theoretical dull amount at 90 degree**

Display corner dull amount when the angle is 90 degree.

**Corner deceleration speed at 90 degree**

Display corner deceleration speed when the angle is 90 degree.

**#8021 COMP\_CHANGE**

Select whether to share or separate the compensation coefficient at the corner/curve during the high-accuracy control mode.

0: Share ("#8019 R COMP" is applied.)

1: Separate

\* Corner: #8022 CORNER COMP

\* Curve: #8023 CURVE COMP

(Note) Set "1" when using SSS/EasySSS control.

<b>#8022</b>	<b>CORNER COMP</b>
<p>Set the compensation coefficient to further reduce or increase the roundness at the corner during the high-accuracy control mode.</p> <p>Coefficient = 100 - setting value</p> <p>(Note) This is valid when "#8021 COMP CHANGE" is set to "1".</p> <p>Reference to "#8020 Corner decreasing speed" for theoretical corner roundness amount, corner decreasing speed, theoretical 90 degree dull amount, 90 degree corner decreasing speed.</p> <p><b>---Setting range---</b></p> <p>-1000 to 99 (%)</p>	
<b>#8023</b>	<b>CURVE COMP</b>
<p>Set the compensation coefficient to further reduce or increase the radius reduction amount at the curve (arc, involute, spline) during the high-accuracy control mode.</p> <p>Coefficient = 100 - setting value</p> <p>(Note) This is valid when "#8021 COMP CHANGE" is set to "1".</p> <p>For theoretical radius reduction error amount, R5mm arc deceleration speed and R1mm arc deceleration speed, refer to "#8019 R COMP".</p> <p><b>---Setting range---</b></p> <p>-1000 to 99 (%)</p>	
<b>#8025</b>	<b>SPLINE ON</b>
<p>For M system only.</p> <p>Specify whether to enable the fine spline function.</p> <p>0: Disable the fine spline function.</p> <p>1: Enable the fine spline function.</p> <p>Spline interpolation will be valid during G61.2 modal regardless of this setting.</p>	
<b>#8026</b>	<b>CANCEL ANG. (for M system only)</b>
<p>Set the angle where the spline interpolation is temporarily canceled.</p> <p>When the angle made by blocks exceeds this parameter setting value, spline interpolation will be canceled temporarily. In consideration of the pick feed, set a value a little smaller than the pick feed angle.</p> <p><b>---Setting range---</b></p> <p>0 to 180 (°)</p> <p>0: 180 (°)</p>	
<b>#8027</b>	<b>Toler-1 (for M system only)</b>
<p>Set the maximum chord error (tolerance) in a block that includes an inflection point. Set the tolerance applicable when the applicable block is developed to fine segments by CAM. (normally about 10 μm)</p> <p>When "0.000" is set, the applicable block will be linear.</p> <p><b>---Setting range---</b></p> <p>0.000 to 100.000 (mm)</p>	
<b>#8028</b>	<b>Toler-2 (for M system only)</b>
<p>Set the maximum chord error (tolerance) in a block that includes no inflection point. Set the tolerance applicable when the applicable block is developed to fine segments by CAM. (normally about 10 μm)</p> <p>When "0.000" is set, the applicable block will be linear.</p> <p><b>---Setting range---</b></p> <p>0.000 to 100.000 (mm)</p>	
<b>#8029</b>	<b>FairingL (for M system only)</b>
<p>Set the length of the block subject to fairing.</p> <p>(Enabled when "#8033 Fairing ON" is set to "1".)</p> <p><b>---Setting range---</b></p> <p>0 to 100.000 (mm)</p>	



<b>#8030</b>	<b>MINUTE LENG</b> (for M system only)
<p>Set the fine-segment length where the spline interpolation is temporarily canceled.</p> <p>When the length of one block exceeds this parameter setting value, spline interpolation is canceled temporarily and linear interpolation is performed. Set a value a little smaller than one block length of the program.</p> <p>If "-1" is set, spline interpolation will be performed regardless of block length.</p> <p>---Setting range---</p> <p>-1 to 127 (mm)</p> <p>0: 1 (mm)</p>	
<b>#8033</b>	<b>Fairing ON</b> (for M system only)
<p>Select whether or not to use the fairing or smooth fairing function.</p> <p>0: Use neither of them</p> <p>1: Use the fairing function</p> <p>2: Use the smooth fairing function</p>	
<b>#8037</b>	<b>CorJudgeL</b> (for M system only)
<p>Set the length of the block to be excluded when deciding a corner.</p> <p>(Enabled when "#8036 CordecJudge" is set to "1".)</p> <p>---Setting range---</p> <p>0 to 99999.999 (mm)</p>	
<b>#8090</b>	<b>SSS ON</b> (for M system only)
<p>Set whether to enable the SSS control with G05 P10000.</p> <p>0: Disable</p> <p>1: Enable</p>	
<b>#8091</b>	<b>StdLength</b> (for M system only)
<p>Set the maximum value of the range for recognizing the shape.</p> <p>To eliminate the effect of steps or errors, etc., set a large value. To enable sufficient deceleration, set a small value.</p> <p>If "0.000" is set, the standard value (1.000mm) will be applied.</p> <p>---Setting range---</p> <p>0 to 100.000 (mm)</p>	
<b>#8093</b>	<b>StepLeng</b> (for M system only)
<p>Set the width of the step at which the speed is not to be decelerated. (Approximately the same as the CAM path difference [Tolerance].)</p> <p>If "0" is set, the standard value (5<math>\mu</math>m) will be applied.</p> <p>If a minus value is set, the speed will decelerate at all minute steps.</p> <p>---Setting range---</p> <p>-1.000 to 0.100 (mm)</p>	
<b>#42001</b>	<b>P1-G1btL</b> <span style="float: right;"><b>Time constant for machining condition selection I</b></span>
<p>Time constant for machining condition selection I</p> <p>Set the time constant for the machining condition selection I function. This is equivalent to the parameter "#1207 G1btL".</p> <p>---Setting range---</p> <p>Without high-accuracy control time constant expansion: 0 to 5000 (ms)</p> <p>With high-accuracy control time constant expansion: 0 to 30000 (ms)</p>	
<b>#42002</b>	<b>P1-SfiltG1</b> <span style="float: right;"><b>G01soft acceleration/deceleration filter for machining condition selection I</b></span>
<p>G01soft acceleration/deceleration filter for machining condition selection I</p> <p>Set the G01 soft acceleration/deceleration filter's time constant for the machining condition selection I function. This is equivalent to the parameter "#1568 SfiltG1".</p> <p>---Setting range---</p> <p>0 to 200 (ms)</p>	

<b>#42003</b>	<b>P1-Sfilt2</b>	<b>Soft acceleration/deceleration filter 2 for machining condition selection I</b>
<p>Soft acceleration/deceleration filter 2 for machining condition selection I Set the soft acceleration/deceleration filter 2's time constant for the machining condition selection I function. This is equivalent to the parameter "#1570 Sfilt2".</p> <p><b>---Setting range---</b> 0 to 50 (ms)</p>		
<b>#42004</b>	<b>P1-rcomp</b>	<b>Accuracy coefficient for machining condition selection I</b>
<p>Accuracy coefficient for machining condition selection I Set the accuracy coefficient for the machining condition selection I function. This is equivalent to the parameter "#8019 R COMP".</p> <p>* This setting is enabled when "#8021 COMP_CHANGE" is set to "0".</p> <p><b>---Setting range---</b> 0 to 99 (%)</p>		
<b>#42005</b>	<b>P1-cor_comp</b>	<b>Corner accuracy coefficient for machining condition selection I</b>
<p>Corner accuracy coefficient for machining condition selection I Set the corner accuracy coefficient for the machining condition selection I function. This is equivalent to the parameter "#8022 CORNER COMP".</p> <p>* This setting is enabled when "#8021 COMP_CHANGE" is set to "1".</p> <p><b>---Setting range---</b> -1000 to 99 (%)</p>		
<b>#42006</b>	<b>P1-cur_comp</b>	<b>Curve accuracy coefficient for machining condition selection I</b>
<p>Curve accuracy coefficient for machining condition selection I Set the curve accuracy coefficient for the machining condition selection I function. This is equivalent to the parameter "#8023 CURVE COMP".</p> <p>* This setting is enabled when "#8021 COMP_CHANGE" is set to "1".</p> <p><b>---Setting range---</b> -1000 to 99 (%)</p>		
<b>#42007</b>	<b>P1-fwd_g</b>	<b>Feed forward gain for machining condition selection I</b>
<p>Feed forward gain for machining condition selection I Set the feed forward gain for the machining condition selection I function. This is equivalent to the parameter "#2010 fwd_g".</p> <p><b>---Setting range---</b> 0 to 200 (%)</p>		
<b>#42008</b>	<b>P1-fcorn</b>	<b>Corner deceleration angle for machining condition selection I</b>
<p>Corner deceleration angle for machining condition selection I Set the corner deceleration angle for the machining condition selection I function. This is equivalent to the parameter "#8020 DCC ANGLE".</p> <p><b>---Setting range---</b> 0 to 89 (°)</p>		
<b>#42009</b>	<b>P1-spcanag</b>	<b>Cancel angle for machining condition selection I</b>
<p>Cancel angle for machining condition selection I Set the cancel angle for the machining condition selection I function. This is equivalent to the parameter "#8026 CANCEL ANG".</p> <p><b>---Setting range---</b> 0 to 180 (°)</p>		

<b>#42010</b>	<b>P1-distth1</b>	<b>Chord error 1 for machining condition selection I</b>
<p>Chord error 1 for machining condition selection I Set the chord error 1 for the machining condition selection I function. This is equivalent to the parameter "#8027 Toler-1".</p> <p><b>---Setting range---</b> 0.000 to 100.000 (mm)</p>		
<b>#42011</b>	<b>P1-distth2</b>	<b>Chord error 2 for machining condition selection I</b>
<p>Chord error 2 for machining condition selection I Set the chord error 2 for the machining condition selection I function. This is equivalent to the parameter "#8028 Toler-2".</p> <p><b>---Setting range---</b> 0.000 to 100.000 (mm)</p>		
<b>#42012</b>	<b>P1-minute</b>	<b>Fine segment length for machining condition selection I</b>
<p>Fine segment length for machining condition selection I Set the fine segment length for the machining condition selection I function. This is equivalent to the parameter "#8030 MINUTE LENG".</p> <p><b>---Setting range---</b> -1 to 127 (mm)</p>		
<b>#42013</b>	<b>P1-fairing</b>	<b>Fairing ON for machining condition selection I</b>
<p>Fairing ON for machining condition selection I Set whether to enable the fairing function for the machining condition selection I function. This is equivalent to the parameter "#8033 Fairing ON".</p> <p><b>---Setting range---</b> 0/1</p>		
<b>#42014</b>	<b>P1-minleng</b>	<b>Fairing L for machining condition selection I</b>
<p>Fairing L for machining condition selection I Set the fairing length for the machining condition selection I function. This is equivalent to the parameter "#8029 FairingL".</p> <p><b>---Setting range---</b> 0 to 100.000 (mm)</p>		
<b>#42015</b>	<b>P1-cordeclen</b>	<b>Corner judgment length for machining condition selection I</b>
<p>Corner judgment length for machining condition selection I Set the corner judgment length for the machining condition selection I function. This is equivalent to the parameter "#8037 CorJudgeL".</p> <p><b>---Setting range---</b> 0 to 99999.999 (mm)</p>		
<b>#42016</b>	<b>P1-sss_prcm</b>	<b>SSS/EasySSS control ON for machining condition selection I</b>
<p>SSS/EasySSS control ON for machining condition selection I Set whether to enable the SSS/EasySSS control for the machining condition selection I function. This is equivalent to the parameter "#8090 SSS ON".</p> <p><b>---Setting range---</b> 0/1</p>		
<b>#42017</b>	<b>P1-std_length</b>	<b>Standard length for machining condition selection I</b>
<p>Standard length for machining condition selection I Set the standard length for the machining condition selection I function. This is equivalent to the parameter "#8091 StdLength".</p> <p><b>---Setting range---</b> 0 to 100.000 (mm)</p>		

<b>#42018</b>	<b>P1-step_length</b>	<b>Step width for machining condition selection I</b>
Step width for machining condition selection I		
Set the width of the step for the machining condition selection I function. This is equivalent to the parameter "#8093 StepLeng".		
<b>---Setting range---</b>		
-1.000 to 0.100 (mm)		
<b>#42019</b>	<b>P1-tolerance</b>	<b>Tolerance for machining condition selection I</b>
Set the tolerance for machining condition selection parameter group for machining condition selection I function. This is equivalent to the parameter "#2659 tolerance".		
<b>---Setting range---</b>		
0 to 100.000 (mm)		
<b>#42301</b>	<b>P2-G1btL</b>	<b>Time constant for machining condition selection I</b>
Time constant for machining condition selection I		
Set the time constant for the machining condition selection I function. This is equivalent to the parameter "#1207 G1btL".		
<b>---Setting range---</b>		
Without high-accuracy control time constant expansion: 0 to 5000 (ms)		
With high-accuracy control time constant expansion: 0 to 30000 (ms)		
<b>#42302</b>	<b>P2-SfiltG1</b>	<b>G01soft acceleration/deceleration filter for machining condition selection I</b>
G01soft acceleration/deceleration filter for machining condition selection I		
Set the G01 soft acceleration/deceleration filter's time constant for the machining condition selection I function. This is equivalent to the parameter "#1568 SfiltG1".		
<b>---Setting range---</b>		
0 to 200 (ms)		
<b>#42303</b>	<b>P2-Sfilt2</b>	<b>Soft acceleration/deceleration filter 2 for machining condition selection I</b>
Soft acceleration/deceleration filter 2 for machining condition selection I		
Set the soft acceleration/deceleration filter 2's time constant for the machining condition selection I function. This is equivalent to the parameter "#1570 Sfilt2".		
<b>---Setting range---</b>		
0 to 50 (ms)		
<b>#42304</b>	<b>P2-rcomp</b>	<b>Accuracy coefficient for machining condition selection I</b>
Accuracy coefficient for machining condition selection I		
Set the accuracy coefficient for the machining condition selection I function. This is equivalent to the parameter "#8019 R COMP".		
* This setting is enabled when "#8021 COMP_CHANGE" is set to "0".		
<b>---Setting range---</b>		
0 to 99 (%)		
<b>#42305</b>	<b>P2-cor_comp</b>	<b>Corner accuracy coefficient for machining condition selection I</b>
Corner accuracy coefficient for machining condition selection I		
Set the corner accuracy coefficient for the machining condition selection I function. This is equivalent to the parameter "#8022 CORNER COMP".		
* This setting is enabled when "#8021 COMP_CHANGE" is set to "1".		
<b>---Setting range---</b>		
-1000 to 99 (%)		

<b>#42306</b>	<b>P2-cur_comp</b>	<b>Curve accuracy coefficient for machining condition selection I</b>
<p>Curve accuracy coefficient for machining condition selection I</p> <p>Set the curve accuracy coefficient for the machining condition selection I function. This is equivalent to the parameter "#8023 CURVE COMP".</p> <p>* This setting is enabled when "#8021 COMP_CHANGE" is set to "1".</p> <p><b>---Setting range---</b></p> <p>-1000 to 99 (%)</p>		
<b>#42307</b>	<b>P2-fwd_g</b>	<b>Feed forward gain for machining condition selection I</b>
<p>Feed forward gain for machining condition selection I</p> <p>Set the feed forward gain for the machining condition selection I function. This is equivalent to the parameter "#2010 fwd_g".</p> <p><b>---Setting range---</b></p> <p>0 to 200 (%)</p>		
<b>#42308</b>	<b>P2-fcorn</b>	<b>Corner deceleration angle for machining condition selection I</b>
<p>Corner deceleration angle for machining condition selection I</p> <p>Set the corner deceleration angle for the machining condition selection I function. This is equivalent to the parameter "#8020 DCC ANGLE".</p> <p><b>---Setting range---</b></p> <p>0 to 89 (°)</p>		
<b>#42309</b>	<b>P2-spcanag</b>	<b>Cancel angle for machining condition selection I</b>
<p>Cancel angle for machining condition selection I</p> <p>Set the cancel angle for the machining condition selection I function. This is equivalent to the parameter "#8026 CANCEL ANG".</p> <p><b>---Setting range---</b></p> <p>0 to 180 (°)</p>		
<b>#42310</b>	<b>P2-distth1</b>	<b>Chord error 1 for machining condition selection I</b>
<p>Chord error 1 for machining condition selection I</p> <p>Set the chord error 1 for the machining condition selection I function. This is equivalent to the parameter "#8027 Toler-1".</p> <p><b>---Setting range---</b></p> <p>0.000 to 100.000 (mm)</p>		
<b>#42311</b>	<b>P2-distth2</b>	<b>Chord error 2 for machining condition selection I</b>
<p>Chord error 2 for machining condition selection I</p> <p>Set the chord error 2 for the machining condition selection I function. This is equivalent to the parameter "#8028 Toler-2".</p> <p><b>---Setting range---</b></p> <p>0.000 to 100.000 (mm)</p>		
<b>#42312</b>	<b>P2-minute</b>	<b>Fine segment length for machining condition selection I</b>
<p>Fine segment length for machining condition selection I</p> <p>Set the fine segment length for the machining condition selection I function. This is equivalent to the parameter "#8030 MINUTE LENG".</p> <p><b>---Setting range---</b></p> <p>-1 to 127 (mm)</p>		
<b>#42313</b>	<b>P2-fairing</b>	<b>Fairing ON for machining condition selection I</b>
<p>Fairing ON for machining condition selection I</p> <p>Set whether to enable the fairing function for the machining condition selection I function. This is equivalent to the parameter "#8033 Fairing ON".</p> <p><b>---Setting range---</b></p> <p>0/1</p>		

<b>#42314</b>	<b>P2-minleng</b>	<b>Fairing L for machining condition selection I</b>
Fairing L for machining condition selection I Set the fairing length for the machining condition selection I function. This is equivalent to the parameter "#8029 FairingL".		
<b>---Setting range---</b>		
0 to 100.000 (mm)		
<b>#42315</b>	<b>P2-cordeclen</b>	<b>Corner judgment length for machining condition selection I</b>
Corner judgment length for machining condition selection I Set the corner judgment length for the machining condition selection I function. This is equivalent to the parameter "#8037 CorJudgel".		
<b>---Setting range---</b>		
0 to 99999.999 (mm)		
<b>#42316</b>	<b>P2-sss_prcm</b>	<b>SSS/EasySSS control ON for machining condition selection I</b>
SSS/EasySSS control ON for machining condition selection I Set whether to enable the SSS/EasySSS control for the machining condition selection I function. This is equivalent to the parameter "#8090 SSS ON".		
<b>---Setting range---</b>		
0/1		
<b>#42317</b>	<b>P2-std_length</b>	<b>Standard length for machining condition selection I</b>
Standard length for machining condition selection I Set the standard length for the machining condition selection I function. This is equivalent to the parameter "#8091 StdLength".		
<b>---Setting range---</b>		
0 to 100.000 (mm)		
<b>#42318</b>	<b>P2-step_length</b>	<b>Step width for machining condition selection I</b>
Step width for machining condition selection I Set the width of the step for the machining condition selection I function. This is equivalent to the parameter "#8093 StepLeng".		
<b>---Setting range---</b>		
-1.000 to 0.100 (mm)		
<b>#42319</b>	<b>P2-tolerance</b>	<b>Tolerance for machining condition selection I</b>
Set the tolerance for machining condition selection parameter group for machining condition selection I function. This is equivalent to the parameter "#2659 tolerance".		
<b>---Setting range---</b>		
0 to 100.000 (mm)		
<b>#42601</b>	<b>P3-G1btL</b>	<b>Time constant for machining condition selection I</b>
Time constant for machining condition selection I Set the time constant for the machining condition selection I function. This is equivalent to the parameter "#1207 G1btL".		
<b>---Setting range---</b>		
Without high-accuracy control time constant expansion: 0 to 5000 (ms) With high-accuracy control time constant expansion: 0 to 30000 (ms)		
<b>#42602</b>	<b>P3-SfiltG1</b>	<b>G01soft acceleration/deceleration filter for machining condition selection I</b>
G01soft acceleration/deceleration filter for machining condition selection I Set the G01 soft acceleration/deceleration filter's time constant for the machining condition selection I function. This is equivalent to the parameter "#1568 SfiltG1".		
<b>---Setting range---</b>		
0 to 200 (ms)		

<b>#42603</b>	<b>P3-Sfilt2</b>	<b>Soft acceleration/deceleration filter 2 for machining condition selection I</b>
<p>Soft acceleration/deceleration filter 2 for machining condition selection I</p> <p>Set the soft acceleration/deceleration filter 2's time constant for the machining condition selection I function. This is equivalent to the parameter "#1570 Sfilt2".</p> <p><b>---Setting range---</b></p> <p>0 to 50 (ms)</p>		
<b>#42604</b>	<b>P3-rcomp</b>	<b>Accuracy coefficient for machining condition selection I</b>
<p>Accuracy coefficient for machining condition selection I</p> <p>Set the accuracy coefficient for the machining condition selection I function. This is equivalent to the parameter "#8019 R COMP".</p> <p>* This setting is enabled when "#8021 COMP_CHANGE" is set to "0".</p> <p><b>---Setting range---</b></p> <p>0 to 99 (%)</p>		
<b>#42605</b>	<b>P3-cor_comp</b>	<b>Corner accuracy coefficient for machining condition selection I</b>
<p>Corner accuracy coefficient for machining condition selection I</p> <p>Set the corner accuracy coefficient for the machining condition selection I function. This is equivalent to the parameter "#8022 CORNER COMP".</p> <p>* This setting is enabled when "#8021 COMP_CHANGE" is set to "1".</p> <p><b>---Setting range---</b></p> <p>-1000 to 99 (%)</p>		
<b>#42606</b>	<b>P3-cur_comp</b>	<b>Curve accuracy coefficient for machining condition selection I</b>
<p>Curve accuracy coefficient for machining condition selection I</p> <p>Set the curve accuracy coefficient for the machining condition selection I function. This is equivalent to the parameter "#8023 CURVE COMP".</p> <p>* This setting is enabled when "#8021 COMP_CHANGE" is set to "1".</p> <p><b>---Setting range---</b></p> <p>-1000 to 99 (%)</p>		
<b>#42607</b>	<b>P3-fwd_g</b>	<b>Feed forward gain for machining condition selection I</b>
<p>Feed forward gain for machining condition selection I</p> <p>Set the feed forward gain for the machining condition selection I function. This is equivalent to the parameter "#2010 fwd_g".</p> <p><b>---Setting range---</b></p> <p>0 to 200 (%)</p>		
<b>#42608</b>	<b>P3-fcorn</b>	<b>Corner deceleration angle for machining condition selection I</b>
<p>Corner deceleration angle for machining condition selection I</p> <p>Set the corner deceleration angle for the machining condition selection I function. This is equivalent to the parameter "#8020 DCC ANGLE".</p> <p><b>---Setting range---</b></p> <p>0 to 89 (°)</p>		
<b>#42609</b>	<b>P3-spcanag</b>	<b>Cancel angle for machining condition selection I</b>
<p>Cancel angle for machining condition selection I</p> <p>Set the cancel angle for the machining condition selection I function. This is equivalent to the parameter "#8026 CANCEL ANG".</p> <p><b>---Setting range---</b></p> <p>0 to 180 (°)</p>		

<b>#42610</b>	<b>P3-distth1</b>	<b>Chord error 1 for machining condition selection I</b>
Chord error 1 for machining condition selection I		
Set the chord error 1 for the machining condition selection I function. This is equivalent to the parameter "#8027 Toler-1".		
<b>---Setting range---</b>		
0.000 to 100.000 (mm)		
<b>#42611</b>	<b>P3-distth2</b>	<b>Chord error 2 for machining condition selection I</b>
Chord error 2 for machining condition selection I		
Set the chord error 2 for the machining condition selection I function. This is equivalent to the parameter "#8028 Toler-2".		
<b>---Setting range---</b>		
0.000 to 100.000 (mm)		
<b>#42612</b>	<b>P3-minute</b>	<b>Fine segment length for machining condition selection I</b>
Fine segment length for machining condition selection I		
Set the fine segment length for the machining condition selection I function. This is equivalent to the parameter "#8030 MINUTE LENG".		
<b>---Setting range---</b>		
-1 to 127 (mm)		
<b>#42613</b>	<b>P3-fairing</b>	<b>Fairing ON for machining condition selection I</b>
Fairing ON for machining condition selection I		
Set whether to enable the fairing function for the machining condition selection I function. This is equivalent to the parameter "#8033 Fairing ON".		
<b>---Setting range---</b>		
0/1		
<b>#42614</b>	<b>P3-minleng</b>	<b>Fairing L for machining condition selection I</b>
Fairing L for machining condition selection I		
Set the fairing length for the machining condition selection I function. This is equivalent to the parameter "#8029 FairingL".		
<b>---Setting range---</b>		
0 to 100.000 (mm)		
<b>#42615</b>	<b>P3-cordeclen</b>	<b>Corner judgment length for machining condition selection I</b>
Corner judgment length for machining condition selection I		
Set the corner judgment length for the machining condition selection I function. This is equivalent to the parameter "#8037 CorJudgeL".		
<b>---Setting range---</b>		
0 to 99999.999 (mm)		
<b>#42616</b>	<b>P3-sss_prcm</b>	<b>SSS/EasySSS control ON for machining condition selection I</b>
SSS/EasySSS control ON for machining condition selection I		
Set whether to enable the SSS/EasySSS control for the machining condition selection I function. This is equivalent to the parameter "#8090 SSS ON".		
<b>---Setting range---</b>		
0/1		
<b>#42617</b>	<b>P3-std_length</b>	<b>Standard length for machining condition selection I</b>
Standard length for machining condition selection I		
Set the standard length for the machining condition selection I function. This is equivalent to the parameter "#8091 StdLength".		
<b>---Setting range---</b>		
0 to 100.000 (mm)		



#42618	P3-step_length	Step width for machining condition selection I
		Step width for machining condition selection I Set the width of the step for the machining condition selection I function. This is equivalent to the parameter "#8093 StepLeng".
		<b>---Setting range---</b> -1.000 to 0.100 (mm)
#42619	P3-tolerance	Tolerance for machining condition selection I
		Set the tolerance for machining condition selection parameter group for machining condition selection I function. This is equivalent to the parameter "#2659 tolerance".
		<b>---Setting range---</b> 0 to 100.000 (mm)

## 15.12 Menu Selection Parameters

---

(PR)	#10501- 10530	Monitr main menu 1 to 30
------	------------------	--------------------------

---

Select the menu Nos. to be displayed on Monitor screen's main menus.

Set the menu No. (numbered in the initial order) which you wish to set first from the left of Monitor's main menus in #10501, second in the next parameter and likewise afterwards.

(E.g.) When you set the parameter #10501 to 11, the menu initially displayed at the left end of Monitor main menu's 2nd page is displayed at the left end of the 1st page.

(Note) If you set the No. of menu which is not displayed in the initial state (without setting the menu selection parameters), the menu won't be displayed after this parameter setting.

-- Menu No. --

-1: Not display

0: Default

1: Search

2: Reserch

3: Edit

6: Offset

7: Coord

8: W-shift

10: Dsp sw.

11: Modal

12: Tree

13: Time

14: Com var

15: Loc var

16: P corr

18: G92 set

19: Col stp

20: LdMeter

21: Sp-stby

22: TipDisp

23: All sp

27: Next Ax

28: Cnt exp

29: Cnt set

30: MST

---

**(PR) #10551- Setup main menu 1 to 30**  
**10580**

---

Select the menu Nos. to be displayed on Setup screen's main menus.

Set the menu No. (numbered in the initial order) which you wish to set first from the left of Setup's main menus in #10551, second in the next parameter and likewise afterwards.

(E.g.) When you set the parameter #10551 to 11, the menu initially displayed at the left end of Setup main menu's 2nd page is displayed at the left end of the 1st page.

(Note) If you set the No. of menu which is not displayed in the initial state (without setting the menu selection parameters), the menu won't be displayed after this parameter setting.

-- Menu No. --

-1: Not display

0: Default

1: T-ofs

2: T-meas

3: T-reg

4: T-life

5: Coord

6: W-meas

7: T-Mng.

8: MDI

9: Cnt set

10: MST

13: User

15: Storage

17: MacCond

22: Barrier

---

**(PR) #10601- Edit main menu 1 to 30**  
**10630**

---

Select the menu Nos. to be displayed on Edit screen's main menus.

Set the menu No. (numbered in the initial order) which you wish to set first from the left of Edit's main menus in #10601, second in the next parameter and likewise afterwards.

(E.g.) When you set the parameter #10601 to 11, the menu initially displayed at the left end of Edit main menu's 2nd page is displayed at the left end of the 1st page.

(Note) If you set the No. of menu which is not displayed in the initial state (without setting the menu selection parameters), the menu won't be displayed after this parameter setting.

-- Menu No. --

-1: Not display

0: Default

1: Edit

5: I/O

## Machine Parameters

The parameters with "(PR)" requires the CNC to be turned OFF after the settings. Turn the power OFF and ON to enable the parameter settings.

## 16.1 Base System Parameters

(PR)	#1001	SYS_ON	System validation setup
<p>Select the existence of PLC axes and part systems.</p> <p>0: Not exist 1: Exist</p>			
(PR)	#1002	axisno	Number of axes
<p>Set the number of control axes and PLC axes.</p> <p>A total of 32 axes can be set.</p> <p>Control axis: 0 to 16 PLC axis: 0 to 8</p> <p>When set to "0", the number of control axes in the part system will be "0". Do not set the number of control axes of the first part system to "0".</p> <p>(Note) The setting range differs according to the model.</p>			
(PR)	#1003	iunit	Input setup unit
<p>Select the input setting value for each part system and the PLC axis.</p> <p>Increments in parameters will follow this selection.</p> <p>---Setting range---</p> <p>B: 1 <math>\mu\text{m}</math> C: 0.1 <math>\mu\text{m}</math></p>			
(PR)	#1004	ctrl_unit	Control unit
<p>Set the unit for the NC internal position data, data communicated between the NC and drive unit, and the servo movement data.</p> <p>Some parameter units, such as the pitch error and backlash, follow this specification.</p> <p>The standard value is "D"; however, set the optimum value according to the machine model and specifications.</p> <p>B: 1 <math>\mu\text{m}</math> C: 0.1 <math>\mu\text{m}</math> D: 0.01 <math>\mu\text{m}</math> (10nm) E: 0.001 <math>\mu\text{m}</math> (1nm)</p>			
(PR)	#1005	plcunit	PLC unit
<p>Select the PLC interface setting and display increment.</p> <p>The PLC interface setting and display increment will follow this specification. Note that the PLC axis will follow "#1003 iunit".</p> <p>---Setting range---</p> <p>B: 1 <math>\mu\text{m}</math> C: 0.1 <math>\mu\text{m}</math></p>			
(PR)	#1006	mcmpunit	Machine error compensation unit
<p>Select the machine error compensation setting and display increment.</p> <p>The parameters related to machine error compensation (backlash, pitch error compensation, etc.) and PLC interface (external machine coordinate system compensation) will follow this selection.</p> <p>---Setting range---</p> <p>B: 1 <math>\mu\text{m}</math> C: 0.1 <math>\mu\text{m}</math></p>			

(PR)	#1007	System type select	System type select
		Select the NC system type. 0: Machining center system (M system) 1: Lathe system (L system)	
		(Note 1) If the setting value is out of range, M system will be selected.	
	#1025	I_plane	Initial plane selection
		Select the plane to be selected when the power is turned ON or reset. When 0 is specified, 1 is assumed (X-Y plane).e model and specifications. 1: X-Y plane (G17 command state) 2: Z-X plane (G18 command state) 3: Y-Z plane (G19 command state)	
	#1026	base_I	Base axis I
		Set the names of the basic axes that compose the plane. Set the axis name set in "#1013 axname". If all three items ("base_I", "base_J" and "base_K") do not need to be set, such as for 2-axis specifications, input "0", and the parameter will be blank. Normally, when X, Y and Z are specified respectively for base_I, _J, _K, the following relation will be established: G17: X-Y G18: Z-X G19: Y-Z Or specify any other axis name desired.	
		<b>---Setting range---</b> Axis names such as X, Y or Z	
	#1027	base_J	Base axis J
		Set the names of the basic axes that compose the plane. Set the axis name set in "#1013 axname". If all three items ("base_I", "base_J" and "base_K") do not need to be set, such as for 2-axis specifications, input "0", and the parameter will be blank. Normally, when X, Y and Z are specified respectively for base_I, _J, _K, the following relation will be established: G17: X-Y G18: Z-X G19: Y-Z Or specify any other axis name desired.	
		<b>---Setting range---</b> Axis names such as X, Y or Z	
	#1028	base_K	Base axis K
		Set the names of the basic axes that compose the plane. Set the axis name set in "#1013 axname". If all three items ("base_I", "base_J" and "base_K") do not need to be set, such as for 2-axis specifications, input "0", and the parameter will be blank. Normally, when X, Y and Z are specified respectively for base_I, _J, _K, the following relation will be established: G17: X-Y G18: Z-X G19: Y-Z Or specify any other axis name desired.	
		<b>---Setting range---</b> Axis names such as X, Y or Z	

	<b>#1029</b>	<b>aux_I</b>	<b>Flat axis I</b>
		Set the axis name when there is an axis parallel to "#1026 base_I".	
		<b>---Setting range---</b>	
		Axis names such as X, Y or Z	
	<b>#1030</b>	<b>aux_J</b>	<b>Flat axis J</b>
		Set the axis name when there is an axis parallel to "#1027 base_J".	
		<b>---Setting range---</b>	
		Axis names such as X, Y or Z	
	<b>#1031</b>	<b>aux_K</b>	<b>Flat axis K</b>
		Set the axis name when there is an axis parallel to "#1028 base_K".	
		<b>---Setting range---</b>	
		Axis names such as X, Y or Z	
<b>(PR)</b>	<b>#1037</b>	<b>cmdtyp</b>	<b>Command type</b>
		Set the G code list and compensation type for programs.	
		1: List1 (for M)    Type I (one compensation amount for one compensation No.)	
		2: List1 (for M)    Type II (shape and wear compensation amounts for one comp. No.)	
		3: List2 (for L)    Type III (shape and wear compensation amounts for one comp. No.)	
		4: List3 (for L)    Ditto	
		5: List4 (for special L)    Ditto	
		6: List5 (for special L)    Ditto	
		7: List6 (for special L)    Ditto	
		8: List7 (for special L)    Ditto	
		9: List8 (for M)    M2 form at type    Type I (one compensation amount for one compensation No.)	
		10: List8 (for M)    M2 form at type    Type II (shape and wear compensation amounts for one compensation No.)	
		There are some items in the specifications that can be used or cannot be used according to the value set in this parameter.	
		The file structure may also change depending on the compensation data type.	
		(Note) When this parameter is changed, the file system will be changed after the power is turned ON. So always execute format. The new format will be enabled after turning the power ON again.	
		Setting order (1) cmdtyp changeover -> (2) Turn power ON again -> (3) Format -> (4) Turn power ON again	
		(Note) Compensation type III can be selected for M system by setting #1046.	
	<b>#1073</b>	<b>I_Absm</b>	<b>Initial absolute setting</b>
		Select the mode (absolute or incremental) at turning ON the power or reset.	
		0: Incremental setting	
		1: Absolute setting	
	<b>#1074</b>	<b>I_Sync</b>	<b>Initial synchronous feed</b>
		Select the feedrate mode at turning ON the power or reset.	
		0: Asynchronous feed (feed per minute)	
		1: Synchronous feed (feed per revolution)	
	<b>#1075</b>	<b>I_G00</b>	<b>Initial G00</b>
		Select the linear command mode at turning ON the power or reset.	
		0: Linear interpolation (G01 command state)	
		1: Positioning (G00 command state)	

#1076	Absinc	ABS/INC address (for L system only)
		<p>Select the command method for the absolute and incremental commands. The absolute command/incremental command can be issued by using the absolute command address and incremental command address for the same axis.</p> <p>0: Use G command for the absolute and incremental commands. 1: Use axis name for the absolute and incremental commands. (The axis name in "#1013 axname" will be the absolute command, "#1014 incax" will be the incremental command.)</p>
#1085	G00Drn	G00 dry run
		<p>Select whether to apply dry run (feed at manual setting speed instead of command feedrate) to the G00 command.</p> <p>0: Not apply to G00. (move at rapid traverse rate) 1: Apply to G00. (move at manual setting speed)</p>
#1086	G0Intp	G00 non-interpolation
		<p>Select the G00 travel path type.</p> <p>0: Move linearly toward the end point. (interpolation type) 1: Move to the end point of each axis at the rapid traverse feedrate for each axis. (non-interpolation)</p> <p>(Note) If this parameter is set to "1", neither of the following functions will be available: rapid traverse constant-gradient acceleration/deceleration and rapid traverse constant-gradient multi-step acceleration/deceleration.</p>
#1109	subs_M	Validate substitute M code
		<p>Select the user macro interrupt with the substitute M code.</p> <p>0: Disable substitute M code 1: Enable substitute M code</p>
#1110	M96_M	M96 substitute M code
		<p>Set an M code to replace M96 when "#1109 subs_M" is set to "1".</p> <p>---Setting range---</p> <p>3 to 97 (excluding 30)</p>
#1111	M97_M	M97 substitute M code
		<p>Specify an M code to replace M97 when "#1109 subs_M" is set to "1".</p> <p>---Setting range---</p> <p>3 to 97 (excluding 30)</p>
#1148	I_G611	Initial hi-precis
		<p>Select the modal state at power ON from among the following: high-accuracy control mode, high-speed high-accuracy control I mode, high-speed high-accuracy control II mode or high-speed high-accuracy control III mode.</p> <p>0: G08P0/G64 (cutting) mode 1: G08P1/G61.1 (high-accuracy control) mode 2: G05.1Q1 (high-speed high-accuracy control I) mode 3: G05P10000 (high-speed high-accuracy control II) mode 4: G05P20000 (high-speed high-accuracy control III) mode</p>
#1151	rstint	Reset initial
		<p>Select whether to initialize (power ON state) the modals by resetting.</p> <p>0: Not initialize modal state 1: Initialize modal state</p>



<b>#1169</b>	<b>part system name</b>	<b>Part system name</b>
	Set the name of each part system. This must be set only when using multi-part system. This name will be displayed on the screen only when the part systems must be identified. Use 4 or less characters consisting of both alphabets and numbers.	
	<b>---Setting range---</b> 4 or less characters consisting of both alphabets and numbers	
<b>#1170</b>	<b>M2name</b>	<b>Second miscellaneous code</b>
	Set this address code when using the 2nd miscellaneous command. Set an address with A, B or C that is not used for "#1013 axname" or "#1014 incax".	
	<b>---Setting range---</b> A, B, C	
<b>#1171</b>	<b>taprov</b>	<b>Tap return override</b>
	Set the tap return override value for the synchronous tapping. When "0" is set, it will be regarded as 100%.	
	<b>---Setting range---</b> 0 to 100 (%)	
<b>#1172</b>	<b>tapovr</b>	<b>Tap return override</b>
	Set the override value applied during a retract operation in synchronous tapping. When set to "0", 100% is applied.	
	<b>---Setting range---</b> 0 to 999 (%)	
<b>#1173</b>	<b>dwlskp</b>	<b>G04 skip condition</b>
	Set the skip signal for ending the G04 (dwell) command. PLC interface input signal Skip3 Skip2 Skip1	
	0: - - -	
	1: - - *	
	2: - * -	
	3: - * *	
	4: * - -	
	5: * - *	
	6: * * -	
	7: * * *	
	(*: Enable, -: Disable)	
<b>#1174</b>	<b>skip_F</b>	<b>G31 skip speed</b>
	Set the feedrate when there is no F command in the program at G31 (skip) command.	
	<b>---Setting range---</b> 1 to 999999 (mm/min)	
<b>#1175</b>	<b>skip1</b>	<b>G31.1 skip condition</b>
	Designate the skip signal in multi-step skip G31.1. The setting method is same as "#1173 dwlskp".	
<b>#1176</b>	<b>skip1f</b>	<b>G31.1 skip speed</b>
	Set the skip feedrate in multi-step skip G31.1.	
	<b>---Setting range---</b> 1 to 999999 (mm/min)	
<b>#1177</b>	<b>skip2</b>	<b>G31.2 skip condition</b>
	Set the skip signal in multi-step skip G31.2. The setting method is same as "#1173 dwlskp".	

<b>#1178</b>	<b>skip2f</b>	<b>G31.2 skip speed</b>
Set the skip feedrate in multi-step skip G31.2.		
<b>---Setting range---</b>		
1 to 999999 (mm/min)		
<b>#1179</b>	<b>skip3</b>	<b>G31.3 skip condition</b>
Set the skip signal in multi-step skip G31.3.		
The setting method is same as "#1173 dwlskp".		
<b>#1180</b>	<b>skip3f</b>	<b>G31.3 skip speed</b>
Set the skip feedrate in multi-step skip G31.3.		
<b>---Setting range---</b>		
1 to 999999 (mm/min)		
<b>#1181</b>	<b>G96_ax</b>	<b>Constant surface speed axis</b>
Select the axis to be targeted for constant surface speed control.		
0: Program setting will be disabled, and the axis will always be fixed to the 1st axis		
1: 1st axis		
2: 2nd axis		
3: 3rd axis		
:		
16: 16th axis		
However, when set to other than "0", the priority will be on the program setting.		
<b>#1182</b>	<b>thr_F</b>	<b>Thread cutting speed</b>
Set the retract speed when not using chamfering in the thread cutting cycle.		
0: Cutting feed clamp feedrate		
1 to 60000 mm/min: Setting feedrate		
<b>---Setting range---</b>		
0 to 60000 (mm/min)		
<b>#1183</b>	<b>clmp_M</b>	<b>M code for clamp</b>
Set the M code for C axis clamp in hole drilling cycle.		
<b>---Setting range---</b>		
0 to 99999999		
<b>#1184</b>	<b>clmp_D</b>	<b>Dwelling time after outputting M code for unclamp</b>
Set the dwell time after outputting the M code for C axis unclamp in hole drilling cycle.		
<b>---Setting range---</b>		
0.000 to 99999.999 (s)		
<b>#1185</b>	<b>spd_F1</b>	<b>F1 digit feedrate F1</b>
Set the feedrate for the F command in the F 1-digit command ("#1079 F1digit" is set to "1").		
Feedrate when F1 is issued (mm/min).		
When "#1246 set08/bit6" is set to "1" and F 1-digit feed is commanded, the feedrate can be increased/decreased by operating the manual handle.		
<b>---Setting range---</b>		
0 to 1000000 (mm/min)		
<b>#1186</b>	<b>spd_F2</b>	<b>F1 digit feedrate F2</b>
Set the feedrate for the F command in the F 1-digit command ("#1079 F1digit" is set to "1").		
Feedrate when F2 is issued (mm/min).		
When "#1246 set08/bit6" is set to "1" and F 1-digit feed is commanded, the feedrate can be increased/decreased by operating the manual handle.		
<b>---Setting range---</b>		
0 to 1000000 (mm/min)		

	<b>#1187</b>	<b>spd_F3</b>	<b>F1 digit feedrate F3</b>
			<p>Set the feedrate for the F command in the F 1-digit command ("#1079 F1digit" is set to "1").</p> <p>Feedrate when F3 is issued (mm/min).</p> <p>When "#1246 set08/bit6" is set to "1" and F 1-digit feed is commanded, the feedrate can be increased/decreased by operating the manual handle.</p> <p><b>---Setting range---</b></p> <p>0 to 1000000 (mm/min)</p>
	<b>#1188</b>	<b>spd_F4</b>	<b>F1 digit feedrate F4</b>
			<p>Set the feedrate for the F command in the F 1-digit command ("#1079 F1digit" is set to "1").</p> <p>Feedrate when F4 is issued (mm/min).</p> <p>When "#1246 set08/bit6" is set to "1" and F 1-digit feed is commanded, the feedrate can be increased/decreased by operating the manual handle.</p> <p><b>---Setting range---</b></p> <p>0 to 1000000 (mm/min)</p>
	<b>#1189</b>	<b>spd_F5</b>	<b>F1 digit feedrate F5</b>
			<p>Set the feedrate for the F command in the F 1-digit command ("#1079 F1digit" is set to "1").</p> <p>Feedrate when F5 is issued (mm/min).</p> <p>When "#1246 set08/bit6" is set to "1" and F 1-digit feed is commanded, the feedrate can be increased/decreased by operating the manual handle.</p> <p><b>---Setting range---</b></p> <p>0 to 1000000 (mm/min)</p>
<b>(PR)</b>	<b>#1190</b>	<b>s_xcnt</b>	<b>Validate inclined axis control (for L system only)</b>
			<p>Select whether to enable or disable inclined axis control.</p> <p>0: Disable inclined axis control</p> <p>1: Enable inclined axis control</p>
<b>(PR)</b>	<b>#1191</b>	<b>s_angl</b>	<b>Inclination angle (for L system only)</b>
			<p>Set the inclination angle (<math>\theta</math>).</p> <p>(Note) When set to "0", the angle determined by three-side setting will be applied.</p> <p><b>---Setting range---</b></p> <p>-80.000 to 80.000 (<math>^{\circ}</math>)</p>
<b>(PR)</b>	<b>#1192</b>	<b>s_zrmv</b>	<b>Compensation at reference position return (for L system only)</b>
			<p>Select whether to perform compensation for the basic axis corresponding to the inclined axis at reference position return.</p> <p>0: Perform compensation</p> <p>1: Not perform compensation</p>
	<b>#1193</b>	<b>inpos</b>	<b>Deceleration check method 1</b>
			<p>The setting is selected with the parameter "#1306 InpsTyp".</p> <p>0: Deceleration check method 1</p> <p>Select the deceleration check method for G0.</p> <p>0: Command deceleration check</p> <p>1: In-position check</p> <p>2: Smoothing check</p> <p>1: Validate in-position check</p> <p>Specify the deceleration confirmation method for the positioning or cutting command.</p> <p>0: G0, G1+G9 Command deceleration check</p> <p>1: G0, G1+G9 In-position check</p> <p>2: G0, G1+G9 Smoothing check</p>

	<b>#1194</b>	<b>H_acdc</b>	<b>Time constant 0 for handle feed</b>
			Select the time constant for manual handle feed. 0: Use time constant for G01 1: Time constant 0 (step)
	<b>#1195</b>	<b>Mmac</b>	<b>Macro call for M command</b>
			Select whether to enable or disable M command macro call of user macro. 0: Disable 1: Enable
	<b>#1196</b>	<b>Smac</b>	<b>Macro call for S command</b>
			Select whether to enable or disable S command macro call of user macro. 0: Disable 1: Enable
	<b>#1197</b>	<b>Tmac</b>	<b>Macro call by command T</b>
			Select whether to enable a call of user macro using command T. 0: Disable macro call 1: Enable macro call, irrespective of the number of command T digits 2: Enable macro call when a tool No. (excluding 0) is given to the upper digit of command T 3: Enable macro call when a tool No. (including 0) is given to the upper digit of command T.
	<b>#1198</b>	<b>M2mac</b>	<b>Macro call with 2nd miscellaneous code</b>
			Select whether to enable or disable 2nd miscellaneous command macro call of user macro. 0: Disable 1: Enable
	<b>#1199</b>	<b>Sselect</b>	<b>Select initial spindle control</b>
			Select the initial condition of spindle control after power is turned ON. 0: 1st spindle control mode (G43.1) 1: 2nd spindle control mode (G44.1) 2: All spindle simultaneously control mode (G47.1) (Note) While G43.1 or G44.1 command is given, the spindle No. is selected with "#12090 SnG43.1" or "#1534 SnG44.1".
<b>(PR)</b>	<b>#1200</b>	<b>G0_acc</b>	<b>Validate acceleration and deceleration with inclination constant G0</b>
			Select the acceleration and deceleration type when a rapid traverse command is issued. 0: Acceleration and deceleration with constant time (conventional type) 1: Acceleration and deceleration with a constant angle of inclination (Note) When rapid traverse constant-gradient multi-step acceleration/deceleration is valid, this parameter will be invalid.
<b>(PR)</b>	<b>#1201</b>	<b>G1_acc</b>	<b>Validate acceleration and deceleration with inclination constant G1</b>
			Select the acceleration and deceleration type when a linear interpolation command is issued. 0: Acceleration and deceleration with constant time (conventional type) 1: Acceleration and deceleration with a constant angle of inclination
	<b>#1202</b>	<b>mirofs</b>	<b>Distance between facing turrets (for L system only)</b>
			Set the distance between tools (edges) (between facing turrets). <b>---Setting range---</b> 0 to 99999.999 (mm)
	<b>#1203</b>	<b>TmirS1</b>	<b>Select turrets as facing turrets with T command (for L system only)</b>
			Select the turrets, which correspond to the tool Nos. 1 to 32, as facing turrets for T code mirror image. <b>---Setting range---</b> 0 to FFFFFFFF

#1204	TmirS2	Select turrets as facing turrets with T command (for L system only)
-------	--------	---

Select the turrets, which correspond to the tool Nos. 33 to 64, as facing turrets for T code mirror image.

---Setting range---

0 to FFFFFFFF

#1205	G0bdcc	Acceleration and deceleration before G0 interpolation
-------	--------	---

0: Post-interpolation acceleration/deceleration is applied to G00.

1: Pre-interpolation acceleration/deceleration is applied to G00 even in the high accuracy control mode.

2: Rapid traverse constant-gradient multi-step acceleration/deceleration is enabled.

When the multi-part system simultaneous high-accuracy control option is enabled, "1" can be set for the 2nd part system and the following.

#1206	G1bF	Maximum speed
-------	------	---------------

Set a cutting feedrate when applying pre-interpolation acceleration/deceleration.

When high-accuracy control time constant expansion is valid, set the maximum of cutting feed clamp speed of each axis.

---Setting range---

1 to 999999 (mm/min)

#1207	G1btL	Time constant
-------	-------	---------------

Set a cutting feed time constant when applying pre-interpolation acceleration/deceleration.

When set to "0", the time constant will be clamped at 1ms.

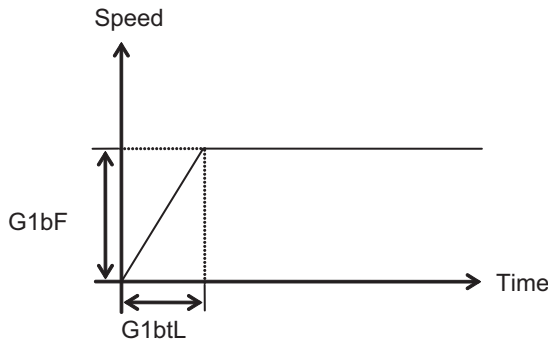

---Setting range---

Without high-accuracy control time constant expansion: 1 to 5000 (ms)

With high-accuracy control time constant expansion: 1 to 30000 (ms)

**Cutting feed Acc Cutting feed acceleration**

Displays cutting feed acceleration.

#1208	RCK	Arc radius error compensation factor
-------	-----	--------------------------------------

Set a coefficient for arc radius error compensation.

An arc radius error compensation amount can be increased or decreased between -60.0 and +20.0%.

---Setting range---

-60.0 to +20.0 (%)

#1209	cirdcc	Arc deceleration speed
-------	--------	------------------------

Set the deceleration speed at the arc entrance or exit.

---Setting range---

1 to 999999 (mm/min)

#1210	RstGmd	Modal G code reset
-------	--------	--------------------

Select whether to initialize G code group modals and H and D codes, which corresponds to bits as follows, when the system is reset.

0: Initialize.

1: Not initialize.

<Description of bits for M system>

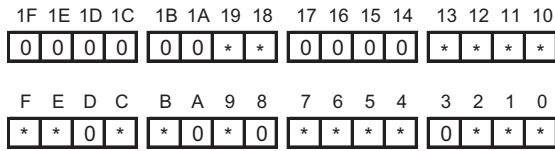

- bit 1F: (Not used)
- bit 1E: (Not used)
- bit 1D: (Not used)
- bit 1C: (Not used)
- bit 1B: (Not used)
- bit 1A: (Not used)
- bit 19: Spindle clamp rotation speed initialization
- bit 18: H, D codes initialization
- bit 17: (Not used)
- bit 16: (Not used)
- bit 15: (Not used)
- bit 14: (Not used)
- bit 13: Group 20 2nd spindle control modal initialization
- bit 12: Group 19 G command mirror modal initialization
- bit 11: Group 18 Polar coordinate command modal initialization
- bit 10: Group 17 Constant surface speed control command modal initialization
- bit F: Group 16 Retains inclined surface machining modal
- bit E: Group 15 Normal line control modal initialization
- bit D: (Not used)
- bit C: Group 13 Cutting modal initialization
- bit B: Group 12 Workpiece coordinate system modal initialization
- bit A: (Not used)
- bit 9: Group 10 Fixed cycle return command modal initialization
- bit 8: (Not used)
- bit 7: Group 8 Length compensation modal initialization
- bit 6: Group 7 Radius compensation modal initialization
- bit 5: Group 6 Inch/metric modal initialization
- bit 4: Group 5 Feed G modal initialization
- bit 3: (Not used)
- bit 2: Group 3 Absolute/incremental command modal initialization
- bit 1: Group 2 Plane selection modal initialization
- bit 0: Group 1 Move G modal initialization

The H code indicates the tool length offset number, and the D code indicates the tool radius compensation number.

When bit 18 is set to ON, the H and D codes and group 8 G modal are retained.

When bit 7 is set to ON, the H code and group 8 G modal are retained.

<Description of bits for L system>

1F	1E	1D	1C	1B	1A	19	18	17	16	15	14	13	12	11	10
0	0	0	0	0	0	*	0	0	0	0	0	*	0	*	*
F	E	D	C	B	A	9	8	7	6	5	4	3	2	1	0
*	*	0	*	*	0	*	0	0	*	*	*	*	*	*	*

**bit 1F: (Not used)**

**bit 1E: (Not used)**

**bit 1D: (Not used)**

**bit 1C: (Not used)**

**bit 1B: (Not used)**

**bit 1A: (Not used)**

**bit 19: Spindle clamp rotation speed initialization**

**bit 18: (Not used)**

**bit 17: (Not used)**

**bit 16: (Not used)**

**bit 15: (Not used)**

**bit 14: (Not used)**

**bit 13: Group 20 2nd spindle control modal initialization**

**bit 12: (Not used)**

**bit 11: Group 18 Balance cut initialization**

**bit 10: Group 17 Constant surface speed control command modal initialization**

**bit F: Group 16 Retains inclined surface machining modal**

**bit E: Group 15 Facing turret mirror image initialization**

**bit D: (Not used)**

**bit C: Group 13 Cutting modal initialization**

**bit B: Group 12 Workpiece coordinate system modal initialization**

**bit A: (Not used)**

**bit 9: Group 10 Fixed cycle return command modal initialization**

**bit 8: (Not used)**

**bit 7: (Not used)**

**bit 6: Group 7 Nose R compensation modal initialization**

**bit 5: Group 6 Inch/metric modal initialization**

**bit 4: Group 5 Feed G modal initialization**

**bit 3: Group 4 Barrier check modal initialization**

**bit 2: Group 3 Absolute/incremental command modal initialization**

**bit 1: Group 2 Plane selection modal initialization**

**bit 0: Group 1 Move G modal initialization**

<b>(PR)</b>	<b>#1213</b>	<b>proaxy</b>	<b>Side 1 of inclination angle (for L system only)</b>
			Specify the length of the side of the triangle formed by the tilt angle in line with the rectangular coordinate system of the inclined axis.
			<b>---Setting range---</b>
			-9999.999 to 9999.999
<b>(PR)</b>	<b>#1214</b>	<b>macaxy</b>	<b>Side 2 of inclination angle (for L system only)</b>
			Specify the length of the side of the triangle formed by the tilt angle in line with the actual axis of the inclined axis.
			<b>---Setting range---</b>
			-9999.999 to 9999.999
<b>(PR)</b>	<b>#1215</b>	<b>macaxx</b>	<b>Side 3 of inclination angle (for L system only)</b>
			Specify the length of the side of the triangle formed by the tilt angle in line with the actual axis of the base axis corresponding to the inclined axis.
			<b>---Setting range---</b>
			-9999.999 to 9999.999
	<b>#1216</b>	<b>extdcc</b>	<b>External deceleration speed</b>
			Set the upper limit value of the feedrate when the external deceleration signals are enabled.
			<b>---Setting range---</b>
			1 to 999999 (mm/min)
	<b>#1501</b>	<b>polyax</b>	<b>Rotational tool axis number (for L system only)</b>
			Specify the number of the rotational tool axis (servo axis) used for polygon machining (G51.2).
			Set "0" when not using polygon machining (spindle-servo axis), or when using spindle-spindle polygon machining.
			A value exceeding the base specification parameter "#1002 axisno" cannot be specified.
			This parameter is valid when the G code system is 6 or 7 ("7" or "8" is set in the parameter "#1037 cmdtyp").
			<b>---Setting range---</b>
			0 to controlled axis number
	<b>#1502</b>	<b>G0lpfg</b>	<b>G1 -&gt; G0 deceleration check</b>
			Select whether to perform a deceleration check when the travel direction is changed from G1 to G0.
			0: Not perform
			1: Perform
	<b>#1503</b>	<b>G1lpfg</b>	<b>G1 -&gt; G1 deceleration check</b>
			Select whether to perform a deceleration check when the travel direction is changed from G1 to G1.
			0: Not perform
			1: Perform
	<b>#1505</b>	<b>ckref2</b>	<b>Second reference position return check</b>
			Select whether the check is carried out at the specified position in manual second reference position return mode upon completion of spindle orientation or at second reference position return interlock signal.
			0: Upon completion of spindle orientation
			1: At second reference position return interlock signal
	<b>#1506</b>	<b>F1_FM</b>	<b>Upper limit of F 1-digit feedrate</b>
			Set the maximum value up to which the F 1-digit feedrate can be changed.
			<b>---Setting range---</b>
			0 to 1000000 (mm/min)
	<b>#1507</b>	<b>F1_K</b>	<b>F 1-digit feedrate change constant</b>
			Set the constant that determines the speed change rate per manual handle graduation in F 1-digit feedrate change mode.
			<b>---Setting range---</b>
			0 to 32767



<b>#1510</b>	<b>DOOR_H</b>	<b>Shorten door interlock II axis stop time</b>
<p>Select whether to shorten the time during which the axis is stopped when the door is opened.</p> <p>0: Use the conventional axis stop time.</p> <p>1: Shorten the axis stop time.</p> <p>(Note) When the door interlock II signal is input via a ladder, the conventional axis stop time will be used.</p>		
<b>#1511</b>	<b>DOORPm</b>	<b>Signal input device 1 for door interlock II: for each part system</b>
<p>Set the fixed device number for door interlock II signal input for each part system.</p> <p>A device number from X01 to XFF can be specified. (Except X100.)</p> <p>Device number "000" is invalid.</p> <p>Set device number "100" when using no fixed device number for door interlock II signal input.</p> <p>Related parameter: "#1154 pdoor" (Door interlock II for each part system)</p> <p><b>---Setting range---</b></p> <p>000 to 2FF (hexadecimal)</p>		
<b>#1512</b>	<b>DOORPs</b>	<b>Signal input device 2 for door interlock II: for each part system</b>
<p>Set the fixed device number for door interlock II signal input for each part system.</p> <p>(Set the same value as that of "#1155 DOOR_m".)</p> <p>Related parameter: "#1154 pdoor" (Door interlock II for each part system)</p> <p><b>---Setting range---</b></p> <p>000 to 2FF (hexadecimal)</p>		
<b>#1513</b>	<b>stapM</b>	<b>M code for synchronous tap selection</b>
<p>Set the M code for the synchronous tapping selection.</p> <p>Select the synchronous tapping mode using the miscellaneous function code of the value set in this parameter. The M function command can be issued immediately before the tap command or in the same block. This function is valid only when "1" is set in "#1272 ext08/bit1" (M-function synchronous tap cycle).</p> <p>(Note) Do not use M00, 01 02, 30, 98, and 99.</p> <p><b>---Setting range---</b></p> <p>0 to 99999999</p>		
<b>#1514</b>	<b>expLinax</b>	<b>Exponential function interpolation linear axis</b>
<p>Not used. Set to "0".</p>		
<b>#1515</b>	<b>expRotax</b>	<b>Exponential function interpolation rotary axis</b>
<p>Not used. Set to "0".</p>		
<b>#1516</b>	<b>mill_ax</b>	<b>Milling axis name</b>
<p>Set the name of the rotary axis used in milling interpolation. Only one rotary axis can be set.</p> <p>When there is no E command in issuing the G12.1 command, this parameter will be followed.</p> <p><b>---Setting range---</b></p> <p>A to Z</p>		
<b>#1517</b>	<b>mill_C</b>	<b>Milling interpolation hypothetical axis name</b>
<p>Select the hypothetical axis command name for milling interpolation.</p> <p>When there is no D command in issuing the milling interpolation command, this parameter will be followed.</p> <p>0: Y axis command</p> <p>1: Command rotary axis name.</p>		

	<b>#1518</b>	<b>polm</b>	<b>Spindle-spindle polygon Workpiece spindle No.</b>
	Set the name or No. of the spindle which controls the workpiece used in spindle-spindle polygon machining. (Note 1) The 1st spindle will be selected when "0" is set. (Note 2) There are 2 spindle designation methods: spindle No. method and spindle name method. When names (any of 1 to 9) are set by the parameter "#3077 Sname" (Spindle command name) for all spindles, spindle name method is applied. Otherwise, spindle No. method is applied.		
	<b>---Setting range---</b>		
	0 to 9		
	<b>#1519</b>	<b>pols</b>	<b>Spindle-spindle polygon Tool spindle No.</b>
	Set the name or No. of the spindle which controls the rotary tool used in spindle-spindle polygon machining. (Note 1) The 2nd spindle will be selected when "0" is set. (Note 2) There are 2 spindle designation methods: spindle No. method and spindle name method. When names (any of 1 to 9) are set by the parameter "#3077 Sname" (Spindle command name) for all spindles, spindle name method is applied. Otherwise, spindle No. method is applied.		
	<b>---Setting range---</b>		
	0 to 9		
<b>(PR)</b>	<b>#1520</b>	<b>Tchg34</b>	<b>Additional axis tool compensation operation (for L system only)</b>
	Select axis to carry out the additional axis' tool compensation function. 0: 3rd axis. 1: 4th axis.		
	<b>#1521</b>	<b>C_min</b>	<b>Minimum turning angle</b>
	Set the minimum turning angle of the normal line control axis at the block joint during normal line control.		
	<b>---Setting range---</b>		
	0.000 to 360.000 (°) (Input setting increment applies)		
<b>(PR)</b>	<b>#1522</b>	<b>C_axis</b>	<b>Normal line control axis</b>
	Set the number of the axis for normal line control. Set a rotary axis No. 0: Normal line control disabled 1 to 16: Axis No. (number of control axes)		
	<b>#1523</b>	<b>C_feed</b>	<b>Normal line control axis turning speed</b>
	Set the turning speed of the normal line control axis at the block joint during normal line control. Set a value that does not exceed the normal line control axis' clamp speed ("#2002 clamp"). This is enabled during the normal line control type I.		
	<b>---Setting range---</b>		
	0 to 100000 (°/min)		
	<b>#1524</b>	<b>C_type</b>	<b>Normal line control type</b>
	Select the normal line control type. 0: Normal line control type I 1: Normal line control type II		
	<b>#1533</b>	<b>millPax</b>	<b>Pole coordinate linear axis name</b>
	Set the linear axis name used for pole coordinate interpolation.		
	<b>---Setting range---</b>		
	Axis names such as X, Y or Z		

<b>(PR)</b>	<b>#1534</b>	<b>SnG44.1</b>	<b>Spindle No. for G44.1 command</b>
			<p>Specify which spindle to be selected when G44.1 is commanded.                  &lt;Spindle No. type&gt;                  Specify by the spindle No. 1 to 8.                  The 2nd spindle is selected if you specify a nonexistent spindle No.                  &lt;Spindle name type&gt;                  Specify by the spindle name 1 to 9.                  The 2nd spindle is selected if you specify a nonexistent spindle name.</p> <p>(Note) When names (any of 1 to 9) are for all spindles by the parameter "#3077 Sname" (Spindle command name), "Spindle name type" is applied.</p> <p><b>---Setting range---</b>                  0 to 9</p>
	<b>#1535</b>	<b>C_leng</b>	<b>Minimum turning movement amount</b>
			<p>Set the minimum turning movement amount of the normal line control axis at the block joint during normal line control.</p> <p><b>---Setting range---</b>                  0.000 to 99999.999 (mm) (Input setting increment applies)</p>
	<b>#1537</b>	<b>crsax[1]</b>	<b>Mixed control (cross axis control) axis</b>
			<p>Set the axis to be interchanged during the mixed control (cross axis control).                  Using two digits, set the name of the axis to be interchanged with the axis in the part system where the mixed control (cross axis control) request signal is input, or the name of the axis to be shifted to that part system.</p> <p><b>---Setting range---</b>                  Two digits between A to Z and 1 to 9                  (Setting is cleared when "0" is set)</p>
	<b>#1538</b>	<b>crsax[2]</b>	<b>Mixed control (cross axis control) axis</b>
			<p>Set the axis to be interchanged during the mixed control (cross axis control).                  Using two digits, set the name of the axis to be interchanged with the axis in the part system where the mixed control (cross axis control) request signal is input, or the name of the axis to be shifted to that part system.</p> <p><b>---Setting range---</b>                  Two digits between A to Z and 1 to 9                  (Setting is cleared when "0" is set)</p>
	<b>#1539</b>	<b>crsax[3]</b>	<b>Mixed control (cross axis control) axis</b>
			<p>Set the axis to be interchanged during the mixed control (cross axis control).                  Using two digits, set the name of the axis to be interchanged with the axis in the part system where the mixed control (cross axis control) request signal is input, or the name of the axis to be shifted to that part system.</p> <p><b>---Setting range---</b>                  Two digits between A to Z and 1 to 9                  (Setting is cleared when "0" is set)</p>
	<b>#1540</b>	<b>crsax[4]</b>	<b>Mixed control (cross axis control) axis</b>
			<p>Set the axis to be interchanged during the mixed control (cross axis control).                  Using two digits, set the name of the axis to be interchanged with the axis in the part system where the mixed control (cross axis control) request signal is input, or the name of the axis to be shifted to that part system.</p> <p><b>---Setting range---</b>                  Two digits between A to Z and 1 to 9                  (Setting is cleared when "0" is set)</p>

<b>#1541</b>	<b>crsax[5]</b>	<b>Mixed control (cross axis control) axis</b>
Set the axis to be interchanged during the mixed control (cross axis control).		
Using two digits, set the name of the axis to be interchanged with the axis in the part system where the mixed control (cross axis control) request signal is input, or the name of the axis to be shifted to that part system.		
<b>---Setting range---</b>		
Two digits between A to Z and 1 to 9 (Setting is cleared when "0" is set)		
<b>#1542</b>	<b>crsax[6]</b>	<b>Mixed control (cross axis control) axis</b>
Set the axis to be interchanged during the mixed control (cross axis control).		
Using two digits, set the name of the axis to be interchanged with the axis in the part system where the mixed control (cross axis control) request signal is input, or the name of the axis to be shifted to that part system.		
<b>---Setting range---</b>		
Two digits between A to Z and 1 to 9 (Setting is cleared when "0" is set)		
<b>#1543</b>	<b>crsax[7]</b>	<b>Mixed control (cross axis control) axis</b>
Set the axis to be interchanged during the mixed control (cross axis control).		
Using two digits, set the name of the axis to be interchanged with the axis in the part system where the mixed control (cross axis control) request signal is input, or the name of the axis to be shifted to that part system.		
<b>---Setting range---</b>		
Two digits between A to Z and 1 to 9 (Setting is cleared when "0" is set)		
<b>#1544</b>	<b>crsax[8]</b>	<b>Mixed control (cross axis control) axis</b>
Set the axis to be interchanged during the mixed control (cross axis control).		
Using two digits, set the name of the axis to be interchanged with the axis in the part system where the mixed control (cross axis control) request signal is input, or the name of the axis to be shifted to that part system.		
<b>---Setting range---</b>		
Two digits between A to Z and 1 to 9 (Setting is cleared when "0" is set)		
<b>#1558</b>	<b>lvOMin</b>	<b>Involute interpolation override lower limit value</b>
Not used.		
<b>#1559</b>	<b>lvAMax</b>	<b>Involute interpolation allowable acceleration speed</b>
Not used.		
<b>#1560</b>	<b>lvFMin</b>	<b>Involute interpolation minimum feedrate</b>
Not used.		
<b>#1561</b>	<b>3Dcdc</b>	<b>Switch workpiece coordinate display during 3D coordinate conversion</b>
The workpiece coordinate display during 3D coordinate conversion is switched to the workpiece coordinate system or G68 program coordinate system.		
0: Workpiece coordinate system 1: G68 program coordinate system		
(Note) The special display unit's absolute coordinates also follow this parameter setting.		
<b>#1562</b>	<b>3Dremc</b>	<b>Switch remaining command display during 3D coordinate conversion</b>
The remaining command display during 3D coordinate conversion is switched to the workpiece coordinate system or G68 program coordinate system.		
0: Workpiece coordinate system 1: G68 program coordinate system		

<b>#1563</b>	<b>3Dcsrc</b>	<b>Switch coordinate reading during 3D coordinate conversion</b>
<p>The coordinate system of the workpiece/skip coordinate read value in the 3D coordinate conversion modal is switched.</p> <p>0: G68 program coordinate system 1: Workpiece (local) coordinate system</p>		
<b>#1564</b>	<b>3Dspd</b>	<b>Hole drilling speed during 3D coordinate conversion</b>
<p>Set the rapid traverse rate for the hole drilling cycle during 3D coordinate conversion.</p> <p>0: The cutting feed clamp speed is used. Other than 0: The set speed is used.</p> <p>Note that if the rapid traverse rate is exceeded, the speed will be clamped at the rapid traverse rate.</p> <p>---Setting range--- 0 to 1000000mm/min</p>		
<b>#1565</b>	<b>helgear</b>	<b>Helical machining base axis</b>
<p>Set the base axis for helix angle calculation in helical machining. When no setting, Z axis will be used.</p> <p>---Setting range--- Axis name such as X, Y, Z, U, V, W, A, B, and C</p>		
<b>#1566</b>	<b>3DselctDrillaxMode</b>	<b>Switch drill axis's mode from rapid traverse during 3D coordinate conversion</b>
<p>Switch the rapid traverse mode in non-drilling blocks among a drilling cycle to the cutting feed mode during 3-dimensional coordinate conversion.</p> <p>0: Rapid traverse mode. The speed follows the setting of "#2001 rapid". 1: Cutting feed mode. The speed follows the setting of "#1564 3Dspd".</p>		
<b>#1568</b>	<b>SfiltG1</b>	<b>G01 soft acceleration/deceleration filter</b>
<p>Set the filter time constant for smoothly changing the acceleration rate for the cutting feed acceleration/deceleration in pre-interpolation acceleration/deceleration.</p> <p>- Notch frequency Hz Displays the notch frequency (Hz) for the S-pattern filter set in "#1568 SfiltG1" (G01 soft acceleration/deceleration filter).</p> <p>---Setting range--- 0 to 200 (ms)</p>		
<b>#1569</b>	<b>SfiltG0</b>	<b>G00 soft acceleration/deceleration filter</b>
<p>Set the filter time constant for smoothly changing the acceleration rate for the rapid traverse acceleration/deceleration in pre-interpolation acceleration/deceleration.</p> <p>---Setting range--- 0 to 200 (ms)</p>		
<b>#1570</b>	<b>Sfilt2</b>	<b>Soft acceleration/deceleration filter 2</b>
<p>Set the filter time constant for smoothly changing the acceleration rate in pre-interpolation acceleration/deceleration.</p> <p>This will be disabled when "0" or "1" is set.</p> <p>- Notch frequency Hz Displays the notch frequency (Hz) for the S-shape filter set in "#1570 Sfilt2" (Soft acceleration/deceleration filter 2).</p> <p>---Setting range--- 0 to 200 (ms)</p>		
<b>#1571</b>	<b>SSSdis</b>	<b>SSS control adjustment coefficient fixed value selection</b>
<p>Fix the shape recognition range for SSS control.</p> <p>---Setting range--- 0/1</p>		

#1572	Cirorp	Arc command overlap
		<p>This eliminates speed fluctuations at the joint of the arc and straight line and arc and arc. Set as a bit unit.</p> <p>0: Do not overlap the arc command blocks 1: Overlap the arc command blocks</p> <p><b>bit0: Arc command during high-speed high-accuracy control II</b> <b>bit1: Arc command during high-speed machining mode II</b> <b>bit2: Arc command during high-accuracy control (G61.1)</b> <b>bit3: Arc command during cutting mode (G64)</b></p> <p>The line command block and arc command block won't be overlapped during G61.2 modal regardless of this setting. (Note) This parameter is invalid during SSS control.</p> <p><b>---Setting range---</b> 0 to F (HEX)</p>
#1573	Ret1	Return type 1
		<p>Select the axis to be moved later after tool return. This is referred to with the movement path (transit point #1 -&gt; interrupt point). Up to eight axes can be specified by expressing one axis with one bit.</p> <p><b>bit0: Transit point #1 1st axis</b> <b>bit1: Transit point #1 2nd axis</b> <b>bit2: Transit point #1 3rd axis</b> <b>bit3: Transit point #1 4th axis</b> <b>bit4: Transit point #1 5th axis</b> <b>bit5: Transit point #1 6th axis</b> <b>bit6: Transit point #1 7th axis</b> <b>bit7: Transit point #1 8th axis</b></p> <p><b>---Setting range---</b> 00000000 to 11111111 (Binary)</p>
#1574	Ret2	Return type 2
		<p>Select the axis to be moved later after tool return. This is referred to with the movement path (return start point -&gt; transit point #2). Up to eight axes can be specified by expressing one axis with one bit.</p> <p><b>bit0: Transit point #2 1st axis</b> <b>bit1: Transit point #2 2nd axis</b> <b>bit2: Transit point #2 3rd axis</b> <b>bit3: Transit point #2 4th axis</b> <b>bit4: Transit point #2 5th axis</b> <b>bit5: Transit point #2 6th axis</b> <b>bit6: Transit point #2 7th axis</b> <b>bit7: Transit point #2 8th axis</b></p> <p><b>---Setting range---</b> 00000000 to 11111111 (Binary)</p>

	<b>#1595</b>	<b>hobm</b>	<b>Hobbing rotary tool axis No.</b>
	Specify the spindle No. or spindle name of rotary tool in "MITSUBISHI CNC Special Format (G81.4)" of hobbing command.		
	(Note) There are 2 spindle designation methods: spindle No. method and spindle name method. When names (any of 1 to 9) are set by the parameter "#3077 Sname" (Spindle command name) for all spindles, spindle name method is applied. Otherwise, spindle No. method is applied.		
	<b>---Setting range---</b>		
	0 to 9		
	<b>#1596</b>	<b>hobs</b>	<b>Hobbing workpiece axis No.</b>
	Specify the NC axis No. of workpiece axis (in a part system) in "MITSUBISHI CNC Special Format (G81.4)" of hobbing command.		
	This parameter is valid when "#1292 ext28/bit4" (Hobbing workpiece axis selection switch) is "0".		
	<b>---Setting range---</b>		
	1 to the number of NC axes (in a part system)		
	<b>#1599</b>	<b>3DEndPointErr</b>	<b>End point error in 3D coordinate conversion</b>
	Not used.		
	<b>#12001</b>	<b>ManualB RectanA xH</b>	<b>Manual feed rate B constant surface control intersecting part system axis name (horizontal)</b>
	Not used. Set to "0".		
	<b>#12002</b>	<b>ManualB RectanA xV</b>	<b>Manual feed rate B constant surface control intersecting part system axis name (vertical)</b>
	Not used. Set to "0".		
	<b>#12003</b>	<b>ManualB RotCent erH</b>	<b>Manual feed rate B constant surface control rotation center machine position (horizontal)</b>
	Not used. Set to "0.000".		
	<b>#12004</b>	<b>ManualB RotCent erV</b>	<b>Manual feed rate B constant surface control rotation center machine position (vertical)</b>
	Not used. Set to "0.000".		
<b>(PR)</b>	<b>#12005</b>	<b>Mfig</b>	<b>Number of M</b>
	Set the number of M codes that can be specified within the same block.		
	<b>---Setting range---</b>		
	1 to 6		
<b>(PR)</b>	<b>#12006</b>	<b>Mbin</b>	<b>M binary</b>
	Data type 0: BCD		
	Data type 1: Unsigned binary		
	Data type -1: Signed binary		
	<For unsigned binary>		
	The absolute value "1" is output for "-1".		
	<For signed binary>		
	"-1" is output as "0xFFFFFFFF".		
	<b>---Setting range---</b>		
	Data type		
	(-1,0,1)		
<b>(PR)</b>	<b>#12007</b>	<b>Sfig</b>	<b>Number of S</b>
	Set the number of spindles.		
	(Note 1) The setting range differs according to the model.		
	(Note 2) "Sfig" is set in the range of 1 to 8. However, the number of outputs by "Sfig" cannot be controlled. Thus, only one S command is output regardless of the Sfig setting value.		
	<b>---Setting range---</b>		
	1 to 8		

(PR)	#12008	Sbin	S binary
		Data type 0: BCD Data type 1: Unsigned binary Data type -1: Singed binary	
		<For unsigned binary> The absolute value "1" is output for "-1". <For singed binary> "-1" is output as "0xFFFFFFFF". (Note 1) Sbin can be set with "-1", "0" and "1", but the S command cannot be BCD output. If BCD (0) is selected for Sbin, it will be handled as a singed binary (-1).	
		<b>---Setting range---</b> Data type (-1,0,1)	
(PR)	#12009	Tfig	Number of T
		Set the number of T codes that can be specified within the same block.	
		<b>---Setting range---</b> 1 to 4	
(PR)	#12010	Tbin	T binary
		Data type 0: BCD Data type 1: Unsigned binary Data type -1: Singed binary	
		<For unsigned binary> The absolute value "1" is output for "-1". <For singed binary> "-1" is output as "0xFFFFFFFF".	
		<b>---Setting range---</b> Data type (-1,0,1)	
(PR)	#12011	Bfig	Number of B
		Set the number of B codes that can be specified within the same block.	
		<b>---Setting range---</b> 1 to 4	
(PR)	#12012	Bbin	B binary
		Data type 0: BCD Data type 1: Unsigned binary Data type -1: Singed binary	
		<For unsigned binary> The absolute value "1" is output for "-1". <For singed binary> "-1" is output as "0xFFFFFFFF".	
		<b>---Setting range---</b> Data type (-1,0,1)	



	<b>#12013</b>	<b>G33.n rot</b>	<b>G33.n rotary axis name</b>
			Select the axis to use as C axis with its axis name.
			<b>---Setting range---</b>
			A to Z
	<b>#12014</b>	<b>G33.n ovr</b>	<b>G33.n override</b>
			Not used.
<b>(PR)</b>	<b>#12015</b>	<b>v_dist</b>	<b>Hypothetical axis tool length</b>
			In hypothetical linear axis control, specify the length between the tool center and the center of rotation of the actual rotary axis that lies in the hypothetical plane.
			Setting "0" disables the hypothetical axis.
			<b>---Setting range---</b>
			0 to 99999.999 (mm)
<b>(PR)</b>	<b>#12016</b>	<b>v_ori</b>	<b>Hypothetical axis machine zero</b>
			Specify the distance from the hypothetical axis machine zero to the center of rotation of the rotary axis.
			When the rotation center is located to the left of the origin, enter a negative value.
			<b>---Setting range---</b>
			-99999.999 to 99999.999 (mm)
<b>(PR)</b>	<b>#12017</b>	<b>ofsang</b>	<b>Actual rotary axis compensation angle</b>
			Specify the angle formed with the vector from the rotation center of C axis (actual axis) that lies in the hypothetical plane to the tool, while the C axis is at 0 degrees when viewed from the positive end of X axis (hypothetical axis).
			<b>---Setting range---</b>
			0 to 359.999 (deg)
	<b>#12018</b>	<b>CIAng1</b>	<b>Angle 1 in conversion</b>
			Specify which solution to use when there are two solutions that have identical travel distance in Y axis with the rotary axis being at 0 degrees when viewed from the positive end of X axis.
			0: Solution between 0 and 90 degrees when viewed from the positive end of X axis
			1: Solution between 270 and 360 degrees when viewed from the positive end of X axis
	<b>#12019</b>	<b>CIAng2</b>	<b>Angle 2 in conversion</b>
			Specify which solution to use when there are two solutions that have identical travel distance in Y axis with the rotary axis being at 180 degrees when viewed from the positive end of X axis.
			0: Solution between 90 and 180 degrees when viewed from the positive end of X axis
			1: Solution between 180 and 270 degrees when viewed from the positive end of X axis
<b>(PR)</b>	<b>#12020</b>	<b>r_lim+</b>	<b>Actual axis movable range (+)</b>
			Specify the movable range in the positive direction of the actual linear axis that lies in the hypothetical plane in the hypothetical axis mode. Use the distance from the machine zero to specify the range.
			<b>---Setting range---</b>
			0 to 99999.999 (mm)
<b>(PR)</b>	<b>#12021</b>	<b>r_lim-</b>	<b>Actual axis movable range (-)</b>
			Specify the movable range in the negative direction of the actual linear axis that lies in the hypothetical plane in the hypothetical axis mode. Use the distance from the machine zero to specify the range.
			<b>---Setting range---</b>
			0 to 99999.999 (mm)

	<b>#12022</b>	<b>skipF_spec</b>	
		<b>bit0: Skip speed spec: Cutting feed override ON</b>	
		Select whether to enable cutting feed override for a skip command.	
		0: Disable cutting feed override	
		1: Enable cutting feed override	
		<b>bit1: Skip speed spec: Dry run ON</b>	
		Select whether to enable dry run for a skip command.	
		0: Disable dry run	
		1: Enable dry run	
		<b>bit2: Skip speed spec: Feed rate selection</b>	
		Select the feed rate for a skip command.	
		0: A feed rate given to address F of the G31 block. If the G31 block has no address F, the value specified by "#1174 skip_F" is applied. In either case the F modal status is unchanged.	
		1: A feed rate programmed as an F modal value. F modal status is updated by the address F given to the G31 block.	
<b>(PR)</b>	<b>#12023</b>	<b>Mblkstp1</b>	<b>Pre-read prohibited M code 1</b>
		Set M codes to which pre-read will not be applied.	
		<b>---Setting range---</b>	
		0 to 99999999	
<b>(PR)</b>	<b>#12024</b>	<b>Mblkstp2</b>	<b>Pre-read prohibited M code 2</b>
		Set M codes to which pre-read will not be applied.	
		<b>---Setting range---</b>	
		0 to 99999999	
<b>(PR)</b>	<b>#12025</b>	<b>Mblkstp3</b>	<b>Pre-read prohibited M code 3</b>
		Set M codes to which pre-read will not be applied.	
		<b>---Setting range---</b>	
		0 to 99999999	
<b>(PR)</b>	<b>#12026</b>	<b>Mblkstp4</b>	<b>Pre-read prohibited M code 4</b>
		Set M codes to which pre-read will not be applied.	
		<b>---Setting range---</b>	
		0 to 99999999	
<b>(PR)</b>	<b>#12027</b>	<b>Mblkstp5</b>	<b>Pre-read prohibited M code 5</b>
		Set M codes to which pre-read will not be applied.	
		<b>---Setting range---</b>	
		0 to 99999999	
<b>(PR)</b>	<b>#12028</b>	<b>Mblkstp6</b>	<b>Pre-read prohibited M code 6</b>
		Set M codes to which pre-read will not be applied.	
		<b>---Setting range---</b>	
		0 to 99999999	
<b>(PR)</b>	<b>#12029</b>	<b>Mblkstp7</b>	<b>Pre-read prohibited M code 7</b>
		Set M codes to which pre-read will not be applied.	
		<b>---Setting range---</b>	
		0 to 99999999	
<b>(PR)</b>	<b>#12030</b>	<b>Mblkstp8</b>	<b>Pre-read prohibited M code 8</b>
		Set M codes to which pre-read will not be applied.	
		<b>---Setting range---</b>	
		0 to 99999999	

(PR)	#12031	Mblkstp9	Pre-read prohibited M code 9
			Set M codes to which pre-read will not be applied.
			---Setting range---
			0 to 99999999
(PR)	#12032	Mblkstp10	Pre-read prohibited M code 10
			Set M codes to which pre-read will not be applied.
			---Setting range---
			0 to 99999999
(PR)	#12033	MblkstpMin1	Minimum value of the pre-read prohibited M code range setting 1
			Set the minimum value of the M code to which pre-read will not be applied.
			---Setting range---
			0 to 99999999
(PR)	#12034	MblkstpMax1	Maximum value of the pre-read prohibited M code range setting 1
			Set the maximum value of the M code to which pre-read will not be applied.
			---Setting range---
			0 to 99999999
(PR)	#12035	MblkstpMin2	Minimum value of the pre-read prohibited M code range setting 2
			Set the minimum value of the M code to which pre-read will not be applied.
			---Setting range---
			0 to 99999999
(PR)	#12036	MblkstpMax2	Maximum value of the pre-read prohibited M code range setting 2
			Set the maximum value of the M code to which pre-read will not be applied.
			---Setting range---
			0 to 99999999
(PR)	#12037	MblkstpMin3	Minimum value of the pre-read prohibited M code range setting 3
			Set the minimum value of the M code to which pre-read will not be applied.
			---Setting range---
			0 to 99999999
(PR)	#12038	MblkstpMax3	Maximum value of the pre-read prohibited M code range setting 3
			Set the maximum value of the M code to which pre-read will not be applied.
			---Setting range---
			0 to 99999999
(PR)	#12039	MblkstpMin4	Minimum value of the pre-read prohibited M code range setting 4
			Set the minimum value of the M code to which pre-read will not be applied.
			---Setting range---
			0 to 99999999
(PR)	#12040	MblkstpMax4	Maximum value of the pre-read prohibited M code range setting 4
			Set the maximum value of the M code to which pre-read will not be applied.
			---Setting range---
			0 to 99999999

(PR)	#12041	MblkstpMin5	Minimum value of the pre-read prohibited M code range setting 5
Set the minimum value of the M code to which pre-read will not be applied.			
---Setting range---			
0 to 99999999			
(PR)	#12042	MblkstpMax5	Maximum value of the pre-read prohibited M code range setting 5
Set the maximum value of the M code to which pre-read will not be applied.			
---Setting range---			
0 to 99999999			
(PR)	#12043	MblkstpMin6	Minimum value of the pre-read prohibited M code range setting 6
Set the minimum value of the M code to which pre-read will not be applied.			
---Setting range---			
0 to 99999999			
(PR)	#12044	MblkstpMax6	Maximum value of the pre-read prohibited M code range setting 6
Set the maximum value of the M code to which pre-read will not be applied.			
---Setting range---			
0 to 99999999			
	#12049	SBS_no	Sub part system I identification No.
Specify the ID number (address B value) to be used when activating this part system as a sub part system during G122 command. Set to "0" when this part system is not used as a sub part system.			
---Setting range---			
0 to 7			
	#12050	SBS_pro	Sub part system I standard program No.
Specify the No. of program to be called when activating this part system as a sub part system during G122 command. This parameter setting is used when a program designation (address A value/<file name>) is omitted.			
---Setting range---			
0 to 99999999			
	#12051	Jerk_filtG1	G01 jerk filter
Specify the time constant of filter that is used for smoothing the change of jerk when pre-interpolation acceleration/deceleration is performed in cutting feed.			
This filter causes no path error, as the filter is applied to the resultant speed calculated before interpolation.			
If you specify the jerk filter time constant, the time constants of each filter will be as follows:			
- S-shape filter time constant			
"#1568 SfiltG1" - "Jerk_filtG1"			
- Jerk filter time constant			
"Jerk_filtG1"			
---Setting range---			
0 to 50 (ms)			

	<b>#12052</b>	<b>Jerk_filtG0</b>	<b>G00 jerk filter</b>
			Specify the time constant of filter that is used for smoothing the change of jerk when pre-interpolation acceleration/deceleration is performed in cutting feed. This filter causes no path error, as the filter is applied to the resultant speed calculated before interpolation. If you specify the jerk filter time constant, the time constants of each filter will be as follows: - S-shape filter time constant "#1569 SfiltG0" - "Jerk_filtG0" - Jerk filter time constant "Jerk_filtG0" <b>---Setting range---</b> 0 to 50 (ms)
	<b>#12053</b>	<b>EachAxAccCntrl</b>	<b>Enable axis-specific acceleration tolerance control</b>
			Not used. Set to "0".
<b>(PR)</b>	<b>#12054</b>	<b>Tol-Ofsnum</b>	<b>Number of tool offset sets for allocation</b>
			Not used. Set to "0".
<b>(PR)</b>	<b>#12055</b>	<b>Tol-lifenum</b>	<b>Number of life management tools for allocation</b>
			Specify the number of life management tools to be allocated when the arbitrary allocation method is selected for life management tools. <b>---Setting range---</b> 0 to 1000
	<b>#12056</b>	<b>I_G0ol</b>	<b>Enable G00 initial rapid traverse block overlap</b>
			Select the state (enabled or disabled) of the rapid traverse block overlap function after reset. 0: Disabled 1: Enabled
	<b>#12057</b>	<b>OT_prechkON</b>	<b>Enabling stroke check before travel for stored stroke limit</b>
			Not used.
	<b>#12058</b>	<b>OT_prechkTYPE</b>	<b>Stroke check before travel for skip and automatic tool length measurement</b>
			Not used.
	<b>#12059</b>	<b>SBS_name</b>	<b>Sub part system name</b>
			Specify each sub part system name. This name is displayed when the part system acts as a sub part system. <b>---Setting range---</b> 4 or less characters consisting of both alphabets and numbers
	<b>#12060</b>	<b>VblAccPreInt</b>	<b>Variable-acceleration pre-interpolation acceleration/deceleration ON</b>
			Not used. Set to "0".
	<b>#12070</b>	<b>Sfilt2_tol</b>	<b>Tolerance control: Soft acceleration/deceleration filter 2</b>
			Specify the time constant of the filter that smoothes out fluctuations in acceleration under the tolerance control. Basically set to 0. <b>---Setting range---</b> 0 to 200 (ms)

<b>(PR)</b>	<b>#12071-12078</b>	<b>adr_abs[1]-[8]</b>	<b>Command address for arbitrary axis exchange</b>
			Specify the axis address to be given in an arbitrary axis exchange command for the part system. (Note 1) This parameter is disabled when the arbitrary axis exchange function is unused. (Note 2) Do not give an identical name to two or more of the parameters adr_abs[1] to adr_abs[8]. (Note 3) Do not leave any unspecified parameter in the middle between adr_abs[1] and [8]. (Note 4) Set the addresses of adr_abs[ ] in the same order as of the axis names (#1013 axname). Note that you can set a nonexistent axis name in the middle. (Note 5) If there are 9 or more control axes per part system, specify the axis address that is programmed based on the basic axis configuration. <b>---Setting range---</b> Axis address such as X, Y, Z, U, V, W, A, B and C
<b>(PR)</b>	<b>#12079-12086</b>	<b>adr_inc[1]-[8]</b>	<b>Incremental command address for arbitrary axis exchange</b>
			Specify the incremental command address for each of the axes to be used in an arbitrary axis exchange command. (Note 1) This parameter is disabled when the arbitrary axis exchange function is unused. (Note 2) There is no need to set this parameter when command type (absolute or incremental) is not distinguished by the axis address (when "#1076 AbsInc" = "0"). (Note 3) Do not give an identical name to two or more of the parameters adr_inc[1] to adr_inc[8]. If there is any overlap, priority is given in the ascending order (adr_inc[1] to adr_inc[8]). <b>---Setting range---</b> Axis address such as X, Y, Z, U, V, W, A, B and C
	<b>#12088</b>	<b>Drn_F</b>	<b>Dry run speed</b>
			Specify a dry run speed for each part system. When 0 is set, the manual feed rate selected by Manual feedrate method selection (JVS) signal is applied. <b>---Setting range---</b> 0 to 1000000 (mm/min)
	<b>#12089</b>	<b>M2adr</b>	<b>2nd miscellaneous function address type</b>
			Select the address type of the 2nd miscellaneous function. 0: One-letter command for the 2nd miscellaneous function 1: Two-letter command for the 2nd miscellaneous function
<b>(PR)</b>	<b>#12090</b>	<b>SnG43.1</b>	<b>Spindle designation for G43.1</b>
			Specify which spindle to be selected when G43.1 is commanded. <Spindle No. type> Specify by the spindle No. 1 to 8. The 1st spindle is selected if you specify a nonexistent spindle No. <Spindle name type> Specify by the spindle name 1 to 9. The 1st spindle is selected if you specify a nonexistent spindle name.  (Note) When names (any of 1 to 9) are for all spindles by the parameter "#3077 Sname" (Spindle command name), "Spindle name type" is applied. <b>---Setting range---</b> 0 to 9
<b>(PR)</b>	<b>#12103</b>	<b>2nd add T-ofs ON</b>	<b>2nd additional axis tool offset ON (for L system only)</b>
			Select whether to enable tool offset on the 2nd additional axis. 0: Disable 1: Enable

(PR)	#12104	2nd add T-ofs set	2nd additional axis tool offset setting (for L system only)
<p>Select on which axis to perform the 2nd additional axis tool offset. Specify the axis address set in "#1013 axname".</p> <p>---Setting range---</p> <p>X,Y,Z,U,V,W,A,B,C</p>			
	#12105	C_minTyp	Operation selection of minimum turning angle or less
<p>Specify the operation when the turning angle is set the minimum turning angle (#1521 C_min) or less and the turning operation is not inserted, in the seams of the arc blocks during normal line control.</p> <p>0: Interpolate before reaching arc end point. 1: Do not interpolate.</p>			
	#12125	slide-F	Slide feedrate
<p>Specify the feedrate of slide movement.</p> <p>(Note 1) Slide movement is performed at rapid traverse. The feedrate is applied to all the axes. (Note 2) When "0" is set, 10% of the rapid traverse rate is applied. (Note 3) If the set speed exceeds the rapid traverse rate, it is clamped to the rapid traverse rate.</p> <p>---Setting range---</p> <p>0 to 1000000 (mm/min)</p>			
(PR)	#12126	Mcngit_Tch_M	Miscellaneous function code for tool exchange at machining interruption
<p>Specify the miscellaneous function code that is treated as the process start point in the tool exchange command.</p> <p>(Note) The following M codes cannot be used: M00, M01, M02, M30, M98, M99 and M198. If you set any of these, M06 is treated as the process start point.</p> <p>---Setting range---</p> <p>0 to 99999999</p>			
	#15001-15010	cfgsys01-cfgsys10	
<p>Not used. Set to "0".</p>			
(PR)	#15051-15060	cfgsysPR01-cfgsysPR10	
<p>Not used. Set to "0".</p>			

## 16.2 Base Axis Specification Parameters

(PR)	#1010	srvunit	Output unit (servo)
<p>Specify the unit for data communicated with the servo drive unit.            The data communicated between the NC and servo drive unit, and the servo movement data unit follow this specification.            The standard value is "D"; however, set the optimum value according to the machine model and specifications.</p> <p>B: 1 <math>\mu\text{m}</math>            C: 0.1 <math>\mu\text{m}</math>            D: 0.01 <math>\mu\text{m}</math> (10nm)            E: 0.001 <math>\mu\text{m}</math> (1nm)</p>			
(PR)	#1013	axname	Axis name
<p>Set each axis' name with an alphabetic character.            Use the characters X, Y, Z, U, V, W, A, B or C.            (Note 1) Do not set the same name twice in one part system.            The same name which is used in another part system can be set.            (Note 2) The PLC name does not need to be set. (Numbers 1 to 6 are shown as the axis names.)</p> <p><b>---Setting range---</b>            X,Y,Z,U,V,W,A,B,C</p>			
(PR)	#1014	incax	Incremental command axis name
<p>Set the axis name when commanding an incremental value for the axis travel amount.            (Note 1) Set an alphabet that is different from that of "#1013 axname".            (Note 2) There is no need to set this parameter when command type (absolute or incremental) is not distinguished by the axis address (when "#1076 AbsInc" = "0").</p> <p><b>---Setting range---</b>            X, Y, Z, U, V, W, A, B, C, H</p>			
(PR)	#1015	cunit	Program command unit
<p>Set the minimum increment of program travel command.            &lt;Travel amount for travel command 1&gt;            0: Follow "#1003 iunit"            1: 0.0001 mm (0.1 <math>\mu\text{m}</math>)            10: 0.001 mm (1 <math>\mu\text{m}</math>)            100: 0.01 mm (10 <math>\mu\text{m}</math>)            1000: 0.1 mm (100 <math>\mu\text{m}</math>)            10000: 1.0 mm</p> <p>If there is a decimal point in travel command, the decimal point position will be handled as 1 (mm) regardless of this setting.</p>			
(PR)	#1017	rot	Rotational axis
<p>Select whether the axis is a rotary axis or linear axis.            When rotary axis is set, the axis will be controlled with the rotary axis's coordinate system. Set the rotary axis type with "#8213 Rotation axis type".</p> <p>0: Linear axis            1: Rotary axis</p>			
(PR)	#1018	ccw	Motor CCW
<p>Select the direction of the motor rotation to the command direction.            0: Clockwise (looking from motor shaft) with the forward rotation command            1: Counterclockwise (looking from motor shaft) with the forward rotation command</p>			

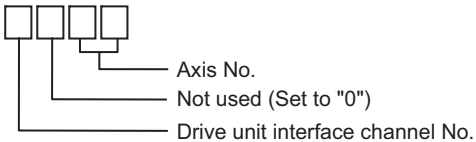

(PR)	#1019	dia	Diameter specification axis
<p>Select the command method of program travel amount.</p> <p>When the travel amount is commanded with the diameter dimensions, the travel distance will be 5mm when the command is 10mm of travel distance.</p> <p>The travel amount per pulse will also be halved during manual pulse feed.</p> <p>If diameter is selected, tool length, the wear compensation amount, and the workpiece coordinate offset will be displayed in diameter value. Other parameters concerning length will always be displayed in radius value.</p> <p>0: Command with travel amount 1: Command with diameter dimension</p>			
(PR)	#1020	sp_ax	Spindle interpolation
<p>Select "1" when using the spindle for contour control of NC axis (C-axis).</p> <p>0: Servo axis is used for contour control. 1: Spindle is used for contour control.</p>			
(PR)	#1021	mcp_no	Drive unit I/F channel No. (servo)
<p>Using a 4-digit number, set the drive unit interface channel No. and which axis in that channel is to be used when connecting a servo drive unit.</p>			
			
(PR)	#1022	axname2	2nd axis name
<p>Set the name of the axis displayed on the screen with two characters. (X1, Z2, etc.)</p> <p>Always use an alphabetic character (A to Z) for the first character.</p> <p>---Setting range---</p> <p>A to Z and 1 to 9 (Two digits) (Setting is cleared when "0" is set)</p>			
(PR)	#1023	crsadr	Command address during mixed control (cross axis control)
<p>Set the axis name for issuing a command to this axis during mixed control (cross axis control).</p> <p>---Setting range---</p> <p>A to Z (Setting is cleared when "0" is set)</p>			
(PR)	#1024	crsinc	Incremental command address during mixed control (cross axis control)
<p>Set the axis name for issuing an incremental command to this axis during mixed control (cross axis control).</p> <p>---Setting range---</p> <p>A to Z (Setting is cleared when "0" is set)</p>			
(PR)	#1061	intabs	Manual ABS updating
<p>Select whether to update the absolute position data during automatic handle interrupt.</p> <p>This parameter is enabled only when "#1145 I_abs" is set to "1".</p> <p>0: Do not update (coordinate system shifted the amount of the interruption) 1: Update (same coordinates as when interrupt did not occur will be applied)</p>			
	#1062	T_cmp	Tool compensation function
<p>Select whether the tool length compensation and wear compensation are enabled during T command execution.</p> <p>0: Tool length compensation enable      Wear compensation enable 1: Tool length compensation enable      Wear compensation disable 2: Tool length compensation disable      Wear compensation enable 3: Tool length compensation disable      Wear compensation disable</p>			

	<b>#1063</b>	<b>mandog</b>	<b>Manual dog-type</b>
			<p>Select the manual reference position return method for the second return (after the coordinate system is established) and later.</p> <p>The initial reference position return after the power ON is performed with dog-type return, and the coordinate system will be established.</p> <p>(This setting is not required when the absolute position detection is used.)</p> <p>0: High speed return 1: Dog-type</p>
<b>(PR)</b>	<b>#1064</b>	<b>svof</b>	<b>Error correction</b>
			<p>Select whether to correct the error when the servo is OFF.</p> <p>0: Not correct the error The command value will not change during servo OFF, and the movement amount during servo OFF will be handled as droop. When the servo is turned ON the next time, the axis will move to the command position where it used to be when the servo was turned OFF.</p> <p>1: Correct the error The command value and the current position will follow the feedback position. When the servo is turned ON the next time, the axis will not move.</p> <p>During servo READY OFF, the operation will be always the same as of "Correct the error". (The current position will follow the position of the axis.)</p>
<b>(PR)</b>	<b>#1068</b>	<b>slavno</b>	<b>Slave axis number</b>
			<p>Set the axis number of the slave axis in synchronous control.</p> <p>The axis number is an NC number excluding the spindle and PLC axis.</p> <p>Two or more slave axis cannot be set for one master axis.</p> <p>This parameter cannot be set for a slave axis.</p> <p>When using the multi-part system, the relation of the master axis and slave axis cannot extend over part systems.</p> <p>0: No slave axis 1 to 32: 1st to 32nd axis</p>
	<b>#1069</b>	<b>no_dsp</b>	<b>Axis with no counter display</b>
			<p>Select whether to display the axis counter or not.</p> <p>This setting is enabled on the counter display screen (relative position counter, etc.).</p> <p>0: Display 1: Not display</p>
	<b>#1070</b>	<b>axoff</b>	<b>Axis removal</b>
			<p>Select whether to enable or disable axis removal control.</p> <p>0: Disable 1: Enable</p>
	<b>#1072</b>	<b>chop_ax</b>	<b>Chopping axis</b>
			<p>Select the chopping axis.</p> <p>0: Non-chopping axis 1: Chopping axis</p>
<b>(PR)</b>	<b>#1493</b>	<b>ref_syn</b>	<b>Synchronization at zero point initialization</b>
			<p>0: Master axis and slave axis determine their zero points individually.</p> <p>1: The zero points of both master and slave axes are determined by initializing the master axis' zero point.</p> <p>The slave axis moves in perfect synchronization with the master axis. Set this to "1" for speed/current command synchronization control.</p>

<b>(PR)</b>	<b>#1494</b>	<b>dsp_ax_change</b>	<b>Axis order of counter display</b>
		<p>Set this in order to change the axis order of counter display.            If this is set, the axes will be displayed in ascending order.            However, axis whose setting is "0" will be displayed after axes whose settings are between "1" and "16" are displayed.</p> <p>(Note 1) When the same value is set for more than one axis, axis that is displayed on the left side on the parameter screen will be first displayed.            (Note 2) When both of the mixed control (cross axis control) and interchange coordinate position display ("1280 ext16/bit2" OFF) are valid, and when there are two or more valid part systems, this parameter will be ignored.            (Note 3) When the arbitrary axis exchange control (option) is ON, and when there are two or more valid part systems, this parameter will be ignored.</p> <p><b>---Setting range---</b></p> <p>0: The axis is displayed after the axes whose settings are between "1" and "16" are displayed.            1 to 16: Axes are displayed in ascending order.            If the number other than "1" to "16" is set, it is dealt as "0" setting.</p>	
<b>(PR)</b>	<b>#1495</b>	<b>grf_ax_direction</b>	<b>Axis travel direction in 2D graphic</b>
		Not used.	
<b>(PR)</b>	<b>#1496</b>	<b>push_typ</b>	<b>Stopper method in zero point establishing operation</b>
		<p>0: Zero point establishing operation is determined by #1493.            1: When both the master and slave axes reach the current limit during stopper-method zero point establishment with #1493 set to 1, droop is cancelled, and the operation goes into the next step.</p>	
<b>(PR)</b>	<b>#1601</b>	<b>axnameEx</b>	<b>Axis name extension letter</b>
		<p>Specify the second letter of command axis name when the axis name extension parameter is valid (#1266 ext02/bit0 = 1).            The command axis name is not extended if this parameter is unspecified, and the only one letter set in "#1013 axname" or "#1014 incax" respectively is the absolute command axis name or incremental command axis name.            Axis configuration should not be as the non-name extension axis (1-letter axis) after the name extension axis (2-letter axis) in the part system.            (Configure the 2-letter axis after the 1-letter axis)</p> <p><b>---Setting range---</b></p> <p>A to Z (Setting is cleared when "0" is set)</p>	
<b>(PR)</b>	<b>#1603</b>	<b>PLCdev_no</b>	<b>Axis device assignment No.</b>
		<p>Specify the PLC I/F device assignment No. for the axis.</p> <p><b>---Setting range---</b></p> <p>0: No designation for assignment            1 to 32: Axis device assignment No.</p>	
<b>(PR)</b>	<b>#1605</b>	<b>mgrnum</b>	<b>Machine group No.</b>
		<p>Specify the machine group No. to which each axis belongs.</p> <p><b>---Setting range---</b></p> <p>0 to 32</p>	

## 16.3 Base Common Parameters

	#1038	plcsel	Ladder selection
			Not used. Set to "0".
(PR)	#1039	spinno	Number of spindles
			Select the number of spindles. 0: No spindle 1 to 8: One to eight spindles
			(Note) The setting range differs according to the model.
(PR)	#1040	M_inch	Constant input (inch)
			Select the unit system for setting and display regarding machine parameter and PLC interface's position, length and speed. 0: Metric system 1: Inch system
(PR)	#1041	I_inch	Initial state (inch)
			Select the unit system for the program travel amount when the power is turned ON or reset and for position display. 0: Metric system 1: Inch system
			(Note) The units of the following data are converted by "#1041 I_inch". - Command unit at power ON and reset (Inch/metric command mode) But under the following conditions, the unit will follow G20/G21 command modal even at reset. When reset modal is retained ("#1151 rstint"="0") When G code group 06 reset modal is retained ("#1210 RstGmd/bit5" ON) - Unit system for position display (counter, user parameter, tool, work offset) - User parameter I/O unit - Parameter unit of user parameters concerning length and speed - Arc error parameter (#1084 RadErr)
(PR)	#1042	pcinch	PLC axis command (inch)
			Select the unit system for the commands to the PLC axis. 0: Metric system 1: Inch system

	<b>#1043</b>	<b>lang</b>	<b>Select language displayed</b>
			Select the display language.
			0: English
			1: Japanese
			11: German
			12: French
			13: Italian
			14: Spanish
			15: Traditional Chinese
			16: Korean
			17: Portuguese
			18: Dutch
			19: Swedish
			20: Hungarian
			21: Polish
			22: Simplified Chinese
			23: Russian
			24: Turkish
			25: Czech
<b>(PR)</b>	<b>#1044</b>	<b>auxno</b>	<b>MR-J2-CT Connections</b>
			Set the number of MR-J2-CTs connected.
			(Note) The number of MR-J2-CTs possible to connect and setting range are different according to the model. Check the specifications of each series.
<b>(PR)</b>	<b>#1045</b>	<b>nskno</b>	<b>Megatorque motor connections</b>
			Specify the number of NSK megatorque motors connected. When a value other than 0 is specified, 2nd miscellaneous function data is output as signed binary data.
			<b>---Setting range---</b>
			0 to 16
<b>(PR)</b>	<b>#1046</b>	<b>T-ofs disp type</b>	<b>Tool compensation display type switch (for M system only)</b>
			Not used.
<b>(PR)</b>	<b>#1047</b>	<b>G_Chg_En_Sno</b>	<b>Select program format switch-enabled part system</b>
			Not used.
<b>(PR)</b>	<b>#1051</b>	<b>MemTol</b>	<b>Tool compensation memory common for part systems</b>
			0: Tool compensation memory separate for part systems
			1: Tool compensation memory common for part systems

(PR)	#1052	MemVal	No. of common variables shared in part system designation
			0: Common variables common for part systems (number fixed) #100 -: Per part system #500 -: Common for part systems 1: Common variables common for part systems (number designation) #100 -: Designate with V1comN #500 -: Designate with V0comN  (Note 1) When this parameter is changed, the file system will be changed after the power is turned ON. So always execute format. The new format will be enabled after turning the power ON again. Setting order (1) MemVal changeover -> (2) Turn power ON again -> (3) Format -> (4) Turn power ON again (Note 2) When this parameter is set to "1", #900000 to #907399 are not available even if the number of common variables is 8000.
	#1077	radius	Incremental command for diameter specification axis
			Select whether the incremental command of the diameter specification axis ("#1019 dia" is set to "1") uses the diameter value or radius value. 0: Diameter value 1: Radius value
	#1078	Decpt2	Decimal point type 2
			Select the increment of position commands that do not have a decimal point. 0: Minimum input command unit (follows "#1015 cunit") 1: 1mm (or 1inch) unit (For the dwell time, 1s unit is used.)
	#1079	F1digit	Validate F1 digit
			Select the F command method. 0: Direct numerical command (command feedrate during feed per minute or rotation) 1: 1-digit code command (feedrate set with "#1185 spd_F1" to "#1189 spd_F5")
	#1080	Dril_Z	Drilling Z fixed
			Select a fixed cycle hole drilling axis. 0: Use an axis vertical to the selected plane as hole drilling axis. 1: Use the Z axis as the hole drilling axis regardless of the selected plane.
	#1081	Gmac_P	Give priority to G code parameter
			Select the G code priority relationship during the macro call with G command. 0: Priority is on G code used in the system 1: Priority is on registered G code for call
	#1082	Geomet	Geometric
			Select the type of geometric to use. 0: Not use 1: Use only geometric I 2: Use geometric I and IB  With geometric, specific address codes are used for exclusive meanings. Thus, if A or C is used for the axis name or 2nd miscellaneous command code, the A used for the axis name may function as the geometric's angle designation. Pay special attention to axis names, etc., when using this function.
	#1084	RadErr	Arc error
			Set the tolerable error range when the end point deviates from the center coordinate in the circular command. <b>---Setting range---</b> 0 to 1.000 (mm)

#1087	G96_G0	Constant surface speed control by rapid traverse feed command	
		Select how to handle the surface speed for the G00 command when using the constant surface speed control function. 0: Calculate the surface speed constantly even during G00 movement 1: Calculate the surface speed at the block end point in the G00 command	
#1088	G30SL	Disable G30 soft limit	
		Select how to handle the soft limit during G30 (2nd reference position return). 0: Enable 1: Disable	
#1091	Mpoint	Ignore middle point	
		Select how to handle the middle point during G28 and G30 reference position return. 0: Pass the middle point designated in the program and move to the reference position. 1: Ignore the middle point designated in the program and move straight to the reference position.	
#1092	Tchg_A	Replace tools for additional axis	
		Select the movement of the additional axis at the tool change position return command. 0: The additional axis will not move 1: After the standard axis returns, the additional axis will also return to the tool change position	
#1093	Wmvfin	Synchronization between part systems method	
		Select the timing of synchronization between part systems when using the multi-part system. When the travel command is found in the synchronization command (I, M) block: 0: Synchronize before executing travel command 1: Synchronize after executing travel command	
#1094	TI_SBK	Select life count for single block (for L system only)	
		Select whether to count the data units to be used for single block operation when using the tool life management II function (L system). 0: Not count 1: Count	
#1095	T0tfof	TF output (for L system only)	
		Select how to handle TF for T00 command. 0: TF will be output 1: TF wont be output	
(PR)	#1096	T_Ltyp	Tool life management type
		Select the tool life management type. 1: Life management I The cutting hours or number of cuttings of the tool that is commanded in the program is accumulated to monitor the usage state. 2: Life management II The same as tool life management I, but with the spare tool selection function. A spare tool is selected from a group of tool commands commanded in the program. Tool compensations (tool length and radius compensations) are carried out for the selected tool. 3: Life management III (for M system only) The cutting hours or number of cuttings of the tool that is commanded in the program is accumulated to monitor the usage state. The group No. is not used to manage the tool life. (Note) When "3" is set for the L system, the tool life management I is selected.	

#1097	Tldigt	Tool offset No. digits selection
		Select the number of digits for an offset No. in command T. 0: Lower two digits of command T serve as an offset No.; the remaining upper digits as a tool No. 1: Lower one digit of command T serves as an offset No.; the remaining upper digits as a tool No. 2: Lower two digits of command T serve as an offset No., the remaining upper digits as a tool No. 3: Lower three digits of command T serve as an offset No.; the remaining upper digits as a tool No.
#1098	Tlno.	Tool length offset number
		Select the number of digits of the tool length compensation No. in the T command. 0: Lower 3 digits in T code serve as a tool length and wear offset Nos.; the remaining upper digits as a tool No. 1: Lower 3 digits in T code serve as a tool wear offset No.; the remaining upper digits as a tool No. and tool length offset No.
#1099	Treset	Cancel tool compensation amount
		Select how to handle the tool compensation vector when resetting the system. 0: Clear the tool length and wear compensation vectors when resetting 1: Hold the tool length and wear compensation vectors when resetting  When the values are cleared, the compensation will not be applied. So the axis will be shifted by the compensation amount in the next compensation operation. When the values are kept, the compensation will be applied, so the axis will shift the differential amount of the compensation amount in the next compensation operation.
#1100	Tmove	Tool compensation
		Select when to perform tool length compensation and wear compensation. 0: Compensate when T command is executed. 1: Superimpose and compensate with the travel command in the block where the T command is located. If there is no travel command in the same block, compensation will be executed after the travel command is superimposed in the next travel command block. 2: Compensate the wear amount when the T command is executed. Superimpose and compensate the tool length compensation amount with the travel command in the same block. If there is no travel command in the same block, compensation will be executed after the travel command is superimposed in the next travel command block.
#1101	Tabsmv	Tool compensation method
		Select the type of travel command when "#1100 Tmove" is set to "1" or "2". 0: Compensate regardless of the travel command type (absolute or incremental) 1: Compensate only at the travel command in the absolute command
#1103	T_Life	Validate life management
		Select whether to use the tool life management. 0: Not use tool life management. 1: Use tool life management.
#1104	T_Com2	Tool command method 2
		Select how to handle the tool command in the program when "#1103 T_Life" is set to "1". 0: Handle the command as group No. 1: Handle the command as tool No.  (Note) In the case of the tool life management III, the program tool command will be handled as the tool No. regardless of the setting.
#1105	T_sel2	Tool selection method 2
		Select the tool selection method when "#1103 T_Life" is set to "1". 0: Select in order of registered No. from the tools used in the same group. 1: Select the tool with the longest remaining life from the tools used or unused in the same group.



	<b>#1106</b>	<b>Tcount</b>	<b>Life management (for L system only)</b>
			Select the input method when address N is omitted in inputting the data (G10 L3 command) for tool life management function II. 0: Time specified input 1: Number of times specified input
	<b>#1107</b>	<b>Tlifsc</b>	<b>Split life management display screen (for L system only)</b>
			Set the number of groups to be displayed on the tool life management II (L system) screen. 0: Displayed group count 1, maximum number of registered tools: 16 1: Displayed group count 2, maximum number of registered tools: 8 2: Displayed group count 4, maximum number of registered tools: 4
	<b>#1108</b>	<b>TirectM</b>	<b>Life management re-count M code (for L system only)</b>
			Set the M code for tool life management II (L system) re-count. ---Setting range--- 0 to 99
<b>(PR)</b>	<b>#1112</b>	<b>S_TRG</b>	<b>Validate status trigger method</b>
			Select the enable conditions for the user macro interrupt signal (UIT). 0: Enable when interrupt signal (UIT) turns ON 1: Enable when interrupt signal (UIT) is ON
<b>(PR)</b>	<b>#1113</b>	<b>INT_2</b>	<b>Validate interrupt method type 2</b>
			Select the performance after user macro interrupt signal (UIT) input. 0: Execute interrupt program without waiting for block being executed to end 1: Execute interrupt program after completing block being executed
	<b>#1114</b>	<b>mcrint</b>	<b>Macro argument initialization</b>
			Select whether to clear statements other than specified arguments by macro call. Also select whether to clear local variables by power-ON and resetting. 0: Clear the non-specified arguments by macro call. 1: Hold non-specified arguments by macro call 2: Hold non-specified arguments by macro call, and clear local variables by power-ON and resetting
	<b>#1115</b>	<b>thwait</b>	<b>Waiting for retract</b>
			Set the number of waits for retract when chamfering is OFF in thread cutting. ---Setting range--- 0 to 99 (Approx. 4 ms) Standard setting value: 4
	<b>#1116</b>	<b>G30SLM</b>	<b>Invalidate soft limit (manual operation)</b>
			Enable this function when disabling the soft limit check function at the second to fourth reference position return. 0: Enable soft limit function 1: Disable soft limit function
<b>(PR)</b>	<b>#1117</b>	<b>H_sens</b>	
			Not used.
	<b>#1118</b>	<b>mirr_A</b>	<b>Select how to set up the length of tools on cutter tables (opposed tables) (for L system only)</b>
			Select one of the following two methods: - Set the current length of tools on each facing turret. - Set a value, assuming that the tools on each facing turret are in the same direction as that of those on the base turret. 0: Current length of the tools on each facing turret 1: Value, assuming that the tools on each facing turret are in the same direction as that of those on the base turret

	<b>#1119</b>	<b>Tmiron</b>	<b>Select the mirror image of each facing turret with T command (for L system only)</b>
			Select whether to enable the mirror image of each facing turret with the T command. 0: Disable 1: Enable
<b>(PR)</b>	<b>#1120</b>	<b>TofVal</b>	<b>Change macro variable</b>
			Select whether to change the macro variable (tool offset) numbers for shape compensation and wear compensation. 0: Not change (Conventional specification) 1: Change the shape and wear compensation variable numbers each for X, Z, and R
	<b>#1121</b>	<b>edlk_c</b>	<b>Edit lock C</b>
			Select the edit lock for program Nos. 9000 to 9999 in memory. 0: Editing possible 1: Editing prohibited. The file cannot be opened.
			(Note) If "#1122" is set to "1" or "2", "1" will be set in "#1121" when the power is turned ON.
<b>(PR)</b>	<b>#1122</b>	<b>pglk_c</b>	<b>Program display lock C</b>
			Select whether to prohibit the program display and search for program Nos. 9000 to 9999 in memory. 0: Program display and search is possible 1: Program display is impossible. Search is possible. 2: Program display and search is impossible The program details will not be displayed, but the program No. and sequence No. will display in the prohibited state.
			(Note) If "#1122" is set to "1" or "2", "1" will be set in "#1121" when the power is turned ON.
	<b>#1123</b>	<b>origin</b>	<b>Origin set prohibit</b>
			Select whether to use the origin set function. 0: Use 1: Not use
	<b>#1124</b>	<b>ofsfix</b>	<b>Fix tool compensation No.</b>
			Select how to handle the compensation No. when the input key is pressed on the tool compensation screen. 0: Increment the compensation No. by 1 (Same as general parameters) 1: # compensation No. does not change
			When setting in sequence, "0" is handier. When changing and setting repeatedly while adjusting one compensation value, "1" is handier.
	<b>#1125</b>	<b>real_f</b>	<b>Actual feedrate display</b>
			Select the feedrate display on the monitor screen. 0: Command speed 1: Actual travel feedrate
	<b>#1126</b>	<b>PB_G90</b>	<b>Playback G90</b>
			Select the method to command the playback travel amount in the playback editing. 0: Incremental value 1: Absolute value
	<b>#1127</b>	<b>DPRINT</b>	<b>DPRINT alignment</b>
			Select the alignment for printing out with the DPRINT function. 0: No alignment, output s printed with left justification 1: Align the minimum digit and output

<b>#1128</b>	<b>RstVCI</b>	<b>Clear variables by resetting</b>
Select how to handle the common variables when resetting.		
0: Common variables won't change after resetting.		
1: Common variables will be cleared #100 to #199 by resetting.		
<b>#1129</b>	<b>PwrVCI</b>	<b>Clear variables by power-ON</b>
Select how to handle the common variables when the power is turned ON.		
0: The common variables are in the same state as before turning the power OFF.		
1: Common variables will be cleared #100 to #199 when the power is turned ON.		
<b>#1130</b>	<b>set_t</b>	<b>Display selected tool number</b>
Select the tool command value display on the monitor screen.		
0: Display T-modal value of program command		
1: Display Tool No. sent from PLC		
<b>#1132</b>	<b>brightness</b>	<b>Brightness control</b>
Select the brightness of display unit.		
1: High brightness (in bright state)		
0: Medium brightness		
-1: Low brightness (in dim state)		
<b>#1133</b>	<b>ofsmem</b>	
Not used. Set to "0".		
<b>#1134</b>	<b>LCDneg</b>	
Not used. Set to "0".		
<b>#1135</b>	<b>unt_nm</b>	<b>Unit name</b>
Set the unit name.		
Use 4 or less characters consisting of both alphabets and numbers.		
If "0" is set, the unit name won't be displayed.		
<b>---Setting range---</b>		
4 or less characters consisting of both alphabets and numbers		
<b>#1136</b>	<b>optype</b>	
Not used. Set to "0".		
<b>#1137</b>	<b>Cntsel</b>	
Not used. Set to "0".		
<b>#1138</b>	<b>Pnosel</b>	
Not used. Set to "0".		
<b>#1139</b>	<b>edtype</b>	
Not used. Set to "0".		
<b>#1140</b>	<b>Mn100</b>	<b>M code number</b>
Set the first number of M code that corresponds to the setup Nos. from 100 to 199.		
<b>---Setting range---</b>		
0 to 99999999		
<b>#1141</b>	<b>Mn200</b>	<b>M code number</b>
Set the first number of M code that corresponds to the setup Nos. from 200 to 299.		
<b>---Setting range---</b>		
0 to 99999999		
<b>#1142</b>	<b>Mn300</b>	<b>M code number</b>
Set the first number of M code that corresponds to the setup Nos. from 300 to 399.		
<b>---Setting range---</b>		
0 to 99999999		

#1143	<b>Mn400</b>	<b>M code number</b>
	Set the first number of M code that corresponds to the setup Nos. from 400 to 499.	
	<b>---Setting range---</b>	
	0 to 99999999	
#1144	<b>mdlkof</b>	<b>MDI setup lock</b>
	Select whether to enable MDI setting in non-MDI mode.	
	0: Disable MDI setting	
	1: Enable MDI setting	
#1145	<b>I_abs</b>	<b>Manual ABS parameter</b>
	Select how to handle the absolute position data during automatic handle interrupt.	
	0: Absolute position data will be renewed if manual ABS switch is ON. If it is OFF, data won't be renewed.	
	1: Follow the "intabs" state when "#1061 intabs" is enabled	
#1146	<b>Sclamp</b>	<b>Spindle rotation speed clamp function</b>
	Select how to handle the spindle rotation speed clamp function with the G92/G50S command.	
	0: G92/G50S command is handled as a clamp command only in the G96 state (during constant surface speed control).	
	G92S will be handled as normal S command in G97 state (constant surface speed OFF).	
	1: The S command in the same block as G92/G50 is constantly handled as a clamp command	
#1147	<b>smin_V</b>	<b>Minimum spindle rotation speed clamp type</b>
	Specify the type of spindle min. rotation speed clamp value.	
	0: Rotation speed setting	
	1: Output voltage coefficient setting	
	Set "#3023 smini" according to this type setting.	
#1149	<b>cireft</b>	<b>Arc deceleration speed change</b>
	Select whether to decelerate at the arc entrance or exit.	
	0: Not decelerate	
	1: Decelerate	
#1153	<b>FixbDc</b>	<b>Hole bottom deceleration check</b>
	Select whether to perform a deceleration check or in-position check at the hole bottom in a hole drilling cycle. This parameter is enabled only for a hole drilling cycle in which no dwell command can be issued at the hole bottom.	
	0: Perform no deceleration check and in-position check	
	1: Perform deceleration check	
	2: Perform in-position check	
(PR)	#1154	<b>pdoor</b>
	Not used. Set to "0".	
	#1155	<b>DOOR_m</b>
	Not used. Set to "100".	
	#1156	<b>DOOR_s</b>
	Not used. Set to "100".	
	#1157	<b>F0atrn</b>
	Not used. Set to "0".	
	#1158	<b>F0atno</b>
	Not used. Set to "0".	

<b>(PR)</b>	<b>#1163</b>	<b>No rio</b>	<b>RIO connection detection invalid</b>
			Select whether to enable or disable RIO connection detection. 0: Enable 1: Disable If your I/O consists of only cards such as CC-LINK, setting this parameter to "1" will avoid the RIO communication cutoff alarm.
<b>(PR)</b>	<b>#1164</b>	<b>ATS</b>	<b>Automatic tuning function</b>
			Select whether to enable or disable the automatic tuning function. 0: Disable 1: Enable (Note 1) Enable this parameter when using MS Configurator. (Note 2) Disable this parameter during normal operation. (Note 3) Search & start function is disabled for safety when this parameter is set to "1".
	<b>#1166</b>	<b>fixpro</b>	<b>Fixed cycle editing</b>
			Select the type of programs handle on the Edit/Program list/Data in/out screen from the following: general programs, fixed cycles, or machine tool builder macro programs. 0: General programs can be edited, etc. 1: Fixed cycles can be edited, etc. Password No.: The machine tool builder macro programs can be edited, etc. <b>---Setting range---</b> 0 to 99999999
	<b>#1167</b>	<b>e2rom</b>	
			Not used. Set to "0".
	<b>#1168</b>	<b>test</b>	<b>Simulation test</b>
			Select the test mode for the control unit. In the test mode, test is performed with a hypothetical reference position return complete even though the real reference position return hasn't been completed. This is limited to test operation of the control unit itself, and must not be used when the machine is connected. 0: Normal operation mode 1: Test mode
	<b>#1217</b>	<b>aux01</b>	
			Not used. Set to "0".

#1218

aux02

---

**bit3: Parameter input/output format**

Select the parameter input/output format.

0: Type I

Displayed on one line per parameter.

(Example)

N1001T1P1

N1001T2P1

N1001T3P0

1: Type II

Data with the same parameter number is displayed on the same line.

(Example)

N1001 T1 P1 T2 P1 T3 P0

**bit4: External workpiece coordinate offset tool number selection**

Select the R register that contains the tool number used for automatic calculation when measuring the coordinate offset of an external workpiece.

0: Follow the setting of "#1130 set\_t".

1: Use the tool number indicated by user PLC.

**bit5: Parameter I/O II spindle specification address**

Select the spindle specification address of parameter I/O type II.

0: C

1: T

This parameter is also applied to the spindle specification address for input and verification.

(Note) This parameter is valid only for parameter I/O type II (when "#1218 aux02/bit3" is set to "1").

#1219 aux03

**bit1: Stop high-speed PC monitoring function**

Set "1" to disable the function that triggers the emergency stop when the PC high-speed processing time is extended.

Disable the monitoring function only as a temporary measure.

**bit5: Dog-type intermediate point**

Select whether to move to the intermediate point during automatic dog-type reference position return.

0: Not move.

1: Move.

**bit7: Time constant setting changeover for soft acceleration/deceleration**

0: Accelerating time is  $G0tL(G1tL)$ .

When the G00 pre-interpolation acceleration/deceleration and the soft acceleration/deceleration are used together, the inclination of soft acceleration/deceleration will be steeper by setting a time to the soft acceleration/deceleration 2nd step time constant (#2005 G0t1). Consequently, the acceleration for G28/G30 will be larger than that for G00.

(1) Total accelerating time is "G0tL".

(2) The time for curve part is "G0t1".

(3) The time for linear part is obtained by " $G0tL - (2 \times G0t1)$ ".

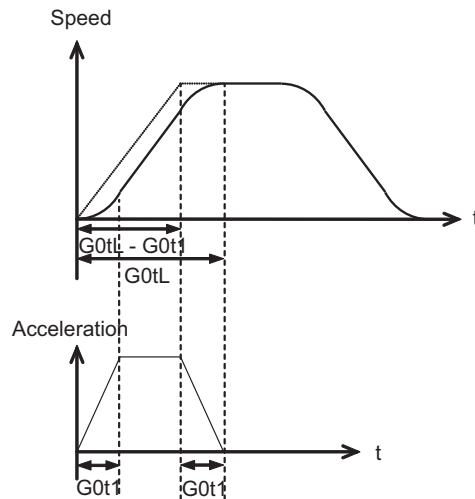

1: Accelerating time is obtained by  $G0tL + G0t1 (G1tL + G1t1)$ .

When the G00 pre-interpolation acceleration/deceleration and the soft acceleration/deceleration are used together, you can attain the G28/G30 acceleration that is equal to G00, by setting the same value to G00 soft acceleration/deceleration filter (#1569 SfiltG0) as well as to the soft acceleration/deceleration 2nd step time constant (#2005 G0t1).

(1) Total accelerating time is obtained by " $G0tL + G0t1$ ".

(2) The time for curve part is "G0t1".

(3) The time for linear part is obtained by " $G0tL - G0t1$ ".

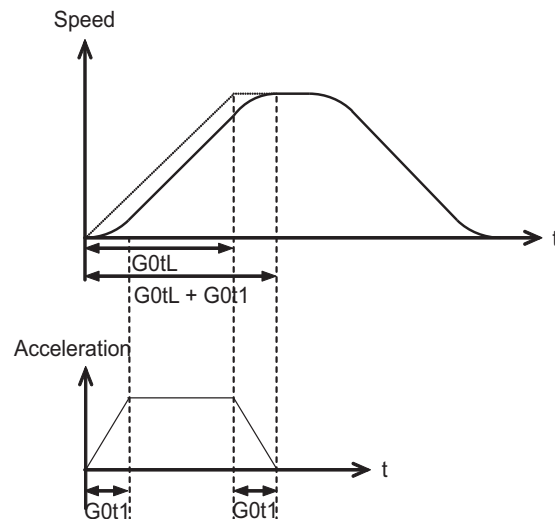

#1220	aux04	(for L system only)
<b>bit0: Tool life check timing selection</b>		
Select the criterion to judge the end of tool life when the cumulative number of cuttings is incremented in tool life management II.		
0: Determine the tool life end when the incremented cumulative number of cuttings has exceeded the estimated number of cuttings. (Default) (cumulative number of cuttings > estimated number of cuttings)		
1: Determine the tool life end when the incremented cumulative number of cuttings has reached the estimated number of cuttings. (cumulative number of cuttings >= estimated number of cuttings)		
#1221	aux05	
<b>bit0: Workpiece coordinate/absolute coordinate display switch</b>		
Select whether to display the workpiece coordinate or to display the absolute coordinate in the coordinate value screen, command value screen or modal information screen.		
0: Workpiece coordinate		
1: Absolute coordinate		
#1222	aux06	
<b>bit4: Minimum cut-in amount selection</b>		
Select the minimum cut-in amount command value for the compound thread cutting cycle (G76 command).		
0: The minimum cut-in amount (Q) will be "0".		
1: The minimum cut-in amount (Q) will be set in the last command value (it is retained even after the NC power has been turned off).		
<b>bit5: Fixed cycle for compound lathe command format check selection</b>		
Select the operation when the 1st block of the fixed cycle for compound lathe is omitted while the conventional format is selected ("#1265 ext01/bit0" is set to "0").		
0: Program error (P33) will occur.		
1: Parameter setting value will be used.		
<b>bit7: Reference position return deceleration check method</b>		
Select the deceleration check method to be used during automatic reference position return.		
0: In-position check		
1: Commanded deceleration check		



#1223

aux07

**bit1: Deceleration check method 2**

Select the deceleration check method in G1+G9.

- 0: Command deceleration check in G1+G9
- 1: In-position check in G1+G9

The deceleration check is not performed for the commands except G1+G9.

When "#1306 InpsTyp deceleration check specification type" is set to "1" (Deceleration check specification type 2), this parameter will be invalid.

**bit2: Synchronous tap R-point in-position check**

Select whether to enable the synchronous tap I-point -> R-point in-position check.

- 0: Disable
- 1: Enable

(Note) This parameter is valid only when "1" (Enable in-position check) is set for "#1223 aux07/bit3 Synchronous tap in-position check improvement".

**bit3: Synchronous tap in-position check improvement**

Select whether to enable the synchronous tap in-position check improvement.

- 0: Disable
- 1: Enable

Related parameters:

- #1223/bit2 Synchronous tap R-point in-position check
- #1223/bit4 Synchronous tap hole bottom in-position check
- #1223/bit5 Synchronous tap R-point in-position check 2

**bit4: Synchronous tap hole bottom in-position check**

Select whether to enable the synchronous tap hole bottom in-position check.

- 0: Disable
- 1: Enable

(Note) This parameter is valid only when "1" (Enable in-position check) is set for "#1223 aux07/bit3 Synchronous tap in-position check improvement".

**bit5: Synchronous tap R-point in-position check 2**

Select whether to enable the synchronous tap R-point in-position check.

- 0: Disable
- 1: Enable

(Note) This parameter is valid only when "1" (Enable in-position check) is set for "#1223 aux07/bit3 Synchronous tap in-position check improvement".

**bit6: Cancel synchronous tap (, S) return**

- 0: Retain the spindle speed (,S) in synchronous tap return
- 1: Cancel the spindle speed (,S) in synchronous tap return with G80

**bit7: Synchronous tap method**

Specify a synchronous tap method.

- 0: Synchronous tap with multi-step acceleration deceleration
- 1: Conventional type synchronous tap

---

**#1224**      **aux08**

---

**bit0: Sampling data output**

Select whether to enable the sampling data output.

- 0: Disable
  - 1: Enable
- 

**#1225**      **aux09**

---

**bit7: Enable/disable spindle rotation speed clamp**

Select whether to enable the spindle rotation speed clamp by the G92 S or Q command for the spindle command rotation speed (R7000) set with the user ladder.

- 0: Enable
  - 1: Disable
- 

**#1226**      **aux10**

---

**bit0: Tool compensation data for external workpiece coordinate offset measurement**

Select the tool compensation data to be used for external workpiece coordinate offset measurement.

- 0: Tool length data and tool nose wear data
- 1: Tool length data

**bit1: Optional block skip type**

Select whether to enable the optional block skip in the middle of a block.

- 0: Enable only at the beginning of a block.
- 1: Enable in the middle of a block, as well as at the beginning of the block.

Note that a slash "/" in an equation between [ ] is handled as division operator.

(Note) This parameter is enabled when "#1274 ext10/bit4" is "0".

**bit2: Single block stop timing**

Select the timing at which the "Single block" signal is activated.

- 0: When the signal goes ON while automatic operation is starting, the block will stop after finished.
- 1: When the signal is ON at the end of the block, the block will stop.

**bit3: C-axis reference position return type**

Select the C-axis reference position return type.

- 0: Basic position return is performed by the G28 reference position return command or by activating the manual reference position return. The basic point dog is used.
- 1: When the first C-axis command is issued after the C-axis mode is entered in automatic mode, reference position return is performed before the execution of the block. The reference position return is also performed by the G28 reference position return command or by activating the manual reference position return. The Z phase of the encoder is used.

**bit4: S command during constant surface speed**

Select whether to output a strobe signal when the S command is issued in constant surface speed mode.

- 0: Not output any strobe signal in constant surface speed mode.
- 1: Output strobe signals in constant surface speed mode.

**bit5: Arbitrary allocation of dog signal**

Select whether to enable the arbitrary allocation parameter for "Reference position return near-point detection" signal and "Stroke end" signal.

- 0: Disable (Fixed device is used.)
- 1: Enable (Device is specified by the parameter.)

**bit7: Shorten JOG stop time**

Specify whether to shorten the JOG stop time.

- 0: Do not shorten the JOG stop time. (Same as before)
- 1: Shorten the JOG stop time.

#1227

aux11

---

**bit0: Select PLC signal or spindle feedrate attained**

Set up this option when disabling the cutting start interlock by spindle feedrate attained.

- 0: Cutting start interlock by PLC signal
- 1: Cutting start interlock by spindle feedrate attained

**bit1: Select H or D code**

Set up this option to validate the data that is set up on the tool life management screen when issuing the H99 or D99 command.

- 0: The H and D codes validate the data that is set up on the management setup screen.
- 1: Validates the data that is set up on the management setup screen when issuing the H99 or D99 command.

**bit2: Measures against tool setter chattering**

Select a condition where a relieving operation completes after measurement with tools.

- 0: Sensor signals have stopped for 500 (ms) or longer.
- 1: 100 ( $\mu\text{m}$ ) or longer has passed after sensor signals stopped.

**bit4: Word command check**

Select whether to output an error when no numeric value follows a program address during execution of a machining program.

- 0: Not check
- 1: Check

**bit5: Spindle rotation speed clamp**

Specify whether to clamp the rotation speed in constant surface speed mode when the spindle rotation clamp command is issued.

- 0: Clamps the rotation regardless of the constant surface speed mode.
- 1: Clamps the rotation only in constant surface speed mode.

**bit7: Switch the range of tool life data to be input**

Set up the range of tool life data to be input or compared.

- 0: Inputs or compares all of the data output.
- 1: Inputs or compares part of the data output
  - (1) Tool life management I data to be input or compared  
Tool number (D), lifetime (E), life count (F), and auxiliary data (B).
  - (2) Tool life management II data to be input or compared  
Group number (G), method (M), life (E/F), tool number (D), and compensation number (H)

#1228

aux12

---

**bit0:**

When not using, set to "0".

**bit1: Switch "offset and parameter" screen**

Select to switch the "offset and parameter" screen to the parameter screen.

0: Display the "offset and parameter" screen.

1: Display the "parameter" screen.

**bit2:**

Not used.

**bit3: Nose R specification**

Select whether to specify the nose R compensation by shape or wear number.

0: Specifies the nose R compensation by shape number.

1: Specifies the nose R compensation by wear number.

**bit4: Select operation error or stop code**

Select operation error or stop code to provide for both block start and cutting start interlocks.

0: Operation error

1: Stop code

**bit5: Select constant surface speed coordinates**

Select the constant surface speed coordinate.

0: Workpiece coordinate

1: Absolute value coordinate

**bit6: Switch relative values displayed**

Select whether to preset the relative coordinates with workpiece coordinate preset (G92.1) or counter preset (G92).

0: Preset the relative coordinates.

1: Not preset the relative coordinates.

**bit7: Protection with manual value command**

Select whether to protect a manual value command.

0: Not protect. (Conventional specification)

1: Protect.

---

**#1229 set01**

---

**bit0: Subprogram interrupt**

Select the type of the user macro interrupt.

- 0: Macro type user macro interrupt
- 1: Sub-program type user macro interrupt

**bit1: Accurate thread cutting E**

Select what the address E specifies in inch screw cutting.

- 0: Number of threads per inch
- 1: Precision lead

**bit2: Radius compensation type B (for M system only)**

Select the method of the arithmetic processing for the intersection point when the start-up or cancel command is operated during radius compensation.

- 0: The processing does not handle the start-up or cancel command block: handle the offset vector in the direction vertical to that of the command instead.
- 1: The processing is executed for the intersection point between the command block and the next block.

**bit2: Nose R compensation type B (for L system only)**

Select the method of the arithmetic processing for the intersection point when the start-up or cancel commands are operated during nose R or radius compensation.

- 0: The processing does not handle the start-up or cancel command block: handle the offset vector in the direction vertical to that of the command instead.
- 1: The processing is executed for the intersection point between the command block and the next block.

**bit3: Initial constant surface speed**

Select the initial state after the power-ON.

- 0: Constant surface speed control cancel mode
- 1: Constant surface speed control mode

**bit4: Synchronous tap**

Select the operation when ",R" is omitted in G74/G84 tapping cycle.

- 0: Asynchronous tap
- 1: Synchronous tap

**bit5: Start point alarm**

Select the operation when the operation start point cannot be found while executing the next block of G115, G116 or G117.

- 0: (G115/G116)Starts after the block has been moved.  
(G117)Enables an auxiliary function after the block has been moved.
- 1: (G115)Waits until reaching start point at the movement after next block when the operation start point is not found.  
(G116/G117)Outputs an program error (P33) when the operation start point is not found.

**bit6: Grid display selection**

Select the grid display type on the servo monitor screen during the dog type reference position return.

- 0: Distance between dog OFF and basic point (including a grid mask amount)
  - 1: A value given by reducing a grid mask amount from the distance between dog OFF and basic point
- 

**#1230 set02**

---

**bit2: Proximity switch spindle orientation: Z phase re-detection request type**

Select when to request Z phase re-detection for proximity switch type spindle orientation.

- 0: After confirming the spindle has reached the Z phase detection speed.
- 1: Right after Servo ON of the spindle.

**bit7: Macro interface input/output for each part system**

Select the specification of the macro interface input/output.

- 0: Shared by all part systems.
- 1: Used independently by the part systems.

<b>#1231</b>	<b>set03</b>
Not used. Set to "0".	
<b>#1232</b>	<b>set04</b>
<b>bit0: Exclude acceleration/deceleration in load monitor</b>	
Not used. Set to "0".	
<b>bit5: Actual load selection</b>	
Load fluctuation due to speed change is excluded from the actual load.	
0: Disable	
1: Enable	
(Note) When "Actual load selection" ("#1232 set04/bit5") is enabled, "Spindle function 8" ("#13228 SP228/bit2") needs to be set to "1" (load display, high-cycle motor output effective value).	
<b>#1233</b>	<b>set05</b>
When not using, set to "0".	
<b>#1234</b>	<b>set06</b>
<b>bit3: Interlock when tap retract enabled</b>	
Select whether to enable automatic/manual interlock for the part system with "Tap retract enable" signal ON.	
0: Interlock all the axes	
1: Disable the interlock	
<b>#1235</b>	<b>set07</b>
<b>bit0: Helical interpolation speed 2</b>	
0: Select normal speed designation also for 3rd axis	
1: Select arc plane element speed designation	
<b>bit2: Fixed type chopping compensation valid only at start</b>	
When the fixed type compensation value is selected, the method can be changed to the compensation value sequential update type after the first four cycles.	
0: Disable the method changeover	
1: Enable the method changeover	
<b>bit4: Selection condition of synchronous tapping gear step</b>	
Select the parameters that determine the gear step for synchronous tapping.	
0: #3005 through #3008 (smax1 to 4) when "#1223 aux07/bit7" is "0".	
Or #3013 through #3016 (stap1 to 4) when "#1223 aux07/bit7" is "1".	
1: Always #3013 through #3016 (stap1 to 4)	

#1236	set08
	<p><b>bit0: Manual rotary axis feedrate unit</b></p> <p>Select the unit of manual rotary axis feedrate.</p> <p>0: Fixed to [°/min]</p> <p>1: Same speed as before (When inch command, the speed is the command speed divided by 25.4.)</p> <p><b>bit1: Spindle speed detection</b></p> <p>Select the pulse input source of actual spindle rotation speed (R6506/R6507) when the spindle encoder serial connection is selected ("#3025 enc-on" is set to "2").</p> <p>0: Serial input</p> <p>1: Encoder input connector</p> <p><b>bit2: Current limit droop cancel invalid</b></p> <p>Select whether to cancel the position droop when the current limit changeover signal is canceled.</p> <p>0: Cancel the droop.</p> <p>1: Not cancel the droop.</p> <p><b>bit3: Rotary axis command speed scale</b></p> <p>Select to multiply the rotary axis command speed by 10 times.</p> <p>0: Invalid</p> <p>1: During initial inching, the rotary axis command speed is multiplied by 10. In other words, if "F100" is commanded, the speed will be the same as when 1000°/min is commanded. The rotary axis speed display unit will be 10°/min.</p>
(PR) #1237	set09
	Not used. Set to "0".

---

(PR) #1238 set10

---

**bit0: Switch G36 function**

Not used. Set to "0".

**bit3: Ignoring input from RIO**

Select whether to ignore the input from RIO.

0: Output the input from RIO to the device X.

1: Ignore the input from RIO, and not output it to X device.

(X000 to X0FF, X100 to X1FF and X200 to X2BF)

\* Normally set this parameter to "0".

\* The devices X2C0 to X2FF are used for the handle pulse input and board reset from the operation panel I/O unit card (HN391/HN392), thus are excluded from the target.

**bit6: Switch absolute position detection alarm**

Select the output destination of the absolute position detection alarm.

0: NC alarm 4 (AL4)

1: NC alarm 5 (AL5)

(Note) The absolute position detection alarm is listed in the alarm history regardless of this parameter setting.

**bit7: Switch operation alarm**

Select whether to enable the NC alarm 5 (AL5) signal output.

0: Disable NC alarm 5 (AL5)

All operation alarms will be output to NC alarm 4 (AL4).

1: Enable NC alarm 5 (AL5)

The following operation alarms will be output to NC alarm 5 (AL5), not to NC alarm 4 (AL4).

- ◆External interlock axis exists (M01 0004)
- ◆Cutting override zero (M01 0102)
- ◆External feedrate zero (M01 0103)
- ◆Block start interlock (M01 0109)
- ◆Cutting block start interlock (M01 0110)
- ◆Interference check disabled (M01 0200)
- ◆Cutting interlock for spindle-spindle polygon (G51.2) (M01 1033)

The above alarms are not recorded in the alarm history regardless of the setting value of this parameter.



(PR)	#1239	set11
		<p><b>bit0: Coil switching method</b></p> <p>Select the coil switching method.</p> <p>0: Via PLC. (Y189F)</p> <p>1: NC internal processing. (Y189F is invalid.)</p> <p><b>bit3: Polygon machining mode at reset</b></p> <p>Select whether to cancel the polygon machining mode when reset is applied.</p> <p>0: Not cancel.</p> <p>1: Cancel.</p> <p><b>bit4: Invalidate G51.1 phase command</b></p> <p>Select whether to enable the phase control with the spindle-spindle polygon function.</p> <p>0: Always enable. (When R is not commanded, it will be handled as R0.)</p> <p>1: Enable only at the R command.</p> <p><b>bit5: Door interlock spindle speed clamp valid</b></p> <p>Select whether to enable the spindle clamp speed changeover by the PLC signal.</p> <p>0: Disabled</p> <p>1: Enabled</p> <p><b>bit6: External deceleration axis compliance valid</b></p> <p>Designate the method for setting the external deceleration speed.</p> <p>0: Set speed common for all axes ("#1216 extdcc" (external deceleration speed))</p> <p>1: Set speed for each axis ("#2086 exdcax" (external deceleration speed))</p>

(PR)	#1240	set12
		<p><b>bit0: Handle input pulse</b></p> <p>Select the handle input pulse.</p> <p>0: MITSUBISHI CNC standard handle pulse (25 pulse/rev)</p> <p>1: Handle 400 pulse (100 pulse/rev)</p> <p><b>bit2: Zero point shift amount magnification</b></p> <p>If "1" is set, the following magnification will be applied on the #2027 G28sft reference point shift amount, #2057 zero point proximity + and #2058 zero point proximity - settings.</p> <p>For 0.1<math>\mu</math>m: 10-fold</p> <p>For 0.01<math>\mu</math>m: 100-fold</p> <p><b>bit4: Optical communication automatic channel detection invalid</b></p> <p>Select whether to enable the optical communication automatic channel detection.</p> <p>0: Enable</p> <p>1: Disable</p>

---

**#1241 set13**

---

**bit0: Prevention of program error due to incorrect G code combination**

When a G code from some modal groups is commanded in the same block as an unmodal G code, a program error due to incorrect G code combination occurs. This parameter is used to avoid this program error.

0: The program error (P45) will occur.

1: The program error is avoided, however, a G code from an uncombinable modal group is ignored.

**bit1: Interference check at starting up radius compensation (for M system only)****Interference check at starting up nose R compensation (for L system only)**

0: In a start-up block, an interference check is not carried out.

1: An error occurs even at a start-up block if an interference occurs.

The error occurs even when the interference avoidance is set to ON (#8102="1"). However, an interference check is not carried out when it is set to OFF (#8103="1").

**bit4: Plane axis check invalid in fixed cycle for turning machining**

Select whether to raise a program error when a fixed cycle for turning machining is commanded in either of the following conditions:

\* The commanded axis does not coincide with the selected plane

\* One or both of the selected plane axes have no movement

0: Raise a program error

1: Not raise a program error

**bit5: Macro argument L/P valid**

Select whether to enable L and P to be used as argument of G(MSTB) macro command or ASCII code macro command.

0: L and P commands cannot be used.

1: L and P commands can be used as argument.

**bit7: Spindle rotation speed during synchronous tap return**

Specify how to operate in a sync tap command block if the tap return spindle rotation speed (,S) is lower than the tap spindle rotation speed (S).

0: Operate at the tap return spindle rotation speed (,S)

1: Operate at the tap spindle rotation speed (S)

---

**#1242 set14**

---

**bit0: Ignoring timing sync in multi-system simultaneous thread cut cycle I (G76.1)**

Select whether to execute timing synchronization during multi-part system simultaneous thread cut cycle I (G76.1).

0: Execute timing synchronization at the start and end of thread cutting.

1: Ignore the timing synchronization given during the cycle.

**bit1: G92.1 single command error check ON**

Select whether to enable the error check when G92.1 (G50.3) is given alone in a block.

0: Disable the error check

1: Enable the error check

**bit6: G113 command type when multiple spindle synchronization set valid**

Specify the G113 command type of when multiple spindle synchronization set is valid.

0: Cancels all the spindle synchronization by issuing G113H0 or G113D0.

1: Cancels all the spindle synchronization by issuing G113.

---

**#1243 set15**

---

Not used. Set to "0".

#1244

set16

**bit0: No superimposition of timing synchronization block onto subsequent block**

- 0: Superimpose a block, where timing synchronization command is given as a single command, onto the subsequent block, and treat the blocks as one block
- 1: Treat a block, where timing synchronization command is given as a single command, as one block.

**bit1: Enable automatic re-calculation after timing synchronization**

- 0: Look-ahead a block next to the timing synchronization command block
- 1: Automatically re-calculate a block next to the timing synchronization command block after the synchronization has been completed.

**bit2: Balance cut in all the blocks**

Select in which block(s) to execute synchronization between part systems when a balance cut command is given.

- 0: Execute synchronization in cutting feed command block(s)
- 1: Execute synchronization in all the blocks

**bit3: Enable tool offset at start/stop of arbitrary axis superimposition**

Not used. Set to "0".

**bit4: Speed clamp method under superimposition control**

Not used. Set to "0".

**bit5: Read of position info with superimposing travel distance taken into account**

Select whether to take into account the superimposing travel distance (travel distance of the reference axis) when reading position info (machine coordinates/skip coordinates) using a variable under control axis superimposition or arbitrary axis superimposition control.

- 0: Not take the distance into account
- 1: Take the distance into account

**bit6: Axis address check ON**

Select whether to output a program error (P32) when any address other than those specified by "#1013 ax-name" and "#1014 incax" is given as an axis address.

If the arbitrary axis exchange function is ON, select whether to output a program error (P32) when any address other than those specified by "#12071-12078 adr\_abs[1]-[8]" and "#12079-12086 adr\_inc[1]-[8]" is given as an axis address.

- 0: Not output a program error (P32). (Ignore the axis address.)
- 1: Output a program error (P32)

#1245

set17

**bit7: Synchronous tap spindle rotation direction type**

Select whether the spindle's rotation direction is determined by the synchronous tapping axis' travel direction.

- 0: The spindle's rotation direction is determined by the synchronous tapping axis' travel direction.
  - When the travel direction is negative, the spindle rotates forward.
  - When the travel direction is positive, the spindle rotates in reverse.
- 1: The spindle always rotates forward regardless of the synchronous tapping axis' travel direction.

(Note) When a reverse tap is commanded, the spindle rotates in an opposite direction to that mentioned above.

#1246

set18

**bit0: Thread cut override ON**

Select whether to enable spindle override during thread cutting.

0: Disabled

1: Enabled

**bit1: Thread cut override feed hold**

Select whether to perform feed hold when spindle override is changed during thread cutting.

0: Not perform feed hold

1: Perform feed hold

**bit2: Switch coordinate systems for radius compensation**

Select the coordinate system for radius compensation.

0: Type 1 (conventional specification)

Perform radius compensation with reference to a position on the workpiece coordinate system.

1: Type 2

Perform radius compensation with reference to a position on the program coordinate system.

**bit3: Change repetition final return position at M2L**

Select the final return position after repetition, when in G99 modal and in M2 format with the label L.

0: Initial point

1: R point

**bit4: T-lifeover signal output**

Select the timing at which the "Tool life over" signal is output when using the M system tool life management I/II.

0: Turn the signal ON when a selected tool has reached the lifetime.

1: Turn the signal ON when any of tools (in the case of the tool life management III, all the registered tools) in a selected group has reached the lifetime.

**bit5: Tool status update type**

Select whether to update tool status automatically when estimated tool life data/cumulative usage data is changed on the screen in the M system tool life management I/II/III.

0: Do not update

1: Update.

(Note) When "1" is selected, tool status will be updated as follows.

•When usage data is "0", tool status will be "0".

•When usage data is smaller than lifetime data, tool status will be "1".

•When usage data is the same as or larger than lifetime data, tool status will be "2".

**bit6: Switch F 1-digit feedrate change method**

Set whether to enable feedrate change with handle until power OFF, or change the parameters #1185 to #1189 with change of speed.

0: Enabled until power OFF

1: Change "#1185 spd\_F1" to "#1189 spd\_F5"

**bit7: PLC axis random device assignment**

Select whether to enable PLC axis random device assignment for "Reference position return near-point detection" signal and "Stroke end" signal.

0: Disable (Fixed device is used.)

1: Enable (Device is specified by the parameter.)

<b>#1247</b>	<b>set19</b>
<b>bit0: Movement by tool length compensation command (for M system only)</b>	
Select whether or not to move the axis by the compensation amount when tool length compensation/cancel is independently commanded.	
0: Move	
1: Not move	
<b>bit1: Thread cutting operation when manual speed command enabled</b>	
Select the thread cutting operation in manual speed command.	
0: The axis travels at the handle feed rate, jog feed rate, or manual rapid traverse rate	
1: The axis travels following the program command	
<b>bit2: Inclined surface machining mode hold</b>	
Select whether to hold or cancel the inclined surface machining mode at an emergency stop or power OFF.	
0: Cancel the inclined surface machining mode.	
1: Hold the inclined surface machining mode.	
<b>#1248</b>	<b>set20</b>
Not used. Set to "0".	
<b>#1249</b>	<b>set21</b>
<b>bit5: Warning on 24Hr continuous ON display</b>	
Select whether to show or hide the alarm (V53 0001).	
0: Not display	
1: Display	
<b>#1250</b>	<b>set22</b>
Not used. Set to "0".	
<b>#1251</b>	<b>set23</b>
<b>bit0: Load inertia ratio display</b>	
Select whether to show the load inertia ratio of servo and spindle units on the drive monitor screen.	
0: Display	
1: Not display (Show zero)	
<b>bit1: Spindle temperature display</b>	
Select whether or not to display the spindle unit temperature on the drive monitor screen.	
0: Display according to "#13225 SP225/bit2"	
1: Not display (Show zero)	
<b>bit3: Non-display of completion message (display unit (GOT))</b>	
Select whether to display completion messages on the display unit (GOT).	
0: Display	
1: Not display	
<b>#1252</b>	<b>set24</b>
Not used. Set to "0".	

<b>(PR)</b>	<b>#1253</b>	<b>set25</b>
<b>bit0: Number of machine tool builder macro definition files</b>		
Select the number of definition files for machine tool builder macro.		
0: One (O199999999)		
1: Ten (O199999990 to O199999999)		
<b>bit2: Acceleration/Deceleration mode change in hole drilling cycle</b>		
Change the acceleration/deceleration mode of hole drilling cycle.		
0: The operation follows the parameter setting. The setting of #1153 is enabled.		
1: A constant inclination acceleration/deceleration and an acceleration/deceleration after interpolation are applied to the hole drilling cycle. The setting of #19417 is enabled.		
<b>bit4: Clearing data at fixed cycle mode switch</b>		
Select whether to zero clear the argument data at the time of fixed cycle mode switch.		
0: Do not zero clear the argument data		
1: Zero clear the argument data		
<b>bit5: G53 motion type</b>		
Change the motion type for G53 command.		
0: Cutting feed or rapid traverse is determined by the active modal status.		
1: Fixed to rapid traverse.		
<b>bit6: Switch G68/G69 function</b>		
Select whether to use G68/G69 as tool post mirror image function or balance cut function when the selected G code system is 6 or 7.		
0: Facing turret mirror image		
1: Balance cut		
<b>(PR)</b>	<b>#1254</b>	<b>set26</b>
<b>bit0: Reducing processing time of zero-travel-distance block (for L system only)</b>		
Select whether to reduce the processing time of a zero-travel-distance block.		
0: Disable the reduction of non-travel block processing time.		
1: Enable the reduction of non-travel block processing time.		
<b>bit3: Select timing for updating axis parameter</b>		
Select the timing for when to update axis parameter.		
0: Update after All axes smoothing zero turns ON for all the part systems.		
1: Update after All axes smoothing zero turns ON for each part system.		
<b>(PR)</b>	<b>#1255</b>	<b>set27</b>
Not used. Set to "0".		
<b>(PR)</b>	<b>#1256</b>	<b>set28</b>
<b>bit0: Switch to C axis mode at cancel of EMG stop/door open under spindle C axis</b>		
Select whether to switch the control to C axis mode when you execute and cancel emergency stop, or turn ON and OFF the door open signal under spindle C axis control mode. (This takes effect when spindle/C axis switch method is PLC signal type.)		
0: Not switch to C axis mode. Control is switched to C axis mode when C axis' Servo OFF signal is turned OFF and ON after cancel of emergency stop or door open.		
1: Switch to C axis mode when emergency stop or door open is cancelled.		
<b>bit2: Change current FB (load) output unit</b>		
Select the units in which the current FB (load) is output to a register. When output in units of 0.01%, the output range is from 0 to 327.67%.		
0: Default (Output in units of 1%).		
1: Output in units of 0.01%.		

	<b>#1257</b>	<b>set29</b>
	Not used. Set to "0".	
<b>(PR)</b>	<b>#1258</b>	<b>set30</b>
	<b>bit0: Skip I/F switch</b>	
	Select A or B contact for the skip interface.	
	0: A contact (Skip operation starts at rising edge of a signal)	
	1: B contact (Skip operation starts at falling edge of a signal)	
	(Note) This parameter is not applied to PLC skip.	
	<b>bit1: Alarm "Excess posn devia. at power ON" valid</b>	
	Select which alarm to be issued when a deviation of machine position between before the power OFF and after the power ON is greater than the value set in "#2051 check".	
	0: Alarm "Z70 0006 Absolute position error"	
	1: Alarm "Z70 0007 Excess posn devia. at power ON"	
	<b>bit4: Thread recut command</b>	
	Specify through which interface to give a thread recut command.	
	0: Through HMI screen	
	1: Through PLC I/F	
	<b>bit5: Addition of command Q to thread recut</b>	
	Select whether to add the command Q's data to the spindle angle to be compensated during thread recut of a stored thread section.	
	0: Not add the command Q's data	
	1: Add the command Q's data	
	<b>bit6: Spindle compensation angle in thread recut mode</b>	
	Select whether to calculate the spindle compensation angle when a thread cut command is given during the thread recut mode.	
	0: Calculate the angle for the initial thread cut command in automatic operation. (The initially calculated angle is used for the 2nd and subsequent thread cut commands.)	
	1: Calculate the angle every time a thread cut command is given.	
<b>(PR)</b>	<b>#1259</b>	<b>set31</b>
	<b>bit0: Enable normal life tool's data count (for M system only)</b>	
	Select whether to enable or disable too use data counting when the tool status is 2 (normal life tool).	
	0: Not count the use data of normal life tool.	
	1: Count the use data of normal life tool.	
	<b>bit2: Disabling decimal point for PLC window</b>	
	Select the input/output specifications of fraction data for PLC window.	
	0: Enable decimal point	
	Fraction data is output as the fixed fraction information.	
	(The numbers of digits in the integer and fraction parts are the same as of the on-screen specifications.)	
	1: Disable decimal point (cut off all digits after decimal point)	
	Only the integer part is input/output.	
	<b>bit7: Macro processing method</b>	
	Select the macro processing method.	
	0: High speed	
	1: Compatible with conventional models	
	(*) Remarks	
	Select whether to refresh the display data at regular intervals of a certain number of macro blocks when processing successive macro blocks.	
	Selecting "0" enables high-speed macro processing, because it creates no data for refreshing display.	
	Selecting "1" enables most of the blocks under processing to be viewed, because it creates display refresh data at regular intervals even for successive macro blocks.	
	When "1" is selected, the operation is the same as of M700 Series control.	

(PR)	#1260	set32
<b>bit4: Thread cut start shift angle operation</b>		
Select the operation to be performed at the start of thread cutting when a thread cut start shift angle command is issued.		
0: Start thread cut from the thread cut start shift angle after phase Z has been detected once.		
1: Start thread cut from the thread cut start shift angle, independently of phase Z detection.		
(PR)	#1261	set33
<b>bit1: Operation panel I/O emergency stop function OFF</b>		
Not used. Set to "0".		
<b>bit2: Synchronized turning ON/OFF of NC and display</b>		
Select whether to synchronize the turning ON/OFF of the M800W Series NC controller and display.		
0: NC and display turn ON/OFF independently.		
1: NC and display turn ON/OFF in synchronization with each other.		
(*) If no operation panel I/O unit is connected, the NC and display turn ON/OFF independently, irrespective of this parameter.		
<b>bit3: PLC high-speed process start timing selection</b>		
Select the type of PLC high-speed process start timing.		
0: Type 1 (default)		
1: Type 2		
<b>bit4: High-speed ladder execution cycle</b>		
Specify the high-speed ladder execution cycle. (Standard value: 0)		
0: Default		
1: Twice the default (equivalent to Mitsubishi M700V Series)		
(Note) When the parameter (#1261 set33/bit4) is set to its default value, the high-speed ladder execution cycle differs according to the model and the number of part systems.		
<b>bit5: Operation switch at OT and soft limit in synchronous operation method</b>		
This parameter switches the axis operation at stroke end and soft limit for slave axis in the synchronous operation method.		
When independent operation method or correction mode is set, the operation will be the same as #1261=0 (disable).		
0: When "Stroke end" signal is turned ON for only slave axis by stroke end or soft limit, the slave axis stops but master axis does not stop.		
1: When one of master axis or slave axis is in the stroke end or soft limit, both master and slave axes stop.		
(PR)	#1262	set34
Not used. Set to "0".		
(PR)	#1263	set35
<b>bit1: Show/Hide history clear menus</b>		
Show/Hide operation menus for data clear of collection setting screen, history clear of alarm history screen, history start, and history stop.		
0: Show history clearing operation menus		
1: Hide history clearing operation menus		
<b>bit2: Hide the alarm category of PLC message</b>		
Select whether to hide the alarm category of PLC message (macro alarm message).		
0: Display the alarm category		
1: Hide the alarm category		
<b>bit3: Overvoltage alarm switch</b>		
Select the alarm for overvoltage.		
0: Display the warning upon occurrence of overvoltage alarm.		
1: Execute emergency stop upon occurrence of overvoltage alarm.		



	<b>#1264</b>	<b>set36</b>
	Not used. Set to "0".	
<b>(PR)</b>	<b>#1265</b>	<b>ext01</b>
	<b>bit0: Command format 1</b>	
	Select the command format for the fixed cycle for compound lathe.	
	0: Conventional format	
	1: MITSUBISHI CNC special format (1 block command method)	
	<b>bit1: Command format 2</b>	
	Select the command format for the lathe fixed cycle.	
	0: Conventional format	
	1: MITSUBISHI CNC special format	
	<b>bit2: Command format 3</b>	
	Select the command format for the fixed cycle for drilling.	
	0: Conventional format	
	1: MITSUBISHI CNC special format	
	<b>bit3: F-command unit 2 (for L system only)</b>	
	Specify the unit to be used if a synchronous feed or thread cutting lead command contains no decimal point.	
	0: Type 1 (conventional specifications) or Type 2 Type 1 or Type 2 is selected by the parameter "#1271 ext07/bit2".	
	1: Type 3 F command 0.01 mm/rev, 0.0001 inch/rev E command Sync feed (corner chamfer/corner R feedrate) 0.01 mm/rev, 0.0001 inch/rev Thread cut (fine thread cut lead) 0.0001 mm/rev, 0.000001 inch/rev	
	(Note) Type 3 is independent of the input unit.	
<b>(PR)</b>	<b>#1266</b>	<b>ext02</b>
	<b>bit0: Axis name extension valid</b>	
	0: "Axis name extension" invalid	
	1: "Axis name extension" valid	
<b>(PR)</b>	<b>#1267</b>	<b>ext03</b>
	<b>bit0:</b>	
	Not used.	
<b>(PR)</b>	<b>#1268</b>	<b>ext04</b>
	<b>bit2: Enable synchronous tapping per minute</b>	
	Select whether to enable feed per minute with the F command of synchronous tapping cycle.	
	0: Disable (Command in pitch regardless of "G group 5" modal)	
	1: Enable (Follow "G group 5" modal)	
	<b>bit4: Enable address K to specify the repetition count in G76/G87</b>	
	Select whether to enable address K to be used for specifying the repetition count in G76/G87 command.	
	0: Disable	
	1: Enable	
	When "1" is set in this parameter with "#1271 ext07/bit1" (Specifying repetition count with address K) set to "1", the address K given to G76/G87 is treated as the number of repetitions.	

<b>(PR)</b>	<b>#1269</b>	<b>ext05</b>
<b>bit0: Inverse tangent (ATAN) command format</b>		
Select the command format of ATAN operation.		
0: Format 1		
Either the ratio of two sides or the whole expression is enclosed in square brackets "[ ]".		
ATAN[#k] or ATAN[#j/#k]		
1: Format 2		
Two sides are enclosed in "[ ]" respectively and also divided by a slash "/".		
ATAN[#j]/[#k]		
<b>bit1: Range of inverse tangent (ATAN) calculation result</b>		
Select the range of calculation result for inverse tangent (ATAN) to be applied when Format 2 is selected for inverse tangent (ATAN) command (when #1269/bit0 = 1).		
0: -180 to 180°		
1: 0 to 360°		
<b>(PR)</b>	<b>#1270</b>	<b>ext06</b>
<b>bit4: Switch chamfering operation</b>		
Select the operation to be performed when the cycle start point is exceeded as a result of chamfering in a thread cutting cycle.		
0: Output a program error (P192).		
1: Stop chamfering upon arrival at the cycle start point, and then move to the end point of the thread cutting block at a rapid traverse rate.		
<b>bit5: Coordinate rotation angle without command (for L system only)</b>		
Select the operation when there is no rotation angle command R for the coordinate rotation.		
0: Use the previously commanded value (modal value). If the command is the first issued command, the rotation angle will be 0°.		
1: Use the set value in "#8081 Gcode Rotat".		
<b>bit6: Switch continuous thread cutting Z phase wait operation</b>		
Select when to start the 2nd block thread cutting when there is a command with no movement (MST command, etc.) between the thread cutting blocks.		
0: Wait for the spindle's single rotation synchronization signal before starting the movement.		
1: Start movement without waiting for the spindle's single rotation synchronization signal.		
<b>bit7: Handle C axis coordinate during cylindrical interpolation</b>		
Specify whether to keep the rotary axis coordinate as before the cylindrical interpolation start command is issued during the cylindrical interpolation.		
0: Not keep		
1: Keep		

---

(PR)	#1271	ext07
------	-------	-------

---

**bit0: Mirror image operation**

Select the type of mirror image operation.

0: Type 1

- ♦The program mirror image, external mirror image, and parameter mirror image are exclusive to each other.
- ♦An incremental command moves the image to the position indicated by the travel amount with the sign inverted.

1: Type 2

- ♦Mirror image operation is enabled when the program mirror image (G51.1) command is issued or when the external signal or parameter is ON.
- ♦An incremental command moves the image to the position determined by applying the mirror image to the absolute program coordinates.

**bit1: Address specifying fixed cycle repetition count (for M system only)**

Select the address that specifies the fixed cycle repetition count.

0: Address L only (Default)

1: Addresses K and L

If addresses K and L are specified simultaneously, the data at address K will be used for operation.

**bit2: F-command unit**

(M system)

Specify the unit to be used if a thread cutting lead command contains no decimal point.

\* This setting is independent of the input unit.

0: Type 1 (conventional specifications)

F1: 1 mm/rev, 1 inch/rev

1: Type 2

F1: 0.01 mm/rev, 0.0001 inch/rev

(L system)

Specify the unit to be used if a synchronous feed or thread cutting lead command contains no decimal point.

0: Type 1 (conventional specifications)

[Input unit B] F1: 0.0001 mm/rev, 0.000001 inch/rev

[Input unit C] F1: 0.00001 mm/rev, 0.0000001 inch/rev

1: Type 2

F1: 0.0001 mm/rev, 0.000001 inch/rev

\* Type 2 is independent of the input unit.

**bit3: G-code group for unidirectional positioning (for M system only)**

Select the G-code group for unidirectional positioning.

0: Unmodal G code (group 00)

1: Modal G code (group 01)

Related parameter: "#8209 G60 Shift" (Set the last positioning direction and distance for each axis applicable when the unidirectional positioning command is issued.)

**bit4: Operation by independent G40 command**

Select whether the radius compensation vector is canceled by the independent G40 command.

0: Type 1 (conventional specification) (Default)

The radius compensation vector will be canceled by the independent G40 command.

1: Type 2

The radius compensation vector won't be canceled by the independent G40 command: it will be canceled by the next travel command for the radius compensation plane.

**bit5: Cut start position (for L system only)**

Select the position from where cutting begins in a fixed cycle for compound lathe.

0: Conventional specification (Default)

The cut start position will be determined by the final shaping program.

1: Extended specifications

Determined from the cycle start point.

**bit6: Nose R compensation (for L system only)**

Select whether to apply nose R compensation for shapes in a rough cutting cycle.

0: Conventional specification (Default)

The shape after nose R compensation in the final shaping program will be used as rough cutting shape. (when the nose R compensation for the final shaping program).

1: Extended specifications

The shape without nose R compensation in the final shaping program will be used as rough cutting shape.

**bit7: Cut amount (for L system only)**

Select the operation to be performed when the program-specified cut amount exceeds the cut amount of the final shaping program.

0: Conventional specification (Default)

A program error will occur when the program-specified cut amount exceeds the cut amount of the final shaping program.

1: Extended specifications

Rough cutting will be performed by one cut when the program-specified cut amount exceeds the cut amount of the final shaping program.

---

(PR) #1272 ext08

---

**bit0: Switch pocket machining operation**

Select the pocket machining specification.

0: Conventional specification

Pocket machining will be selected with the H designation.

The pull direction when pocket machining is ON will be the Z direction.

1: Extended specifications

Pocket machining will start only when both X and Z axes are specified in the first travel block after the finished shape start block.

The pull direction when pocket machining is ON will be the X direction.

**bit1: M function synchronous tap cycle**

Specify whether to enable the M function synchronous tapping cycle.

0: Disable

1: Enable

**bit2: Spiral/conical interpolation command format 2**

Select the command format for spiral and conical interpolation.

0: Type 1 (conventional specification)

1: Type 2 (with the number of spiral rotation L designation and the increment designation)

**bit3: Switch macro call function**

Select whether to shift the argument to the subprogram if nests are overlapped when per block call (G66.1) is commanded.

0: Shift

1: Not shift (Conventional specification)

**bit4: Tap cycle selection**

Select the tapping cycle.

0: Pecking tapping cycle

1: Deep hole tapping cycle

**bit5: Deep hole tap cycle override selection**

Select whether to enable override on the pulling operation during synchronized tapping with the deep hole tapping cycle.

0: Disable

1: Enable

**bit6: Switch corner chamfering/ corner R command format**

Select the command format of the corner chamfering/corner R.

0: Command format I (conventional format)

Issue a command with comma (,C and ,R).

1: Command format II

In addition to command format I, addresses without comma can be used to command. I/K or C can be used for corner chamfering, while R can be used for corner R.

**bit7: Return position after macro interrupt in fixed cycle selection**

Select the destination to return to after a macro interrupt in the fixed cycle.

0: Return to the block in the fixed cycle.

1: Return to the block next to the fixed cycle.

---

**(PR) #1273 ext09**

---

**bit0: Switch ASIN calculation results range**

Select the notation system for operation result of ASIN.

- 0: Do not switch minus figures to positive figures. (-90° to 90°)
- 1: Switch minus figures to positive figures. (270° to 90°)

**bit1: Switch system variable unit**

Select the unit for the system variable #3002 (cycle start operation time).

- 0: 1 ms unit
- 1: 1 hour unit

**bit2: Switch G71, G72, G73 cutting direction judgment**

Select the cutting direction when the longitudinal rough cutting cycle (G71), face rough cutting cycle (G72) or closed loop cutting cycle (G73) is commanded.

- 0: Conventional specification  
Determined according to the finished shape program.
- 1: Extended specifications  
Determined according to the finishing allowance and cutting allowance commanded in the program.

**bit3: Facing turret mirror image coordinate value type**

Select how to show the workpiece coordinate values of the axis for which the facing turret mirror image is valid.

- 0: Movements in the workpiece coordinate system are in the same direction as those in the workpiece machine coordinate system.
- 1: Movements in the workpiece coordinate system are in the opposite direction to those in the workpiece machine coordinate system.

**bit4: Facing turret mirror image valid axis selection**

Select the axis for which the facing turret mirror image is valid.

- 0: Fixed to 1st axis.
  - 1: Determined according to the plane selected when the facing turret mirror image is commanded.
- 

**(PR) #1274 ext10**

---

**bit2: M98 sequence No. address selection**

Select which address to use for calling a sequence No. in a sub program under sub program control (M98/M198).

- 0: Address H is used for specifying the sequence No.
- 1: Address Q is used for specifying the sequence No.

**bit4: Optional block skip operation changeover**

Select the optional block skip operation.

- 0: Enable or disable optional block skipping in the middle of a block according to the setting of "#1226 aux10/bit1".
- 1: Enable optional block skipping at the top and in the middle of a block.  
Note that a slash "/" on the right-hand side of equation or that in an equation between [ ] is handled as division operator.

**bit5: Use of G54Pn for selecting extended workpiece coordinate system**

Select whether to use G54Pn as a command for selecting an extended workpiece coordinate system.

- 0: Not use G54Pn as a command for selecting an extended workpiece coordinate system
- 1: Use G54Pn as a command for selecting an extended workpiece coordinate system

When 1 is set in this parameter, G54Pn is treated in the same manner as G54.1Pn.

**bit7: Word range check**

Select whether to check that the operation expression of the word data in the program is enclosed in brackets [ ] when the machine program is executed.

This check is also applied to the 08000 to 09999 and the machine tool builder macro program.

- 0: Not check
- 1: Check

(PR)	#1275	ext11
Not used. Set to "0".		
(PR)	#1276	ext12
Not used. Set to "0".		
(PR)	#1277	ext13
<b>bit0: Tool life management II count type 2 (default: 0)</b>		
Select how and when cumulative number of mountings or cuttings will be incremented in tool life management II. The condition to output "tool group life over (TGLO)" signal will be changed accordingly.		
0: Type 1 (default) Counts up when the spindle tool is used for cutting. TGLO signal will be output when the last tool in selected group is judged as expired.		
1: Type 2 Counts up by one for a tool used or mounted in a program at the time of resetting. TGLO signal will be output when any of tool groups has reached its lifetime limit.		
<b>bit1: Tool life management II life prediction</b>		
Select whether to enable tool life prediction function in tool life management II.		
0: Disabled		
1: Enabled		
<b>bit2: Tool life management II life end signal timing</b>		
Select the timing at which tool life prediction signal is output in tool life management II.		
0: Output only when the ["life value" - "used value"] matches the remaining life. ("life value" - "used value" = "remaining life")		
1: Output when the ["life value" - "used value"] is less than the remaining life. ("life value" - "used value" <= "remaining life")		
<b>bit3: Tool life management II life end signal tool</b>		
Select the tool for which the tool life prediction signal is output in tool life management II.		
0: Output the signal tool by tool.		
1: Output the signal at the last tool in the group.		
<b>bit4: Tool life management II count changeover (For M system only)</b>		
Select the tool life count method and its timing.		
0: Conforms to "ext13/bit0" setting.		
1: When "ext13/bit0" is set to "0": Counts up by one for a tool used or mounted in a program at the time of resetting. Follow the setting of "Method (Mthd)" on Tool life screen.		
The output condition of "tool group life over" signal conforms to "ext13/bit0".		

---

(PR)	#1278	ext14
------	-------	-------

---

**bit0: Program restart method selection**

Select the program restart type.

- 0: Restart type A
- 1: Restart type B

**bit1: Change miscellaneous command completion method**

Select the complete signal and completion condition.

- 0: Normal method  
Complete at the falling edge of M function finish 1 signal (FIN1) or rising edge of M function finish 2 (FIN2).
- 1: High-speed method  
Complete when High-speed M finish signal (MFIN1 to 4, SFIN1 to 6, TFIN1 to 4 or BFIN1 to 4) reaches the same logical level as the strobe signal.

**bit2: Change areas for stored stroke limit I**

Enable/Disable change of the areas for stored stroke limit I.

- 0: Disable
- 1: Enable

**bit3: Select M30 rewinding operation**

Select the operation when the miscellaneous function completed signal (FIN) is returned to M30.

- 0: Not carry out automatic rewinding
- 1: Carry out automatic rewinding

**bit4: Select M02 rewinding operation**

Select the operation when the miscellaneous function completed signal (FIN) is returned to M02.

- 0: Not carry out automatic rewinding
- 1: Carry out automatic rewinding

**bit5: M code output during high-speed simple program check**

Select whether to enable M code output during high-speed simple program check.

The M codes to be output are those specified by "#1451 M[M031-000](SMLK)" to "#1466 M[M511-480](SMLK)".

- 0: Disable
- 1: Enable

**bit7: Operation for circular radius error at perfect circle command**

Select the operation to be performed when a perfect circle command is given and there is a difference between the start point and end point radii, but no difference between the start point and end point angles.

- 0: Linear interpolation from the start to the end point
- 1: Spiral interpolation from the start to the end point



---

(PR) #1279 ext15

---

**bit0: Part system synchronization method**

Select the part system synchronization method.

- 0: If one part system is not in the automatic operation, the synchronization command will be ignored and the next block will be executed.
- 1: Operate according to the "waiting ignore" signal.  
If the "waiting ignore" signal is set to "1", the synchronization command will be ignored. When set to "0", synchronization will be applied.

**bit1: Interrupt amount during machine lock**

Select when to cancel the interruption amount during machine lock.

- 0: Canceled when resetting
- 1: Canceled during manual reference position return (not when resetting)

**bit2: Selection of cutting start interlock target block**

Select whether to enable the cutting start interlock for successive cutting blocks.

- 0: Enable
- 1: Disable

**bit4: Dry run OFF during thread cutting**

Select whether to enable or disable dry run during thread cutting.

- 0: Enable dry run
- 1: Disable dry run

**bit5: Cancel G92 shift distance**

Select whether to clear the G92 (coordinate system setting) shift distance when the manual reference position is reached.

- 0: Not clear
- 1: Clear

**bit6: Enable single block stop at middle point**

Set whether to enable/disable single block stop at the middle point of G28/G29/G30.

- 0: Disable single block stop
- 1: Enable single block stop

**bit7: Retain G52 at manual reference position return**

Select whether to retain the local coordinate system setting (G52) at the time of manual reference position arrival. This parameter is enabled when #1279 ext15/bit5 is 1.

- 0: Not retain (Cancel)
- 1: Retain

(PR)	#1280	ext16
------	-------	-------

**bit0: I/F per axis during mixed control (cross axis control)**

Select how to handle the following PLC interface for axes interchanged with the mixed control (cross axis control).

- Mirror image
- Manual/automatic interlock
- Manual/automatic machine lock

0: Follows axis configuration before the mixed control (cross axis control).

1: Follows axis configuration after the mixed control (cross axis control).

(Example)

The device No. of automatic interlock (+) for X1 will be as follows when the mixed control (cross axis control) is executed with the 1st axis (X1) in the 1st part system and 1st axis (X2) in the 2nd part system.

When "0" is set: YA60 (interface for 1st axis in 1st part system)

When "1" is set: YA68 (interface for 1st axis in 2nd part system)

(Note) If the number of axes in the part system changes with the mixed control (cross axis control), the interface of the target axis may change when this parameter is set to "1".

**bit1: Mixed control (cross axis control) cancel with reset**

Select whether to cancel the mixed control (cross axis control) when reset is applied.

0: Cancel.

1: Not cancel.

**bit2: Interchange coordinate position display**

Select whether to display interchanged (or moved) coordinate positions in the mixed control (cross axis control).

This setting will be followed not only when the axes are interchanged but also when the axes are moved.

0: Display interchanged (or moved) coordinate positions.

1: Display coordinate positions without being interchanged (nor moved).

(Example)

When 1st part system's C axis is moved to 2nd part system with a 1st part system (X, Z, C, Y) and 2nd part system (X, Z) configuration:

1st part system: X, Z and Y coordinate positions are displayed.

2nd part system: X, Z and C coordinate positions are displayed.

**bit3: Reset operation for synchronization/superimposition control**

Not used. Set to "0".

**bit4: Mixed control (cross axis control) command method**

Select how to command mixed control (cross axis control).

0: Use PLC interface signal for mixed control

1: Use G command for mixed control

**bit5: Command method of control axis synchronization between part systems**

Select how to command the control axis synchronization between part systems.

0: Use PLC I/F.

1: Use G command.

**bit6: Interchange machine position display**

Select whether to display interchanged (or moved) machine positions in the mixed control (cross axis control).

This setting will be followed not only when the axes are interchanged but also when the axes are moved.

(Note 1) This parameter is enabled when "#1280 ext16/bit2 (Interchange coordinate position display)" is "0".

0: Display interchanged (or moved) machine positions.

1: Display machine positions without being interchanged (nor moved).

**bit7: Control axis superimposition command method**

Not used. Set to "0".

---

(PR) #1281 ext17

---

**bit0: Switch manual high-speed reference position return in synchronous control**

Select the movement of synchronized axes in manual high-speed reference position return.

- 0: Master and slave axes start the return synchronizing. Even when one axis stops at its reference position, the other axis continues moving until it reaches its reference position.
- 1: Master and slave axes start the return synchronizing, and when the master axis stops at the reference position, the slave axis also stops. Thus, the relative position of the master and slave is kept.

**bit1: Selection of additional tool offset axis (for L system only)**

Select axis to carry out the additional axis' tool compensation function.

- 0: Follow the setting of "#1520 Tch34".
- 1: The axis specified by "#1027 base\_J" is used as the 3rd compensation axis.

**bit3: Synchronous control operation setting**

Select whether or not the positioning of slave axis automatically aligns with that of master axis when the axis subject to synchronous control is changed from servo OFF to servo ON.

- 0: The positioning does not automatically align.
- 1: The positioning automatically aligns.

**bit5: High-speed synchronous tapping valid**

Select whether to enable the high-speed synchronous tapping.

- 0: Disable
- 1: Enable

**bit6: Compensation method for external machine coordinate system/ball screw thermal expansion during synchronization**

Select the method of how to compensate the slave axis when compensating external machine coordinate system or ball screw thermal expansion during synchronization control. The setting of this parameter will be validated when you select synchronous operation method by the synchronization control operation method signal.

- 0: Master axis and slave axis are independently compensated.
- 1: Master axis' compensation amount is applied to slave axis.

**bit7: Switch automatic high-speed reference position return in synchronous control**

Select the movement of synchronized axes in automatic high-speed reference position return.

- 0: Master and slave axes start the return synchronizing, and when the master axis stops at the reference position, the slave also stops. Thus, the relative position of the master and slave is kept.
- 1: Master and slave axes start the return synchronizing. Even when one axis stops at its reference position, the other axis continues moving until it reaches its reference position.

---

<b>(PR)</b>	<b>#1282</b>	<b>ext18</b>
-------------	--------------	--------------

---

**bit1: Condition of the reference position reached signal in synchronous control**

This parameter switches only conditions of a master axis's reference position return reached signal in synchronous operation. A slave axis's signal is output when the slave axis reaches the reference position coordinate.

- 0: A master axis's reference position reached signal is output only when both of the master and slave axes reach the reference position coordinate by a reference position return.
- 1: A master axis's reference position reached signal is output when the master axis reaches the reference position coordinate.

**bit3: Index table clamp type**

Set the clamp type of the index table.

- 0: Type A  
Clamped when an unclamp command turns OFF.
- 1: Type B  
Clamped when a clamp command turns ON.

**bit5: Automatic correction of synchronization offset at power ON**

The slave axis position is automatically corrected so that the synchronization offset before having turned the power OFF the last time can be restored at power ON.

(Note) This parameter is enabled when the parameter "#1281 ext17/bit3" (Synchronous control operation setting) is set to "1".

- 0: Disable
- 1: Enable

**bit6: Reset type at emergency stop cancel**

Select the type of reset to be applied when emergency stop is cancelled.

- 0: Reset 1
- 1: Reset 2

**bit7: Functional operation inhibition during write of servo parameters**

Select whether to inhibit functional operation during write of servo parameters.

- 0: Inhibit functional operation with an alarm displayed
- 1: Give priority to functional operation with write of servo parameters suspended

(Note) This parameter can inhibit a start of the following four functions.

- Spindle/C axis changeover
- Speed observation mode signal ON
- High-speed synchronous tapping
- Start of PLC indexing axis

---

<b>(PR)</b>	<b>#1283</b>	<b>ext19</b>
-------------	--------------	--------------

---

Not used. Set to "0".

(PR)	#1284	ext20
<b>bit0: Spindle speed clamp check</b>		
Select whether to check the spindle speed clamp under the constant surface speed control.		
0: Check the spindle speed clamp.		
1: Not check the spindle speed clamp.		
(Note) This parameter is enabled when the parameter "#1146 Sclamp" is set to "1".		
<b>bit1: Spindle control selected in response to Z83 (NC started during SP rotation)</b>		
Select whether to force-stop the spindle when the alarm (Z83 0001) occurs.		
0: Not force-stop the spindle		
1: Force-stop the spindle		
<b>bit6: Automatic operation handle interruption during inclined surface machining</b>		
Select whether to enable the automatic operation handle interruption function during inclined surface machining.		
0: Disable		
1: Enable		
(PR)	#1285	ext21
<b>bit0: Multi-part system program management</b>		
Select whether to use multi-part system program management.		
0: Not use		
1: Use		
(Note) When this parameter's value is changed, the power must be turned OFF and ON, and the system formatted. Two or more part systems from [1] to [4] need to be set to "1" in "#1001 SYS_ON". Otherwise this parameter will be disabled even though set to "1".		
<b>bit1: Program search type switch</b>		
Select how to search a program to operate.		
0: Operation search is performed in the selected part system.		
1: Operation search is performed for all part systems. (The program No. will be common to all part systems.)		
<b>bit2: Multi-part system program generation and operation</b>		
Select whether to perform the following processes for all the part systems or for each part system separately in multi-part system program management: newly create, delete or rename the machining programs in NC memory (including MDI program and machine tool builder macro program) or transfer, compare, merge the programs between NC memory and other device.		
0: Perform these processes for the programs in all the part systems. If no subprogram contents are found by the subprogram call during automatic operation, the program will be searched for and executed from \$1.		
1: Perform these processes for the programs in the selected part system.		
(PR)	#1286	ext22
<b>bit5: Selection of multi-part system program input/output method</b>		
Select whether to perform the transfer from NC memory to other device for all the part systems or for each part system separately in multi-part system program management.		
0: Output the designated programs for all the part systems. (The programs output from NC memory contain the system delimiter \$ marks.)		
1: Output the programs of only the selected part system.		

(PR)	#1287	ext23
		<p><b>bit1: Inclined surface coordinate display</b></p> <p>0: Display the position which includes tool length offset. 1: Display the position on the program which excludes tool length offset.</p> <p><b>bit2: Inclined surface coordinate display (for M system only)</b></p> <p>0: Display the position which includes tool radius compensation. 1: Display the position on the program which excludes tool radius compensation.</p> <p><b>bit4: Relative coordinate display</b></p> <p>(M system) 0: Display the position which includes tool length offset. 1: Display the position on the program which excludes tool length offset.</p> <p>(L system) 0: Display the position which includes tool shape compensation. 1: Display the position on the program which excludes tool shape compensation.</p> <p><b>bit5: Relative coordinate display</b></p> <p>(M system) 0: Display the position which includes tool radius compensation. 1: Display the position on the program which excludes tool radius compensation.</p> <p>(L system) 0: Display the position which includes nose R compensation. 1: Display the position on the program which excludes nose R compensation.</p> <p><b>bit6: Absolute coordinate display</b></p> <p>Select how coordinate values are displayed when absolute coordinate display is selected ("#1221 aux05/bit0"="1"). (L system) 0: Display the position which includes tool shape compensation. 1: Display the position on the program which excludes tool shape compensation.</p> <p><b>bit7: Absolute coordinate display</b></p> <p>Select how coordinate values are displayed when absolute coordinate display is selected ("#1221 aux05/bit0"="1"). (L system) 0: Display the position which includes nose R compensation. 1: Display the position on the program which excludes nose R compensation.</p>
(PR)	#1288	ext24
		<p><b>bit0: MDI program clear</b></p> <p>Select whether to clear the MDI programs when MDI operation ends, the power is turned ON again, reset is input, or emergency stop is canceled. 0: Not clear 1: Clear (save only % programs).</p> <p><b>bit2: Restore previous program before external search by NC reset</b></p> <p>Select whether to restore the previous program before external search when operation is finished, power is turned OFF and ON, NC reset is input or Emergency stop is cancelled. 0: Not restore the previous program before external search 1: Restore the previous program before external search</p> <p><b>bit3: Restore previous program before external search by Program restore signal</b></p> <p>Select whether to restore the previous program before external search when Program restore signal is input. 0: Not restore the previous program before external search 1: Restore the previous program before external search</p>

(PR)	#1289	ext25
<b>bit0: Tool radius compensation switch corner judgment method (nose R compen.)</b>		
Select the criterion to execute the outer rounding at the small corner in tool radius compensation.		
(L system)		
0: The corner angle is 0°; linear-linear; G02-G03/G03-G02; the radius is the same. (Conventional method)		
1: The corner angle is 1° or smaller; linear-linear; G02-G03/G03-G02; the radius is almost the same. (Method for rounding minute corner angle)		
(M system)		
0: The corner angle is 1° or smaller; linear-linear; G02-G03/G03-G02. (Conventional method)		
1: The corner angle is 1° or smaller; linear-linear; G02-G03/G03-G02; the radius is almost the same. (Method for rounding minute corner angle)		
(PR)	#1290	ext26
Not used. Set to "0".		
(PR)	#1291	ext27
<b>bit2: Variable command: Reset operation for tool function T code (#4120/#4320)</b>		
Select how reset operation affects the address T's modal information (#4120/#4320).		
0: Clear the information		
1: Retain the information		
(PR)	#1292	ext28
<b>bit1: Address F given in sync tap cycle</b>		
Select the specification of address F given in synchronous tapping cycle.		
0: The value given to address F in synchronous tapping cycle is treated as the feed rate. Feed command follows the setting of "#1268 ext04/bit2 Enable synchronous tapping per minute". F modal status is unchanged.		
1: Follow the G code group 5 modal status, irrespective of the setting of "#1268 ext04/bit2 Enable synchronous tapping per minute". The F modal value given in the program is treated as the feed rate.		
<b>bit5: Selection of sub program call operation in fixed cycle mode</b>		
Select the operation to be carried out when sub program call (M98/M198) and either an axis address or address R (for hole drilling cycle) are given in one block during fixed cycle for drilling or turning machining.		
0: Not execute fixed cycle operation in the sub program call block.		
Sub program call is executed after travelling to the position specified by the axis address in modal status of G code group 01. Neither the axis address nor address R affects the subsequent fixed cycle operation.		
1: Execute fixed cycle operation in the sub program call block before executing the sub program call. The axis address or address R is treated as the fixed cycle argument.		
(PR)	#1293	ext29
<b>bit0: Synchronous feed in milling</b>		
Select whether to enable synchronous feed in milling interpolation, cylindrical interpolation or polar coordinate interpolation mode.		
0: Disable		
1: Enable		
<b>bit1: Enabling N0 command</b>		
Select how to handle a command of sequence number zero (N0).		
0: N0 causes an error.		
1: N0 is ignored (causes no error).		
(PR)	#1294	ext30
Not used. Set to "0".		
(PR)	#1295	ext31
Not used. Set to "0".		

(PR)	#1296	ext32	
<b>bit5: Behavior at subprogram call/subprogram end block</b>			
Select whether the subprogram call block is interpreted as an executable statement or as a macro statement. When macro statement is selected, the block is batch processed with the adjacent macro statements.			
This parameter changes the behavior at M98, M99, G65 or G66.1 command.			
0: Executable statement			
1: Macro statement			
(PR)	#1297	ext33	
Not used. Set to "0".			
(PR)	#1298	ext34	
Not used. Set to "0".			
(PR)	#1299	ext35	
Not used. Set to "0".			
(PR)	#1300	ext36	
<b>bit0: Multiple spindle control II</b>			
Select multiple spindle control I or II.			
0: Multiple spindle control I (L system only)			
1: Multiple spindle control II (select from ladder)			
<b>bit2: Part system-based spindle clamp speed management</b>			
Select how to manage the spindle clamp speed data.			
0: Manage the data of all part systems collectively			
1: Manage the data of each part system individually			
<b>bit7: Spindle synchronization command method</b>			
Select the spindle synchronization command method.			
0: Spindle synchronization with PLC I/F			
1: Spindle synchronization with machining program			
	#1301	nrfchk	<b>Near reference position check method</b>
Select the high-speed check method of the origin neighboring signal.			
0: Do not check positions near the origin at high speeds. (Conventional specifications)			
1: Check positions near the origin at high speeds using command machine positions.			
2: Check positions near the origin at high speeds using encoder feedback positions.			
	#1302	AutoRP	<b>Automatic return by program restart</b>
Select the method to move to the restart position when restarting the program.			
0: Move the system manually to the restart position and then restart the program.			
1: The system automatically moves to the restart position at the first activation after the program restarts.			
(PR)	#1303	V1comN	<b>No. of #100 address part system common variables</b>
Set the number of common variables, common for part systems, starting from address #100.			
This is valid only when "#1052 MemVal" is set to "1".			
---Setting range---			
0 to 100			
(PR)	#1304	V0comN	<b>No. of #500 address part system common variables</b>
Set the number of common variables, common for part systems, starting from address #500.			
This is valid only when "#1052 MemVal" is set to "1".			
---Setting range---			
0 to 500			



	<b>#1306</b>	<b>InpsTyp</b>	<b>Deceleration check specification type</b>
			Select the parameter specification type for the G0 or G1 deceleration check. 0: Deceleration check specification type 1 G0 is specified with "#1193 inpos", and G1+G9 with "#1223 aux07/bit1". 1: Deceleration check specification type 2 G0 or G1+G9 is specified with "#1193 inpos".
(PR)	<b>#1307</b>	<b>G0acc_plc</b>	<b>PLC axis G00 constant inclination valid</b>
			Set a type of acceleration/deceleration for the rapid traverse command. 0: Acceleration and deceleration with constant time (conventional type) 1: Acceleration and deceleration with a constant angle of inclination
(PR)	<b>#1308</b>	<b>G1acc_plc</b>	<b>PLC axis G01 constant inclination valid</b>
			Select the type of acceleration/deceleration for the cutting feed command. 0: Acceleration and deceleration with constant time (conventional type) 1: Acceleration and deceleration with a constant angle of inclination
(PR)	<b>#1309</b>	<b>GType</b>	<b>Switch command format</b>
			Select which is used to command the reverse tap. 0: G84.1/G88.1 1: D command with the value changed to negative
	<b>#1310</b>	<b>WtMmin</b>	<b>Minimum value for synchronization M code</b>
			Set the minimum value for the M code. When "0" is set, the synchronization M code will be invalid. ---Setting range--- 0, 100 to 99999999
	<b>#1311</b>	<b>WtMmax</b>	<b>Maximum value for synchronization M code</b>
			Set the maximum value for the M code. When "0" is set, the synchronization M code will be invalid. ---Setting range--- 0, 100 to 99999999
	<b>#1312</b>	<b>T_base</b>	<b>Tool life management standard number</b>
			Set the standard No. for the tool life management. When the value specified by the T code command exceeds the set value in this parameter, the set value will be subtracted from the command value, which will be used as tool group No. for tool life management. When the value specified by the T code command is equal to or less than the set value, the T code will be handled as a normal T code and not subjected to tool life management. When "0" is set in this parameter, the T code command will always specify a group No. (Valid for M-system tool life management II.) ---Setting range--- 0 to 9999
	<b>#1313</b>	<b>TapDw1</b>	<b>Synchronous tap hole bottom wait time</b>
			Set the hole bottom wait time for synchronous tapping. When P address is specified, the greater value will be used as the hole bottom wait time. When an in-position check is performed at the hole bottom, the wait time will be provided after the completion of the in-position check. (Note) This parameter is valid only when "1" is set in "#1223 aux07/bit3" (synchronous tap in-position check improvement) and "#1223 aux07/bit4" (synchronous tap hole bottom in-position check). ---Setting range--- 0 to 999 (ms)
	<b>#1314</b>	<b>TapInp</b>	<b>Synchronous tap in-position check width (tap axis)</b>
			Set the hole bottom in-position check width for synchronous tapping. (Note) This parameter is valid only when "1" is set in "#1223 aux07/bit3" (synchronous tap in-position check improvement) and "#1223 aux07/bit4" (synchronous tap hole bottom in-position check). ---Setting range--- 0.000 to 99.999

<b>(PR)</b>	<b>#1316</b>	<b>CrossCom</b>	<b>Reference of common variables common for part systems</b>
			<p>Select whether to use the common variables from #100100 to #800199.</p> <p>0: Not use 1: Use</p> <p>This parameter is valid only when the number of variable sets is set to 600 or more.</p> <p>When this parameter is set to "1", variables from #100100 to #100110 will not be available as the system variables for PLC data read function, and the setting of "#1052 MemVal" will be invalid.</p>
<b>(PR)</b>	<b>#1318</b>	<b>MacVcom</b>	<b>Machine tool builder macro variables for each part system</b>
			<p>In a multi-part system configuration, select whether to use the machine tool builder macro variables (#450 to #499, #80000 to #80049 and #80500 to #80649) in common to all part systems or individually for each part system.</p> <p>0: #450 to #499, #80000 to #80049 and #80500 to #80649 are used in common. 1: #450 to #499 are used in common to part systems. #80000 to #80049 and #80500 to #80649 are individual for each part system. 2: #450 to #499 are individual for each part system. #80000 to #80049 and #80500 to #80649 are common to part systems. 3: #450 to #499, #80000 to #80049 and #80500 to #80649 are used individually for each part system.</p>
	<b>#1319</b>	<b>Grp24_mdrst_off</b>	<b>G group 24 modal retention reset OFF</b>
			Not used.
<b>(PR)</b>	<b>#1324</b>	<b>chop_R</b>	<b>Chopping compensation value fixing method</b>
			<p>Set the head No. of the R register used as the compensation amount save area during fixed compensation amount method.</p> <p>When the first number is an odd number, the operation message "Setting error" appears.</p> <p>When the value overlaps with the chopping control data area, the operation message "Setting error" appears.</p> <p><b>---Setting range---</b> 8300 to 9782 (Only the even number) (Within backup area)</p>
<b>(PR)</b>	<b>#1326</b>	<b>PLC Const Ext. Num</b>	<b>PLC constant extension number</b>
			Not used. Set to "0".
	<b>#1327</b>	<b>3D ATC type</b>	<b>Tool change method specification</b>
			<p>Select the tool change method for determining the tool to draw solids.</p> <p>With 3D drawing, the tool will be changed by the method designated with this parameter, and then the image will be drawn.</p> <p>0: With one standby tool 1: With two standby tools 2: With no standby tool</p>
	<b>#1328</b>	<b>TLM type</b>	<b>Reference position for tool measurement</b>
			<p>Select the reference position for tool measurement.</p> <p>0: The machine position at the time when TLM is turned ON 1: The machine zero point</p>
	<b>#1329</b>	<b>Emgcnt</b>	<b>Emergency stop contactor shut-off time</b>
			<p>Set the time taken for the drive section's main power to be shut-off when the confirmation of all the axes' stop failed after the emergency stop state.</p> <p>The contactor shut-off signal is output as soon as all the axes are confirmed stopped if the confirmation is done prior to the set time.</p> <p>When there is no safety observation option or "0" is set, the shut-off time will be 30 (s).</p> <p><b>---Setting range---</b> 0 to 60 (s)</p>

<b>(PR)</b>	<b>#1330</b>	<b>MC_dp1</b>	<b>Contactor weld detection device 1</b>
			<p>When safety observation is executed, set the remote I/O device to input the contactor's auxiliary b contact signal used for the contactor weld detection.</p> <p>If "0" is set, weld detection will not be executed.</p> <p>Thus, "X0" cannot be used as contactor weld detection device.</p> <p><b>---Setting range---</b></p> <p>0000 to 01FF (HEX)</p>
<b>(PR)</b>	<b>#1331</b>	<b>MC_dp2</b>	<b>Contactor weld detection device 2</b>
			<p>When safety observation is executed, set the remote I/O device to input the contactor's auxiliary b contact signal used for the contactor weld detection.</p> <p>If "0" is set, weld detection will not be executed.</p> <p>Thus, "X0" cannot be used as contactor weld detection device.</p> <p><b>---Setting range---</b></p> <p>0000 to 01FF (HEX)</p>
	<b>#1333</b>	<b>LMC restrain</b>	<b>Lost motion compensation restraint in handle mode</b>
			<p>Select whether to restrain the lost motion compensation in handle mode.</p> <p>0: Not restrain</p> <p>1: Restrain</p>
<b>(PR)</b>	<b>#1334</b>	<b>DI/DO refresh cycl</b>	<b>DI/DO refresh cycle</b>
			<p>Select the start cycle of PLC main processing program.</p> <p>When wait time until the next start cycle from 1 scan end is long, the wait time can be shortened by adjusting the start cycle.</p> <p>-1: Low-speed mode (2 fold)</p> <p>0: Standard mode</p> <p>1: High-speed mode 1 (1/2 fold)</p> <p>2: High-speed mode 2 (1/4 fold)</p> <p>(Note 1) When the high-speed mode is selected, the fine segment processing performance may degrade due to the increased processing load of the system.</p> <p>(Note 2) When the high-speed mode 2 is selected, the scan time should be 1/4 or less of the base interruption cycle as a standard. If the standard is exceeded, the update of all the DI/DOs in refresh cycle may not be able to be performed.</p> <p>(Note 3) If the number of RIO stations connected is large, the update of all the RIO in refresh cycle may not be able to be performed. Make the setting according to the number of stations per RIO channel.</p>
	<b>#1335</b>	<b>man_smg</b>	<b>Manual feed acceleration/deceleration selection</b>
			<p>Select the acceleration/deceleration mode in jog feed, incremental feed and manual reference position return (when rapid traverse signal OFF).</p> <p>0: Acceleration/Deceleration for rapid traverse</p> <p>1: Acceleration/Deceleration for cutting feed</p>
<b>(PR)</b>	<b>#1336</b>	<b>#400_Valtype</b>	<b>#400 address variable type</b>
			<p>Select whether the #400-level variables are used as machine tool builder macro variables or as common variables.</p> <p>0: #400 to #449 are not available; #450 to #499 are used as machine tool builder macro variables.</p> <p>1: #400 to #499 are used as common variables</p> <p>(Note) 700 sets or more of common variables are required for using #400 to #499 as common variables. If this parameter is set to "1" while the number of common variables is set to less than 700, this parameter setting will be regarded as "0".</p>
<b>(PR)</b>	<b>#1338</b>	<b>rev data save trg</b>	<b>Trigger switching to save arbitrary reverse run data</b>
			Not used. Set to "0".

<b>(PR)</b>	<b>#1339</b>	<b>MC_dp3</b>	<b>Contactor weld detection device 3</b>
			<p>When safety observation is executed, set the remote I/O device to input the contactor's auxiliary b contact signal used for the contactor weld detection.</p> <p>If "0" is set, weld detection will not be executed.</p> <p>Thus, "X0" cannot be used as contactor weld detection device.</p> <p><b>---Setting range---</b></p> <p>0000 to 01FF (HEX)</p>
<b>(PR)</b>	<b>#1340</b>	<b>MC_dp4</b>	<b>Contactor weld detection device 4</b>
			<p>When safety observation is executed, set the remote I/O device to input the contactor's auxiliary b contact signal used for the contactor weld detection.</p> <p>If "0" is set, weld detection will not be executed.</p> <p>Thus, "X0" cannot be used as contactor weld detection device.</p> <p><b>---Setting range---</b></p> <p>0000 to 01FF (HEX)</p>
	<b>#1342</b>	<b>AlmDly</b>	<b>Alarm display delay time</b>
			<p>Set a period of time by which alarm display is delayed.</p> <p>Set a time between when an operation alarm occurs and when the alarm display and signal turn ON.</p> <p>When set to "0", the alarm display and signal will turn ON immediately after the alarm occurrence.</p> <p>When set to "-1", the alarm display and signal will not turn ON after the alarm occurrence.</p> <p>Target alarms:</p> <p>M01 External interlock axis exists 0004</p> <p>M01 Internal interlock axis exists 0005</p> <p>M01 Sensor signal illegal ON 0019</p> <p>M01 No operation mode 0101</p> <p>This parameter is disabled if "#1343 DlyReg" is set.</p> <p><b>---Setting range---</b></p> <p>-1 to 30000 (ms)</p>
<b>(PR)</b>	<b>#1343</b>	<b>DlyReg</b>	<b>R register for delayed alarm display setting</b>
			<p>Set the head No. of the R register to be used for delayed display of an operation alarm.</p> <p>If any R register outside the user area is specified, delayed alarm display is disabled.</p> <p>If this parameter is set, the setting of #1342 AlmDly is disabled.</p> <p>When not using, set to "0".</p> <p><b>---Setting range---</b></p> <p>0 to 29899</p>
<b>(PR)</b>	<b>#1349</b>	<b>DOOR_1</b>	<b>Door 1 switch input device</b>
			<p>Set a remote I/O device to input the door sensor signal to detect Door 1's status in safety observation.</p> <p>When "0" is set, the door is always detected to be open.</p> <p>Thus, "X0" cannot be used as Door 1 switch input device.</p> <p><b>---Setting range---</b></p> <p>0000 to 02FF (HEX)</p>
<b>(PR)</b>	<b>#1350</b>	<b>DOOR_2</b>	<b>Door 2 switch input device</b>
			<p>Set a remote I/O device to input the door sensor signal to detect Door 2's status in safety observation.</p> <p>When "0" is set, the door is always detected to be open.</p> <p>Thus, "X0" cannot be used as Door 2 switch input device.</p> <p><b>---Setting range---</b></p> <p>0000 to 02FF (HEX)</p>
<b>(PR)</b>	<b>#1353</b>	<b>MC_ct1</b>	<b>Contactor shutoff output 1 device</b>
			<p>Set a device of an output remote I/O device to control contactor in safety observation.</p> <p>When set to "0", contactor shutoff output is disabled.</p> <p>Thus, "Y0" cannot be used as contactor shutoff output device.</p> <p><b>---Setting range---</b></p> <p>0000 to 01FF (HEX)</p>

<b>(PR)</b>	<b>#1357</b>	<b>mchkt1</b>	<b>Contactor operation check allowed time 1</b>
			<p>Set a period of time until emergency stop is issued when a contactor does not operate even though contactor shutoff output 1 is output.</p> <p>If the vertical axis drop prevention function is used, set a value bigger than the vertical axis drop prevention time (SV048 EMGrT).</p> <p>When "0" is set, the contactor operation check will be disabled.</p> <p><b>---Setting range---</b></p> <p>0 to 30000 (ms)</p>
<b>(PR)</b>	<b>#1361</b>	<b>aux_acc</b>	<b>Auxiliary axis acceleration/deceleration type</b>
			<p>Select the acceleration/deceleration type of auxiliary axis in PLC axis indexing.</p> <p>0: Acceleration/deceleration with constant time</p> <p>1: Acceleration/deceleration with a constant angle of inclination</p>
	<b>#1365</b>	<b>manualFtype</b>	<b>Manual speed command type</b>
			<p>Select the manual speed command type.</p> <p>0: Manual speed command The axis travels at the handle/jog feed rate. Reverse run is performed for each part system independently of the other ones.</p> <p>1: Manual speed command 2 In a multi-part system configuration, the axis travels at the handle/jog feed rate multiplied by the ratio of each part system's program command speeds. When the block start point is reached in reverse run in any of the part systems, the axes in the other part systems stop simultaneously.</p>
	<b>#1366</b>	<b>skipExTyp</b>	<b>Multi-system simultaneous skip command</b>
			<p>Select the operation when G31 is commanded in more than one part system.</p> <p>(Note) When set to "1", the skip coordinate position will always be "0" whether G31 is commanded in a single part system or in one part system of a multi-part system. Set to "0" when using G31 command for measurement etc.</p> <p>0: Carry out G31 command in one part system, while the G31 is kept in an interlocked state in the other systems.</p> <p>1: Carry out G31 command simultaneously in more than one part system. Note that the skip coordinate is not read and so the skip coordinate value will be 0.</p>
	<b>#1367</b>	<b>G1AccOVRMax</b>	<b>Max. override value for cutting feed constant inclination acc./dec.</b>
			<p>Set the maximum override value to be applied to the cutting feed that is in constant inclination acceleration/deceleration.</p> <p>When the setting of this parameter is between 0 and 99, the override value is handled as 100% even though the specified cutting feed override is over 100%.</p> <p><b>---Setting range---</b></p> <p>0 to 300 (%)</p>
<b>(PR)</b>	<b>#1369</b>	<b>S_Sig1</b>	<b>Safety observation signal device 1</b>
			<p>Set the remote I/O device to input the observation speed change signal 1 during executing the safety observation function.</p> <p>When set to "0", there is no observation speed change signal input. Therefore "X0" cannot be used as safety observation signal device.</p> <p><b>---Setting range---</b></p> <p>0000 to 02FF (HEX)</p>
<b>(PR)</b>	<b>#1370</b>	<b>S_Sig2</b>	<b>Safety observation signal device 2</b>
			<p>Set the remote I/O device to input the observation speed change signal 2 during executing the safety observation function.</p> <p>When set to "0", there is no observation speed change signal input. Therefore "X0" cannot be used as safety observation signal device.</p> <p><b>---Setting range---</b></p> <p>0000 to 02FF (HEX)</p>

<b>(PR)</b>	<b>#1371</b>	<b>PwrIntegIntvl</b>	<b>Power consumption accumulation interval</b>
		Specify the intervals of accumulating power consumption to create the history. The accumulated power consumption history can be obtained according to this parameter along with "#1392 StartTimeIPC" (Power consumption accumulation start time). When 0 is set, power consumption is not accumulated.	
		<b>---Setting range---</b>	
		0 to 999 (hr)	
	<b>#1372</b>	<b>DrvBasePwr</b>	<b>Fixed drive system power consumption</b>
		Specify the fixed power consumption of the drive system. This value is used for calculating the power consumption.	
		<b>---Setting range---</b>	
		0 to 99999999 (W)	
<b>(PR)</b>	<b>#1373</b>	<b>mstpssc</b>	<b>Multi-step speed monitor enabled</b>
		Enable the multi-step speed monitor.	
		0: Disable the multi-step speed monitor	
		1: Enable the multi-step speed monitor	
		* When enabling the multi-step speed monitor, setting values for SV238, SV239, SP238 and SP239 will be ignored.	
<b>(PR)</b>	<b>#1379</b>	<b>S_Sig3</b>	<b>Safety observation signal device 3</b>
		Set the remote I/O device to input the observation speed change signal 3 during executing the safety observation function. When set to "0", there is no observation speed change signal input. Therefore "X0" cannot be used as safety observation signal device.	
		<b>---Setting range---</b>	
		0000 to 02FF (HEX)	
	<b>#1389</b>	<b>G1SmthChk</b>	<b>Smoothing check method in cutting block</b>
		Select whether to apply smoothing check method to a cutting block for deceleration check, when deceleration check method is selected individually for G0 and G1 (when "#1306 InpsTyp" = 1).	
		0: Follow the setting of Aux07/bit1	
		1: Apply smoothing check method	
<b>(PR)</b>	<b>#1390</b>	<b>BackUSBUseNum</b>	<b>Number of backside USB ports occupied</b>
		Specify the number of the display's rear USB ports occupied by a machine tool builder. Using this setting the control determines the drive to be used for the front SD and USB memory.	
		(Note) This parameter is enabled for a Windows-based display of M800W/M80W.	
		<b>---Setting range---</b>	
		0 to 6	
<b>(PR)</b>	<b>#1391</b>	<b>User level protect</b>	<b>Enable Data protection by user's level</b>
		Enable the function of Data protection by user's level.	
		0: Use a machine user password to switch the protection of each operation (same as the conventional models)	
		1: Switch the protection according to the protective levels (0 to 7) specified for each operation through the protection setting screen	
		(Note) You are authorized to change this parameter from 1 to 0 only if your operation level is the same or higher than that of "Available level" on the protection setting screen.	
<b>(PR)</b>	<b>#1392</b>	<b>StartTimeIPC</b>	<b>Power consumption accumulation start time</b>
		Specify when to start accumulating power consumption to create the history. The accumulated power consumption history can be obtained according to this parameter along with "#1371 PwrIntegIntvl" (Power consumption accumulation interval).	
		<b>---Setting range---</b>	
		0 to 23 (o'clock)	

#1393	Efficiency (PwrCal)	Efficiency for power consumption computation
	Specify the efficiency for calculating power consumption. This value is used for calculating the drive system power consumption. When 0 is set, the efficiency is treated as 70 (%). If the drive system power consumption computed by the NC is different from that measured by a measuring device, this parameter is used to adjust the drive system power consumption of the NC.	
	<b>---Setting range---</b> 0 to 100 (%)	
(PR) #1395	H1_pno	1st handle selection
	Specify the connection destination of the 1st handle. bit0 to bit3: Connection channel bit4 to bit7: Handle-connected CNC CPU module Setting value 0001: Host CNC CPU 1CH 0002: Host CNC CPU 2CH 0003: Host CNC CPU 3CH 0031: CNC CPU No. 2 1CH 0032: CNC CPU No. 2 2CH 0033: CNC CPU No. 2 3CH 0041: CNC CPU No. 3 1CH 0042: CNC CPU No. 3 2CH 0043: CNC CPU No. 3 3CH 0051: CNC CPU No. 4 1CH 0052: CNC CPU No. 4 2CH 0053: CNC CPU No. 4 3CH (Note 1) When the specified destination is not implemented, handle movement is not performed. (Note 2) When all the "H1_pno" to "H9_pno" are set to "0000", handles are automatically allocated. In case of arbitrary assignment, set "0000" for the handles which have not been assigned yet. (Note 3) The values set in bit8 to bitF are ignored.	
	<b>---Setting range---</b> 0x0000 to 0xFFFF	
(PR) #1396	H2_pno	2nd handle selection
	Specify the connection destination of the 2nd handle. Refer to "#1395 H1_pno" (1st handle selection) for further details.	
(PR) #1397	H3_pno	3rd handle selection
	Specify the connection destination of the 3rd handle. Refer to "#1395 H1_pno" (1st handle selection) for further details. (Note) In case of using C80, refer to "#11746 H4_pno" to "#11751 H9_pno" for the 4th to 9th handle selection.	
#1399	sp_filt	Spindle's actual rotation speed filter
	Specify the average filter scale factor for the spindle's actual rotation speed data. If the scale factor increases, fluctuations in speed display are mitigated.	
	0: Standard setting 1: 0.5-fold 2: 1-fold 3: 2-fold 4: 4-fold 5: 8-fold	

<b>#1401</b>	<b>M_mode</b>	<b>M command operation selection</b>
<p>Select the M command operation.</p> <p>(Note) Register M codes in the special operation registration M codes (#1411 to #1418).</p> <p>0: Not wait for the completion of registered M codes, but wait for the completion of the other M codes</p> <p>1: Wait for the completion of registered M codes, but not wait for the completion of the other M code</p>		
<b>#1402</b>	<b>S_mode</b>	<b>S command completion method selection</b>
<p>Select the S command completion method.</p> <p>0: Wait for the complete signal from PLC</p> <p>1: Not wait for the complete signal from PLC</p>		
<b>#1403</b>	<b>T_mode</b>	<b>T command completion method selection</b>
<p>Select the T command completion method.</p> <p>0: Wait for the complete signal from PLC</p> <p>1: Not wait for the complete signal from PLC</p>		
<b>#1404</b>	<b>M2_mode</b>	<b>2nd miscellaneous command completion method selection</b>
<p>Select the 2nd miscellaneous command completion method.</p> <p>0: Wait for the complete signal from PLC</p> <p>1: Not wait for the complete signal from PLC</p>		
<b>#1405</b>	<b>M_mode(SMLK)</b>	<b>M code output (during high-speed simple program check)</b>
<p>M code output (during high-speed simple program check)</p> <p>Select the M code output method to be applied during high-speed simple program check.</p> <p>0: Output the M codes registered in #1449 to #1464 M[M511-000](SMLK), but not output unregistered M codes. M512 or subsequent M codes are not output.</p> <p>1: Output the M codes unregistered in #1449 to #1464 M[M511-000](SMLK), but not output those registered. M512 and subsequent M codes are all output.</p>		
<b>#1406</b>	<b>S_mode(SMLK)</b>	<b>S code output (during high-speed simple program check)</b>
<p>S code output (during high-speed simple program check)</p> <p>Select the S code output method to be applied during high-speed simple program check.</p> <p>0: Not output S code</p> <p>1: Output S code</p>		
<b>#1407</b>	<b>T_mode(SMLK)</b>	<b>T code output (during high-speed simple program check)</b>
<p>T code output (during high-speed simple program check)</p> <p>Select the T code output method to be applied during high-speed simple program check.</p> <p>0: Not output T code</p> <p>1: Output T code</p>		
<b>#1408</b>	<b>M2_mode(SMLK)</b>	<b>2nd miscellaneous code output (during high-speed simple program check)</b>
<p>2nd miscellaneous code output (during high-speed simple program check)</p> <p>Select the 2nd M code output method to be applied during high-speed simple program check.</p> <p>0: Not output 2nd M code</p> <p>1: Output 2nd M code</p>		



#1411	M_wait[M031-000]	Special operation registration M code
		<p>Register an M code that needs special operation.</p> <p>Each bit of the set value corresponds to the M code number.</p> <p>(Example) To register M05, set 00000020 in #1411.</p> <p>(Note) Note that the registered M code operation varies according to M_mode (#1401).</p> <p><b>---Setting range---</b></p> <p>0 to FFFFFFFF</p> <p>Set this in hexadecimal format.</p>
#1412	M_wait[M063-032]	Special operation registration M code
		<p>Register an M code (32 to 63) that needs special operation.</p> <p>Each bit of the set value corresponds to the M code number.</p> <p>(Example) To register M05, set 00000020 in #1411.</p> <p>(Note) Note that the registered M code operation varies according to M_mode (#1401).</p> <p><b>---Setting range---</b></p> <p>0 to FFFFFFFF</p> <p>Set this in hexadecimal format.</p>
#1413	M_wait[M095-064]	Special operation registration M code
		<p>Register an M code (64 to 95) that needs special operation.</p> <p>Each bit of the set value corresponds to the M code number.</p> <p>(Example) To register M05, set 00000020 in #1411.</p> <p>(Note) Note that the registered M code operation varies according to M_mode (#1401).</p> <p><b>---Setting range---</b></p> <p>0 to FFFFFFFF</p> <p>Set this in hexadecimal format.</p>
#1414	M_wait[M127-096]	Special operation registration M code
		<p>Register an M code (96 to 127) that needs special operation.</p> <p>Each bit of the set value corresponds to the M code number.</p> <p>(Example) To register M05, set 00000020 in #1411.</p> <p>(Note) Note that the registered M code operation varies according to M_mode (#1401).</p> <p><b>---Setting range---</b></p> <p>0 to FFFFFFFF</p> <p>Set this in hexadecimal format.</p>
#1415	M_wait[M159-128]	Special operation registration M code
		<p>Register an M code (128 to 159) that needs special operation.</p> <p>Each bit of the set value corresponds to the M code number.</p> <p>(Example) To register M05, set 00000020 in #1411.</p> <p>(Note) Note that the registered M code operation varies according to M_mode (#1401).</p> <p><b>---Setting range---</b></p> <p>0 to FFFFFFFF</p> <p>Set this in hexadecimal format.</p>
#1416	M_wait[M191-160]	Special operation registration M code
		<p>Register an M code (160 to 191) that needs special operation.</p> <p>Each bit of the set value corresponds to the M code number.</p> <p>(Example) To register M05, set 00000020 in #1411.</p> <p>(Note) Note that the registered M code operation varies according to M_mode (#1401).</p> <p><b>---Setting range---</b></p> <p>0 to FFFFFFFF</p> <p>Set this in hexadecimal format.</p>

	<b>#1417</b>	<b>M_wait[M223-192]</b>	<b>Special operation registration M code</b>
			Register an M code (192 to 223) that needs special operation. Each bit of the set value corresponds to the M code number. (Example) To register M05, set 00000020 in #1411. (Note) Note that the registered M code operation varies according to M_mode (#1401).
			<b>--Setting range--</b> 0 to FFFFFFFF Set this in hexadecimal format.
	<b>#1418</b>	<b>M_wait[M255-224]</b>	<b>Special operation registration M code</b>
			Register an M code (224 to 255) that needs special operation. Each bit of the set value corresponds to the M code number. (Example) To register M05, set 00000020 in #1411. (Note) Note that the registered M code operation varies according to M_mode (#1401).
			<b>---Setting range---</b> 0 to FFFFFFFF Set this in hexadecimal format.
	<b>#1419</b>	<b>M_wait[M287-256]</b>	<b>Special operation registration M code</b>
			Not used.
	<b>#1420</b>	<b>M_wait[M319-288]</b>	<b>Special operation registration M code</b>
			Not used.
	<b>#1421</b>	<b>M_wait[M351-320]</b>	<b>Special operation registration M code</b>
			Not used.
	<b>#1422</b>	<b>M_wait[M383-352]</b>	<b>Special operation registration M code</b>
			Not used.
	<b>#1423</b>	<b>M_wait[M415-384]</b>	<b>Special operation registration M code</b>
			Not used.
	<b>#1424</b>	<b>M_wait[M447-416]</b>	<b>Special operation registration M code</b>
			Not used.
	<b>#1425</b>	<b>M_wait[M479-448]</b>	<b>Special operation registration M code</b>
			Not used.
	<b>#1426</b>	<b>M_wait[M511-480]</b>	<b>Special operation registration M code</b>
			Not used.
<b>(PR)</b>	<b>#1427</b>	<b>RT2AftG1</b>	<b>RT2: Enable switching of acce/dece time constant after G1 interpolation</b>
			Not used.
<b>(PR)</b>	<b>#1428</b>	<b>RT2rst</b>	<b>RT2: Enable changing acce/dece time constant back when NC is reset</b>
			Not used.
<b>(PR)</b>	<b>#1431</b>	<b>Ax_Chg</b>	<b>Selection of mixed control (cross axis control) or arbitrary axis exchange control</b>
			Choose which of the following controls to enable; Mixed control (Cross axis control) I, II or arbitrary axis exchange control. 0: Mixed control (Cross axis control) I or II 1: Arbitrary axis exchange control

#1432	Ax_Chg_Spec	
	<b>bit0: Selection of alarm when axis exchange is disabled</b>	
	Select whether to issue an alarm or wait until the axis becomes exchangeable when axis exchange is disabled.	
	0: Wait until the axis becomes exchangeable when the axis declared in an axis exchange command is incapable of being exchanged.	
	* The parameter #1433 (G140TimeOut) determines the operation to be carried out during the waiting time.	
	1: Output the alarm (M01 1101) when the axis declared in an axis exchange command is incapable of being exchanged.	
	<b>bit1: Compensation cancel after arbitrary axis exchange</b>	
	Select whether to enable canceling of compensation after an arbitrary axis exchange.	
	0: Not cancel compensation after arbitrary axis exchange	
	1: Cancel compensation after arbitrary axis exchange	
#1433	G140TimeOut	G140 timeout period
	Specify a period of time to wait before outputting the alarm (M01 1101) when an axis declared in the axis exchange command is unexchangeable.	
	If the specified time elapses with the axis remaining unexchangeable, the alarm (M01 1101) is output. However this alarm is cancelled and axis exchange is carried out once the axis becomes capable of being exchanged.	
	0 to 254: Period of time to wait before timeout (sec)	
	255: Wait until the axis becomes exchangeable without executing timeout check	
	(Note) This parameter is enabled when the alarm is not caused by an axis' unexchangeable state (when #1432 Ax_Chg_Spec(bit0) = 0).	
	<b>---Setting range---</b>	
	0 to 254 (s)	
	255: No timeout	
#1434	G140Type2	G140 command type 2
	Select which axis address(es) can be commanded under G140 (Arbitrary axis exchange) control.	
	0: The axis (or axes) specified in the G140 block can be commanded.	
	1: Not only the axis (or axes) specified in the G140 block but those unspecified in the block can also be commanded.	
#1435	crsman	Manual interruption during cross machining
	Select whether to enable manual interruption for an axis being under cross machining control.	
	0: Disable	
	1: Enable	
#1436	mstsyn	Enable override for dwell and miscellaneous function time
	Select whether to enable override for the dwell time and miscellaneous function time.	
	0: Disable (Override takes no effect.)	
	1: Enable (Override takes effect.)	
#1437	SBS2_Spec	Selection of alarm when sub part system II start is disabled
	<b>bit0: Selection of alarm when sub part system II start is disabled</b>	
	Select the type of operation to be carried out when the sub part system specified by G144 is incapable of being activated.	
	0: Wait until the system becomes capable of being activated	
	1: Output an alarm	
	<b>bit1: Sub part system control II: Reset type selection</b>	
	Select how to reset the sub part system control II.	
	0: Reset sub part system at the same time as main part system reset.	
	1: Not reset sub part system at the time of main part system reset.	

<b>(PR)</b>	<b>#1438</b>	<b>Ofs-SysAssign</b>	<b>Enable part system allocation of tool offset sets</b>
			Not used. Set to "0".
<b>(PR)</b>	<b>#1439</b>	<b>Tlife-SysAssign</b>	<b>Part system allocation of life management tools</b>
			Select the allocation method of the life management tools. 0: Automatic equal allocation 1: Arbitrary allocation  The setting of "1" is enabled for a system configured with two or more part systems. When "1" is selected for a system configured with a single part system, all the life management tools of the system are allocated to the 1st part system.
<b>(PR)</b>	<b>#1440</b>	<b>multi_sp_syn</b>	<b>Multiple spindle synchronization valid</b>
			Select whether to enable multiple spindle synchronization. 0: Disable multiple spindle synchronization. 1: Enable multiple spindle synchronization.
<b>(PR)</b>	<b>#1441</b>	<b>Tcode_Method_Chg</b>	<b>T command method selection</b>
			Select the tool command method. 0: Tool life management II format 1: Tool function
	<b>#1442</b>	<b>G00l</b>	<b>Enable G00 rapid traverse block overlap</b>
			Select whether to enable the G00 rapid traverse block overlap function. 0: Disable 1: Enable
	<b>#1443</b>	<b>G28ol</b>	<b>Enable G28 rapid traverse block overlap</b>
			Select whether to enable the G28 rapid traverse block overlap function. 0: Disable 1: Enable
	<b>#1444</b>	<b>otsys</b>	<b>Stop all part systems at OT</b>
			Select whether to stop all the part systems or only the part system where H/W stroke end, soft limit or interference check alarm has occurred.  (Note) If H/W stroke end, soft limit or interference check alarm has occurred on an axis related to superimposition, synchronization, arbitrary axis superimposition, or synchronization during axis traveling, the part system to which the superimposition (synchronous) and reference axes belong is treated as the one where the alarm has occurred.  0: Stop each part system 1: Stop all the part systems
<b>(PR)</b>	<b>#1445</b>	<b>Tol-Custom-nondisp</b>	<b>Non-display of additional info on tool management screen</b>
			Select whether to display or hide additional information on the tool management screen. 0: Display 1: Not display
	<b>#1446</b>	<b>Tino.hold</b>	<b>Tool length offset No. retention</b>
			Select the operation to be performed when command T has no tool length offset No. 0: Tool length offset No. is deemed as 0. 1: Last commanded tool length offset No. is applied. (Tool length offset No. is unchanged.)
	<b>#1447</b>	<b>G96_tmp_cancel</b>	<b>Temporary cancel of constant surface speed control</b>
			0: Disable a spindle rotation command given in another part system 1: Enable a spindle rotation command given in another part system
	<b>#1448</b>	<b>Scclamp_err_cancel</b>	<b>Cancel of the error for absence of spindle speed clamp</b>
			0: Disable cancel of the error 1: Enable cancel of the error

#1449	<b>m_clamp_on</b>	<b>Manual feed rate clamp ON</b>
	<p>0: Rapid traverse rate (#2001 rapid) serves as the maximum speed in jog, handle, incremental or manual reference position return (high-speed) mode. However you can use a PLC device to switch the maximum speed to the manual feed clamp speed (#2614 m_clamp).</p> <p>1: Manual feed clamp speed (#2614 m_clamp) serves as the maximum speed in jog, handle, incremental, or manual reference position return (high-speed) mode.</p>	
(PR) #1450	<b>5axis_Spec</b>	
	<b>bit0: Axis name setting method of rotary axis configuration parameter</b>	
	<p>Select the axis name setting method for rotary axis configuration parameter (#7900, #7901, #7902, #7922, #7932, #7942, #7952).</p> <p>0: Set by axis name</p> <p>1: Set by 2nd axis name</p>	
	<b>bit1: Using G174 tool axis rotation angle as compensation amount</b>	
	<p>0: Specify the compensation amount using the address R and R register.</p> <p>1: Use the tool axis rotation angle of G174 as the compensation amount.</p>	
	<b>bit2: Application of rotary axis configuration parameters</b>	
	<p>Select the method of applying the rotary axis configuration parameters.</p> <p>0: Automatic selection method</p> <p>1: PLC signal method</p> <p>(Note) This parameter is enabled when "#1450 5axis_Spec/bit0 (Axis name setting method of rotary axis configuration parameter)" is "1".</p>	
#1451	<b>M[M031-000](SMLK)</b>	<b>Special operation registration M code (High-speed simple program check)</b>
	<p>Register an M code to be output during high-speed simple program check.</p> <p>Each bit of the set value corresponds to the M code number.</p> <p>(Example) To register M05, set 00000020 in #1451.</p> <p>Note that operation of the registered M code varies according to #1405 M_mode(SMLK).</p> <p><b>---Setting range---</b></p> <p>0 to FFFFFFFF</p> <p>Set this in hexadecimal format.</p>	
#1452	<b>M[M063-032](SMLK)</b>	<b>Special operation registration M code (High-speed simple program check)</b>
	<p>Register an M code to be output during high-speed simple program check.</p> <p>Each bit of the set value corresponds to the M code number.</p> <p>(Example) To register M05, set 00000020 in #1451.</p> <p>Note that operation of the registered M code varies according to #1405 M_mode(SMLK).</p> <p><b>---Setting range---</b></p> <p>0 to FFFFFFFF</p> <p>Set this in hexadecimal format.</p>	
#1453	<b>M[M095-064](SMLK)</b>	<b>Special operation registration M code (High-speed simple program check)</b>
	<p>Register an M code to be output during high-speed simple program check.</p> <p>Each bit of the set value corresponds to the M code number.</p> <p>(Example) To register M05, set 00000020 in #1451.</p> <p>Note that operation of the registered M code varies according to #1405 M_mode(SMLK).</p> <p><b>---Setting range---</b></p> <p>0 to FFFFFFFF</p> <p>Set this in hexadecimal format.</p>	

<b>#1454</b>	<b>M[M127-096](SMLK)</b>	<b>Special operation registration M code (High-speed simple program check)</b>
<p>Register an M code to be output during high-speed simple program check.  Each bit of the set value corresponds to the M code number.  (Example) To register M05, set 00000020 in #1451.  Note that operation of the registered M code varies according to #1405 M_mode(SMLK).</p> <p><b>---Setting range---</b>  0 to FFFFFFFF  Set this in hexadecimal format.</p>		
<b>#1455</b>	<b>M[M159-128](SMLK)</b>	<b>Special operation registration M code (High-speed simple program check)</b>
<p>Register an M code to be output during high-speed simple program check.  Each bit of the set value corresponds to the M code number.  (Example) To register M05, set 00000020 in #1451.  Note that operation of the registered M code varies according to #1405 M_mode(SMLK).</p> <p><b>---Setting range---</b>  0 to FFFFFFFF  Set this in hexadecimal format.</p>		
<b>#1456</b>	<b>M[M191-160](SMLK)</b>	<b>Special operation registration M code (High-speed simple program check)</b>
<p>Register an M code to be output during high-speed simple program check.  Each bit of the set value corresponds to the M code number.  (Example) To register M05, set 00000020 in #1451.  Note that operation of the registered M code varies according to #1405 M_mode(SMLK).</p> <p><b>---Setting range---</b>  0 to FFFFFFFF  Set this in hexadecimal format.</p>		
<b>#1457</b>	<b>M[M223-192](SMLK)</b>	<b>Special operation registration M code (High-speed simple program check)</b>
<p>Register an M code to be output during high-speed simple program check.  Each bit of the set value corresponds to the M code number.  (Example) To register M05, set 00000020 in #1451.  Note that operation of the registered M code varies according to #1405 M_mode(SMLK).</p> <p><b>---Setting range---</b>  0 to FFFFFFFF  Set this in hexadecimal format.</p>		
<b>#1458</b>	<b>M[M255-224](SMLK)</b>	<b>Special operation registration M code (High-speed simple program check)</b>
<p>Register an M code to be output during high-speed simple program check.  Each bit of the set value corresponds to the M code number.  (Example) To register M05, set 00000020 in #1451.  Note that operation of the registered M code varies according to #1405 M_mode(SMLK).</p> <p><b>---Setting range---</b>  0 to FFFFFFFF  Set this in hexadecimal format.</p>		

<b>#1459</b>	<b>M[M287-256](SMLK)</b>	<b>Special operation registration M code (High-speed simple program check)</b>
<p>Register an M code to be output during high-speed simple program check.  Each bit of the set value corresponds to the M code number.  (Example) To register M05, set 00000020 in #1451.  Note that operation of the registered M code varies according to #1405 M_mode(SMLK).</p> <p><b>---Setting range---</b>  0 to FFFFFFFF  Set this in hexadecimal format.</p>		
<b>#1460</b>	<b>M[M319-288](SMLK)</b>	<b>Special operation registration M code (High-speed simple program check)</b>
<p>Register an M code to be output during high-speed simple program check.  Each bit of the set value corresponds to the M code number.  (Example) To register M05, set 00000020 in #1451.  Note that operation of the registered M code varies according to #1405 M_mode(SMLK).</p> <p><b>---Setting range---</b>  0 to FFFFFFFF  Set this in hexadecimal format.</p>		
<b>#1461</b>	<b>M[M351-320](SMLK)</b>	<b>Special operation registration M code (High-speed simple program check)</b>
<p>Register an M code to be output during high-speed simple program check.  Each bit of the set value corresponds to the M code number.  (Example) To register M05, set 00000020 in #1451.  Note that operation of the registered M code varies according to #1405 M_mode(SMLK).</p> <p><b>---Setting range---</b>  0 to FFFFFFFF  Set this in hexadecimal format.</p>		
<b>#1462</b>	<b>M[M383-352](SMLK)</b>	<b>Special operation registration M code (High-speed simple program check)</b>
<p>Register an M code to be output during high-speed simple program check.  Each bit of the set value corresponds to the M code number.  (Example) To register M05, set 00000020 in #1451.  Note that operation of the registered M code varies according to #1405 M_mode(SMLK).</p> <p><b>---Setting range---</b>  0 to FFFFFFFF  Set this in hexadecimal format.</p>		
<b>#1463</b>	<b>M[M415-384](SMLK)</b>	<b>Special operation registration M code (High-speed simple program check)</b>
<p>Register an M code to be output during high-speed simple program check.  Each bit of the set value corresponds to the M code number.  (Example) To register M05, set 00000020 in #1451.  Note that operation of the registered M code varies according to #1405 M_mode(SMLK).</p> <p><b>---Setting range---</b>  0 to FFFFFFFF  Set this in hexadecimal format.</p>		

	<b>#1464</b>	<b>M[M447-416](SMLK)</b>	<b>Special operation registration M code (High-speed simple program check)</b>
	<p>Register an M code to be output during high-speed simple program check.  Each bit of the set value corresponds to the M code number.  (Example) To register M05, set 00000020 in #1451.  Note that operation of the registered M code varies according to #1405 M_mode(SMLK).</p> <p><b>---Setting range---</b>  0 to FFFFFFFF  Set this in hexadecimal format.</p>		
	<b>#1465</b>	<b>M[M479-448](SMLK)</b>	<b>Special operation registration M code (High-speed simple program check)</b>
	<p>Register an M code to be output during high-speed simple program check.  Each bit of the set value corresponds to the M code number.  (Example) To register M05, set 00000020 in #1451.  Note that operation of the registered M code varies according to #1405 M_mode(SMLK).</p> <p><b>---Setting range---</b>  0 to FFFFFFFF  Set this in hexadecimal format.</p>		
	<b>#1466</b>	<b>M[M511-480](SMLK)</b>	<b>Special operation registration M code (High-speed simple program check)</b>
	<p>Register an M code to be output during high-speed simple program check.  Each bit of the set value corresponds to the M code number.  (Example) To register M05, set 00000020 in #1451.  Note that operation of the registered M code varies according to #1405 M_mode(SMLK).</p> <p><b>---Setting range---</b>  0 to FFFFFFFF  Set this in hexadecimal format.</p>		
	<b>#1467</b>	<b>Manual MSTB macro</b>	<b>MSTB macro call via manual numerical value command</b>
	Not used.		
	<b>#1468</b>	<b>ctrl period</b>	<b>Control period</b>
	Not used.		
<b>(PR)</b>	<b>#1471</b>	<b>mgramstp</b>	<b>Enable machine groupwise alarm stop</b>
	<p>Select whether to enable the machine groupwise alarm stop function.  0: Disable  1: Enable</p>		
<b>(PR)</b>	<b>#1472</b>	<b>mgramrestart</b>	<b>Allowing automatic operation to start after machine groupwise alarm stop</b>
	<p>Select whether to allow automatic operation to be activated after machine groupwise alarm stop.  0: Not allow automatic operation to start after machine groupwise alarm stop  1: Allow automatic operation to start after machine groupwise alarm stop</p>		
<b>(PR)</b>	<b>#1473</b>	<b>mgramcont</b>	<b>Allowing operation to continue after machine groupwise alarm stop</b>
	<p>When any alarm causes an axis that is in the midst of program execution to stop, this parameter allows you to select the behavior of axes that belong to machine groups other than that of the said axis.  0: Feed hold  1: The operation is allowed to continue.</p>		



(PR)	#1474	SBS2_sys num	Number of sub systems to use in sub part system control II
Specify the number of sub part systems to use in sub part system control II.			
The specified number of part systems counted from the end of the system's effective part systems are treated as sub part systems.			
---Setting range---			
0 to 7			
(PR)	#1475	MES-IF_on	MES-IF ON
Set whether to enable the MES interface function.			
0: Disable			
1: Enable			
	#1476	ComErrDly	Delayed display of communication alarm
Specify a period of time by which to delay the alarm display and record to the alarm history, when the communication error (Y02 0051) occurs. Set this time when a communication error is caused at power OFF. If it does not occur (if unused), set to 0.			
---Setting range---			
0 to 5000 (ms)			
	#1477	SrvAlmDly	Delayed display of servo alarm
Specify a period of time by which to delay the alarm display and record to the alarm history, when a servo/spindle alarm occurs. Set this time when a servo/spindle alarm is caused at power OFF. If it does not occur (if unused), set to 0.			
---Setting range---			
0 to 5000 (ms)			
(PR)	#1480	tp_invalid	Disable touch panel operation
Select whether to disable input via touch panel.			
0: Enable touch panel operation			
1: Disable touch panel operation			
(PR)	#1481	Enable S-Safety	Enable smart safety observation
Select whether to enable smart safety observation.			
0: Disable			
1: Enable			
(PR)	#1483	SBS1_sys num	Number of sub systems to use in sub part system control I
Specify the number of sub part systems to be used for Sub part system control I. The specified number of part systems counted from the end of the system's effective part systems are treated as sub part systems.			
---Setting range---			
0 to 2			
	#1487	ITF3_Spec	Interference check III specification
Not used.			
(PR)	#1488	ITF3 valid	Interference check III valid
Not used.			
(PR)	#1489	SLMP_on	SLMP_on
Not used.			

	<b>#1701</b>	<b>cfg01</b>	
			<b>bit3: Operation with #50000 variables</b>
			Specify how to process read/write operation of #50000s variables via a machining program.
			0: Block by block
			1: Batch process with other macro statements. (conventional)
			<b>bit4: Macro single operation</b>
			Specify whether to enable parameter "#8101 MACRO SINGLE" in the continuous operation mode.
			0: Enable "#8101 MACRO SINGLE" in the continuous operation mode. (conventional)
			1: Disable "#8101 MACRO SINGLE" in the continuous operation mode.
			<b>bit5: Behavior of overlapping for G1 command blocks</b>
			Select the overlapping behavior for consecutive G1 command blocks when MSTB command is included in the G1 block.
			0: While MSTB function strobe is ON, overlapping for consecutive G1 blocks is disabled.
			1: While MSTB function strobe is ON, overlapping for consecutive G1 blocks is enabled.
	<b>#1702-1725</b>	<b>cfg02-cfg25</b>	
			Not used. Set to "0".
<b>(PR)</b>	<b>#1751-1760</b>	<b>cfgPR01-cfgPR10</b>	
			Not used. Set to "0".
<b>(PR)</b>	<b>#1761</b>	<b>cfgPR11</b>	
			<b>bit2: Selection of trigger edge for Cycle start</b>
			Select the trigger edge of the Cycle start signal.
			0: Falling edge (from ON to OFF)
			1: Rising edge (from OFF to ON)
			<b>bit4: Direct transfer of spindle speed command data</b>
			Select the method of transferring the spindle speed command data to the "Spindle command rotation speed output" device.
			0: The spindle speed command data is transferred not from the NC but from the PLC. Thus a ladder that sets the rotation speed is required in the sequence program.
			1: The spindle speed command data output from the NC is directly transferred.
			<b>bit7: Enable change of current FB (load) output unit</b>
			Select whether to enable the change of units in which the current FB (load) is output to a register.
			When output in units of 0.01%, the output range is from 0 to 327.67%.
			0: Output in units of 0.01%.
			1: The unit is selected from 1% or 0.01% in accordance with the setting of "#1256 set28/bit2".
<b>(PR)</b>	<b>#1762-1775</b>	<b>cfgPR12-cfgPR25</b>	
			Not used. Set to "0".
	<b>#1925</b>	<b>EtherNet</b>	<b>Start of service</b>
			Start or stop the Ethernet communication function.
			0: Stop
			1: Start
<b>(PR)</b>	<b>#1926</b>	<b>Global IP address</b>	<b>IP address</b>
			Set the main CPU's IP address.
			Set the NC IP address seen from an external source.
			<b>---Setting range---</b>
			Set these parameters in accordance with the network rules in the connection environment.
<b>(PR)</b>	<b>#1927</b>	<b>Global Subnet mask</b>	<b>Subnet mask</b>
			Set the subnet mask for the IP address.
			<b>---Setting range---</b>
			Set these parameters in accordance with the network rules in the connection environment.

(PR)	#1928	<b>Global Gateway</b>	<b>Gateway</b>
		Set the IP address for the gateway.	
		<b>---Setting range---</b>	
		Set these parameters in accordance with the network rules in the connection environment.	
	<b>#1929</b>		
		Not used. Set to "0".	
	<b>#1930</b>		
		Not used. Set to "0".	
(PR)	#1931	<b>Host number</b>	<b>Host No.</b>
		Not used.	
(PR)	#1934	<b>Local IP address</b>	
		Not used.	
(PR)	#1935	<b>Local Subnet mask</b>	
		Not used.	
(PR)	#1953	<b>Intra IP address</b>	<b>IP address on non-Windows-based display unit (LAN1) side</b>
		Not used.	
(PR)	#1954	<b>Intra Subnet mask</b>	<b>Subnet mask on non-Windows-based display unit (LAN1) side</b>
		Not used.	
(PR)	#1955	<b>Intra Gateway</b>	<b>Gateway on non-Windows-based display unit (LAN1) side</b>
		Not used.	
(PR)	#11001	<b>APC type</b>	<b>APC screen display type selection</b>
		Not used. Set to "0".	
(PR)	#11002	<b>Valid pallet num</b>	<b>Number of pallets setting</b>
		Not used. Set to "0".	
(PR)	#11003	<b>APLC valid</b>	<b>APLC valid</b>
		Temporarily disable APLC. Normally set "1". 0: Disable 1: Enable	
(PR)	#11004	<b>PLCauto-run enable</b>	<b>PLC automatic startup valid</b>
		Not used.	
(PR)	#11005	<b>PC IP address</b>	<b>IP address setting</b>
		Not used.	
	<b>#11006</b>	<b>PC Port number</b>	<b>Port No. setting</b>
		Not used.	
(PR)	#11007	<b>PC Timeout</b>	<b>Communication timeout time setting</b>
		Not used.	
(PR)	#11009	<b>M2 label O</b>	<b>M2 label O</b>
		Select the program number label when using the M2 format. 0: Label L 1: Label O	

(PR)	#11010	Software keyboard	Software keyboard
		Select whether or not to use a software keyboard on a touchscreen. 0-1: Use (no automatic display) 2: Use (The keyboard appears automatically on a specific screen or upon Y/N confirmation) 3: Use (The keyboard appears automatically upon Y/N confirmation) 4: Use (S/W keyboard is switched to Y/N window upon Y/N confirmation)	
	#11011	Handy TERM. PW.	Handy terminal password
		Not used.	
(PR)	#11012	16 axes for 1ch	Connecting 16 axes for 1ch
		Select the maximum number of axes (sum of the NC axis, spindle, and PLC axis) connected to the drive unit interface (channel 1). 0: Up to 8 axes can be connected to channel 1. 1: Up to 16 axes can be connected to channel 1. This parameter is disabled when the extension unit is connected. It is possible to connect only up to eight axes or less per channel.	
	#11013	3D_MChk	Invalidate 3D machine interference check
		Not used. Set to "0".	
	#11014	Chk_len1	1st-step interference check distance
		Not used. Set to "0.000".	
	#11015	Chk_len2	2nd-step interference check distance
		Not used. Set to "0.000".	
	#11016	Expand_Rate	Shape expansion rate
		Not used. Set to "0".	
	#11017	T-ofs set at run	Tool compensation amount setting during automatic operation enabled
		Select whether to enable the tool compensation amount setting and life value setting during automatic operation and operation pause. 0: Disable 1: Enable	
	#11018	M password hold	Machine user password is held
		When set to "1", the "Machine user" (operation level 6) password will be held even if the NC is restarted. 0: Do not hold 1: Machine user password is held	
(PR)	#11019	2-system display	2-part system simultaneous display
		Select whether to enable simultaneous display of multiple part systems on the monitor screen. 0: Display one part system on the monitor screen. 1, 2: Display two part systems simultaneously on the monitor screen. (Note) If the number of part systems to display is smaller than that of the simultaneous display, a single part system display is selected.	
(PR)	#11020	Mcngit_Spec	Machining interruption specification
		<b>bit0: Restart after emergency stop</b> Select whether to enable/disable restart after emergency stop. 0: Disable 1: Enable (Note) When you select "Enable", the option for machining interruption function is needed.	
		<b>---Setting range---</b> 0000 to FFFF (hexadecimal)	

	<b>#11021</b>	<b>PLC mesg disp type</b>	<b>Format of PLC alarm and operator message</b>
			Select the format of PLC alarms and operator messages to be displayed on the bottom right of the screen. 0: Display up to the first 40 characters. 1: If text is longer than 40 characters, divide it into two and display separately. (Supplementary information is displayed together)
	<b>#11022</b>	<b>SRAM Output Type</b>	Not used. Set to "0".
	<b>#11023</b>	<b>G33.n Drn</b>	Not used. Set to "0".
	<b>#11024</b>	<b>G33.n fhd</b>	Not used. Set to "0".
	<b>#11028</b>	<b>Tolerance Arc Cent</b>	<b>Tolerable correction value of arc center error</b>
			Set the tolerable correction value for the calculated coordinate value error of R-specified circular center. When a difference between "a line between the start and end points" and "commanded radius x 2" is the tolerance or smaller, the error is corrected so that the middle of a line between the start and end points will be the arc center. When [Setting value < 0]: 0 (Not correct arc center error) When [Setting value = 0]: 2 x minimum setting increment When [Setting value > 0]: Setting value <b>---Setting range---</b> <Metric system> -1 to 0.100 (mm) <Inch system> -0.0393 to 0.0039 (inch)
	<b>#11029</b>	<b>Arc to G1 no Cent</b>	<b>Change command from arc to linear when no arc center designation</b>
			When arc center or radius designation is omitted from arc command, change the arc command into linear without causing program error. 0: Program error 1: Change into linear command
	<b>#11030</b>	<b>Man tap sync cancel</b>	<b>Synchronization cancel in manual synchronous tapping</b>
			Select whether handle feed of the tapping axis in manual synchronous tapping synchronizes with the spindle or not. 0: Synchronize with the spindle 1: Not synchronize with the spindle
<b>(PR)</b>	<b>#11031</b>	<b>Cursor pos search</b>	<b>Cursor position search</b>
			Select the cursor position searching method. 0: Disable 1: Pressing the INPUT key in [Monitr] - [Edit] menu starts the operation search for the block with the cursor. 2: Turning ON/OFF the "Edit/Search" signal in [Monitr] - [Edit] menu starts the operation search for the block with the cursor. 3: Turning ON/OFF the "Edit/Search" signal in [Monitr] - [Edit] menu starts the operation search for the block with the cursor. Pressing the reset key shows the top of the program on the [Edit/Search] window.
<b>(PR)</b>	<b>#11032</b>	<b>Menu sel para lkof</b>	<b>Validate menu selection parameter setting</b>
			Select whether to enable the setting of the "menu selection parameters" (#10501 to #10530, #10551 to #10580, and #10601 to #10630), with which the order of main menus on Monitor, Setup and Edit screens can be rearranged. And also select who is allowed to do this setting. 0: Disable 1: Enable (machine tool builder password is required) 2: Enable (users are allowed to set)

<b>(PR)</b>	<b>#11033</b>	<b>skipB_no_sens</b>	<b>Unconnected sensor selection when skip is set to contact B</b>
			<p>Select the contact of the sensor which you wish to set as unconnected, when the skip signal is set to contact B. Set "1" for the contact to be unconnected.</p> <p>bit0: Skip input 1 bit1: Skip input 2 bit2: Skip input 3 bit3: Skip input 4 bit4: Skip input 5 bit5: Skip input 6 bit6: Skip input 7 bit7: Skip input 8</p> <p>(Note 1) This parameter is enabled when "#1258 set30/bit0" is set to "1". (Note 2) This parameter is independent of PLC skip.</p> <p><b>---Setting range---</b> 00000000 to 11111111 (Binary)</p>
	<b>#11034</b>	<b>G12AddrCheckType</b>	<b>Command address type to check in circular cutting</b>
			<p>Select the type of command address to check in circular cutting.</p> <p>0: Regard command addresses other than D, F, I as illegal. 1: Regard the command address H as illegal. And commands other than D,F,I and M,S,T,B are disabled.</p>
	<b>#11035</b>	<b>Sys. change limit</b>	<b>Part system switching restriction</b>
			<p>This restricts switching the part systems displayed on screen.</p> <p>0: Not restrict 1: Disable the part system switching by pressing [\$&lt;-&gt;\$] key on touch panel. 2: Disable the part system switching by display switch signals(Y730 to Y733).</p>
	<b>#11036</b>	<b>meas dir judge</b>	<b>Non-sensitive band for manual measurement direction judgment (for M system only)</b>
			<p>Set the non-sensitive band to be used for judging the manual measurement direction. If the feedback position fluctuates widely at the axis stop, set the fluctuation width or larger value in this set the parameter. When set to "0", the band will be 1 (μm).</p> <p><b>---Setting range---</b> 0 to 1000 (μm) 0: 1 (μm)</p>
	<b>#11037</b>	<b>R-Navi Index Type</b>	<b>R-Navi machining surface indexing type</b>
			Not used.
	<b>#11038</b>	<b>T disp typ</b>	<b>T display (tool command value) type (For L system only)</b>
			<p>Select the T display (tool command value) type on the monitor screen between displaying tool No. only or displaying tool No. and compensation No. (L system only)</p> <p>0: Display tool No. only 1: Display the tool command value (the combined value consisting of the tool No. and compensation No.) last commanded by the program. Even in a manual value command, the program's tool command value is displayed.</p>
	<b>#11039</b>	<b>Cusr pos srch type</b>	<b>Cursor position search type</b>
			<p>Set the availability of the cursor position search during single block stop when "#11031 Cursor pos search" is any of "1" to "3".</p> <p>0: Disable cursor position search during single block stop. 1: Enable cursor position search during single block stop. Sub-program is displayed when selecting menus [Monitr]-[Edit] while single block stop is carried out during sub-program with this parameter set to 1.</p>

	<b>#11051</b>	<b>Direct Socket ON</b>	<b>Direct Socket communication I/F ON</b>
	Not used.		
	<b>#11052</b>	<b>LOG Sort Order</b>	<b>Log data sorting order</b>
	Select in which order to sort the operation log files (all logs) to be output. 0: Sort the data in chronologically ascending order separately for each log type. 1: Sort the data in chronologically ascending order for all the log types. If the times and dates logged are identical, the log files are output in the order of key, touchscreen, alarm, PLC signal, tool offset change, workpiece offset change and AC power.		
	<b>#11054</b>	<b>Sp-stby disp type</b>	<b>Spindle-standby display type</b>
	Specify which magazine to display when Sp-stby is selected on the Spindle standby or Tool registration screen. 0: Fixed to the magazine #1 1: The magazine selected by the menu (Magazine 1 to Magazine 5).		
	<b>#11055</b>	<b>Disp. sysno</b>	<b>Number of part systems to display</b>
	Specify how many part systems to display on a screen. 0: The same number as that of the enabled part systems 1 or greater: The number specified by this parameter serves as that of the part systems to display. (Note) The setting range differs according to the NC model. For the number of part systems displaying in the operating state, follow this parameter setting. ---Setting range--- 0 to 8		
(PR)	<b>#11056</b>	<b>Workshift invalid</b>	<b>Workpiece coordinate system shift OFF (For L system only)</b>
	Set this parameter to 1 if you wish to disable the workpiece coordinate system shift function. 0: Enable the workpiece coordinate shift function 1: Disable the workpiece coordinate shift function		
(PR)	<b>#11058</b>	<b>plc_opemsg0</b>	<b>Operator messages display device</b>
	Not used.		
(PR)	<b>#11059</b>	<b>Remote comm enable</b>	<b>Remote connect enabled</b>
	Not used.		
(PR)	<b>#11060</b>	<b>Screen theme color</b>	<b>Select screen theme colors</b>
	Select the screen theme colors. This selection affects the colors of the entire screen. 0: Standard colors (gray tone) 1: Blue tone		
(PR)	<b>#11061</b>	<b>Num of EcoMonitors</b>	<b>The Number of EcoMonitorLight connected to CNC</b>
	Not used.		
(PR)	<b>#11062-11066</b>	<b>NoHistDevIn.1-5</b>	<b>History exclusion PLC input signal 1 to 5</b>
	Specify the PLC input signal (X) that is excluded from the PLC signal log. Efficiency of the history analysis is improved by excluding the machine contact input/output signals or other frequently switched signals from the signal log. When "0" is set, the history exclusion PLC input signal is disabled. Thus X0 cannot be excluded from the signal log. ---Setting range--- 0000 to 1FFF		

(PR)	#11067-11071	NoHistDevOut.1-5	History exclusion PLC output signal 1 to 5
<p>Specify the PLC output signal (Y) that is excluded from the PLC signal log. Efficiency of the history analysis is improved by excluding the machine contact input/output signals or other frequently switched signals from the signal log. When "0" is set, the history exclusion PLC output signal is disabled. Thus Y0 cannot be excluded from the signal log.</p> <p>---Setting range---</p> <p>0000 to 1FFF</p>			
(PR)	#11080	HomeScreen display	HomeScreen display
Not used.			
(PR)	#11082	Lsys_change_Gtype	L system G code system after program format switch (for M system only)
Not used.			
	#11086	rot_angle_dsp	Counter display during coordinate rotation
<p>Select the type of counter display (workpiece coordinate position, relative position and absolute position) while #8116 is 0 (coordinate rotation by parameter is enabled).</p> <p>0: Display the position relative to the orthogonal coordinate system.</p> <p>1: Display the position relative to the coordinate system rotated through the coordinate rotation by parameter. (with EXT [external workpiece coordinate offset] added during automatic operation)</p> <p>2: Display the position relative to the coordinate system rotated through the coordinate rotation by parameter. (with EXT [external workpiece coordinate offset] constantly added)</p>			
(PR)	#11087	Meas basic point	Tool length measurement I reference point (for L system only)
<p>Select how to specify the measurement reference point coordinates for manual tool length measurement I (L system).</p> <p>0: Use the machine zero point as the reference point</p> <p>1: Use the coordinates of "#2015 tml-" as the reference point (the same operation as when #1282 bit2 = 0 for M7)</p> <p>2: Use the workpiece coordinate system offset (modal) as the reference point (the same operation as when #1282 bit2 = 1 for M7)</p>			
(PR)	#11101-11130	Monitr menu(MTB)1-30	Monitor main menu (MTB) 1 to 30
<p>Designate the destination menu Nos. to move monitor screen's main menus.</p> <p>-1: Menu not displayed</p> <p>0: No change</p> <p>1 to 30: Destination menu No.</p>			
(PR)	#11151-11180	Setup menu (MTB) 1-30	Setup main menu (MTB) 1 to 30
<p>Designate the destination menu Nos. to move setup screen's main menus.</p> <p>-1: Menu not displayed</p> <p>0: No change</p> <p>1 to 30: Destination menu No.</p>			
(PR)	#11201-11230	Edit menu(MTB) 1-30	Edit main menu (MTB) 1 to 30
<p>Designate the destination menu Nos. to move edit screen's main menus.</p> <p>-1: Menu not displayed</p> <p>0: No change</p> <p>1 to 30: Destination menu No.</p>			



(PR)	#11251- 11280	Diagn menu(MTB)1-30	Diagn main menu (MTB) 1 to 30
	Designate the destination menu Nos. to move diagn screen's main menus. -1 : Not display the menu 0: No change 1 to 30: Destination menu No.		
(PR)	#11301- 11330	Mainte menu(MTB)1-30	Mainte main menu (MTB) 1 to 30
	Designate the destination menu Nos. to move mainte screen's main menus. -1 : Not display the menu 0: No change 1 to 30: Destination menu No.		
(PR)	#11746	H4_pno	4th handle selection
	Specify the connection destination of the 4th handle. (The following setting values are same as those of the 1st to 3rd handle selection.) bit0 to bit3: Connection channel bit4 to bit7: Handle-connected CNC CPU module Setting value 0001: Host CNC CPU 1CH 0002: Host CNC CPU 2CH 0003: Host CNC CPU 3CH 0031: CNC CPU No. 2 1CH 0032: CNC CPU No. 2 2CH 0033: CNC CPU No. 2 3CH 0041: CNC CPU No. 3 1CH 0042: CNC CPU No. 3 2CH 0043: CNC CPU No. 3 3CH 0051: CNC CPU No. 4 1CH 0052: CNC CPU No. 4 2CH 0053: CNC CPU No. 4 3CH (Note 1) When the specified destination is not implemented, handle movement is not performed. (Note 2) When all the "H1_pno" to "H9_pno" are set to "0000", handles are automatically allocated. In case of arbitrary assignment, set "0000" for the handles which have not been assigned yet. (Note 3) The values set in bit8 to bitF are ignored. ---Setting range--- 0x0000 to 0xFFFF		
(PR)	#11747	H5_pno	5th handle selection
	Set the connection destination of the 5th handle. Refer to "#11746 H4_pno" (4th handle selection) for further details.		
(PR)	#11748	H6_pno	6th handle selection
	Set the connection destination of the 6th handle. Refer to "#11746 H4_pno" (4th handle selection) for further details.		
(PR)	#11749	H7_pno	7th handle selection
	Set the connection destination of the 7th handle. Refer to "#11746 H4_pno" (4th handle selection) for further details.		
(PR)	#11750	H8_pno	8th handle selection
	Set the connection destination of the 8th handle. Refer to "#11746 H4_pno" (4th handle selection) for further details.		
(PR)	#11751	H9_pno	9th handle selection
	Set the connection destination of the 9th handle. Refer to "#11746 H4_pno" (4th handle selection) for further details.		

#11760	MKT_Rate	Threshold percentage for monitoring coil switch duration
		Specify the alarm threshold to be applied to the monitoring of the coil switch duration. The threshold is defined as a percentage (%) of the time set in "#13114 SP114" (Coil switch gate cutoff timer). When "0" is set, the coil switch duration is not monitored.
		---Setting range--- 0 to 100 (%)
(PR) #26750	CPUUnitNum	Number of CPU modules
		Specify the number of CPU modules that configure a multiple CPU system. When set to "0", the number of CPU modules is considered as 2. (Note) Set the identical value for all the CPU modules.
		---Setting range--- 0 to 4 (units)
(PR) #26751	DevCondenseRef	Compressed device refresh ON
		Select whether to use the compression setting for the R devices refreshed at END in such a case as when a system is configured with 3 CNC modules.
		0: Not use 1: Use

## 16.4 Axis Specifications Parameters

#2001	rapid	Rapid traverse rate
		Set the rapid traverse feedrate for each axis. (Note) The maximum value to be set depends on the machine specifications.
		---Setting range---
		1 to 1000000 (mm/min)
#2002	clamp	Cutting feedrate for clamp function
		Set the maximum cutting feedrate for each axis. Even if the feedrate in G01 exceeds this value, the clamp will be applied at this feedrate.
		---Setting range---
		1 to 1000000 (mm/min)

**(PR) #2003 smgst Acceleration and deceleration modes**

Set acceleration and deceleration control modes.  
Set value is in hexadecimal.

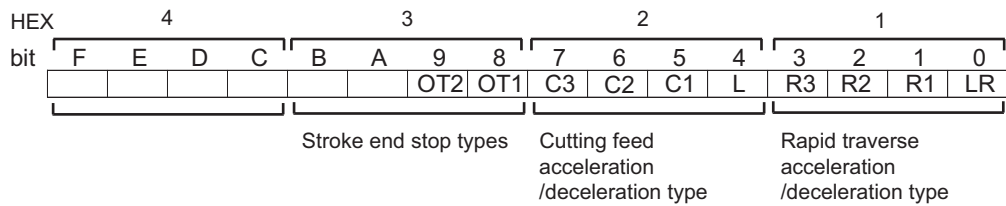

**HEX-1 Rapid traverse acceleration/deceleration type**

- 0 (bit3,2,1,0 = 0000): Step
- 1 (bit3,2,1,0 = 0001): Linear acceleration/deceleration
- 2 (bit3,2,1,0 = 0010): Primary delay
- 8 (bit3,2,1,0 = 1000): Exponential acceleration and linear deceleration
- F (bit3,2,1,0 = 1111): Soft acceleration/deceleration

(Note) Primary delay is applied because R1 setting has priority over R3 setting when R1 and R3 are both set to "1".

**HEX-2 Cutting feed acceleration/deceleration type**

- 0 (bit7,6,5,4 = 0000): Step
- 1 (bit7,6,5,4 = 0001): Linear acceleration/deceleration
- 2 (bit7,6,5,4 = 0010): Primary delay
- 8 (bit7,6,5,4 = 1000): Exponential acceleration and linear deceleration
- F (bit7,6,5,4 = 1111): Soft acceleration/deceleration

**HEX-3 Stroke end stop types**

- 0 (bit9,8 = 00): Linear deceleration (Decelerates at G0t1)
- 1 (bit9,8 = 01): Linear deceleration (Decelerates at 2xG0t1)
- 2 (bit9,8 = 10): Position loop step stop
- 3 (bit9,8 = 11): Position loop step stop

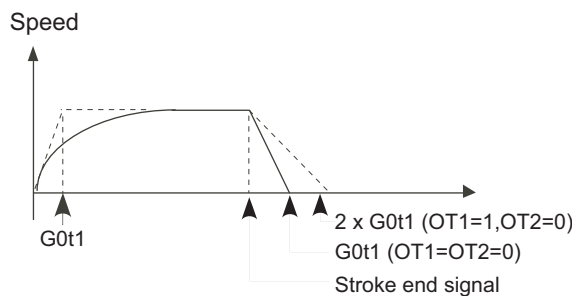

(Note) OT1(bit8) is valid under the following conditions (valid for dog type zero point return):  
 - Stop type: Linear deceleration  
 - Acceleration/deceleration mode: Exponential Acceleration and Linear deceleration

**HEX-4**

Not used. Set to "0".

#2004

G0tL

G0 time constant (linear)

Set a linear control time constant for rapid traverse acceleration and deceleration.

This time constant is enabled when LR (rapid traverse feed with linear acceleration/deceleration) or F (soft acceleration/deceleration) is selected in "#2003 smgst" (Acceleration and deceleration modes).

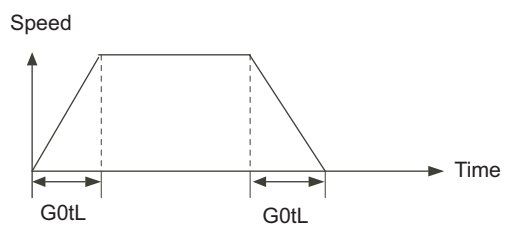

---Setting range---

1 to 4000 (ms)

#2005

G0t1

G0 time constant(primary delay) / Second-step time constant for soft acceleration/deceleration

Set a primary-delay time constant for rapid traverse acceleration and deceleration.

This time constant is enabled when R1 (rapid traverse feed with primary delay) or R3 (exponential acceleration and linear deceleration) is selected in "#2003 smgst" (Acceleration and deceleration modes).

When the soft acceleration/deceleration is selected, the second-step time constant will be used.

<Rapid traverse feed with primary delay>

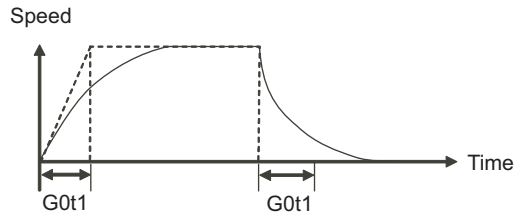

<Rapid traverse feed with exponential acceleration and linear deceleration>

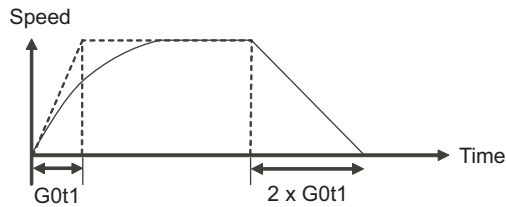

<Soft acceleration/deceleration>

◆When "#1219 aux03/bit7" is set to "0"

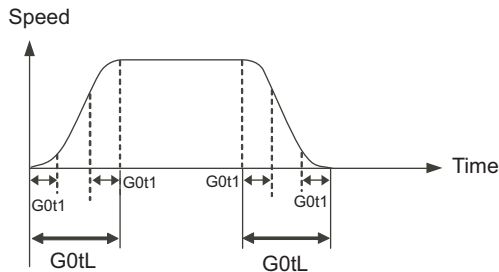

(Note) The time constant setting for the soft acceleration/deceleration can be changed by the setting of "#1219 aux03/bit7"

---Setting range---

1 to 5000 (ms)

#2006

G0t2

Not used. Set to "0".

<b>#2007</b>	<b>G1tL</b>	<b>G1 time constant (linear)</b>
--------------	-------------	----------------------------------

Set a linear control time constant for cutting acceleration and deceleration.

The time constant will be enabled when LC (cutting feed with linear acceleration/deceleration) or F (soft acceleration/deceleration) is selected in "#2003 smgst" (Acceleration or deceleration modes).

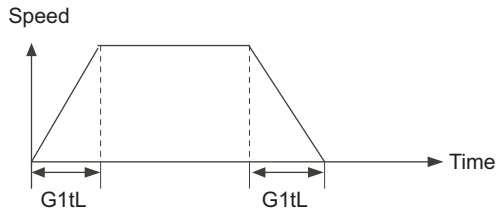

**---Setting range---**

1 to 4000 (ms)

<b>#2008</b>	<b>G1t1</b>	<b>G1 time constant (primary delay)/Second-step time constant for soft acceleration/deceleration</b>
--------------	-------------	--

Set the primary delay time constant for cutting acceleration and deceleration.

The time constant will be enabled when C1 (cutting feed with the primary delay) or C3 (cutting feed with exponential acceleration and linear deceleration) is selected in "#2003 smgst" (Acceleration/deceleration modes).

When the soft acceleration/deceleration is selected, the second-step time constant will be used.

<Cutting feed with primary delay>

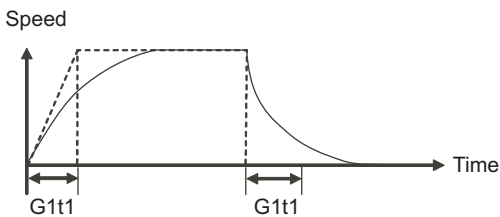

<Cutting feed with exponential acceleration and linear deceleration>

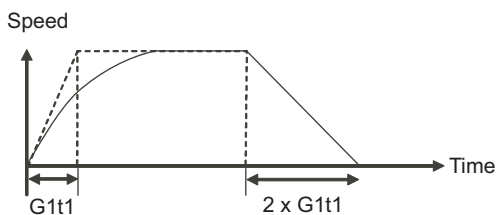

<Soft acceleration/deceleration>

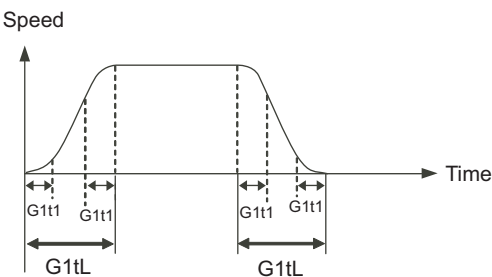

**---Setting range---**

1 to 5000 (ms)

#2009	G1t2	
Not used. Set to "0".		
#2010	fwd_g	Feed forward gain
Set a feed forward gain for pre-interpolation acceleration/deceleration. The larger the set value, the smaller the theoretical control error will be. However, if a machine vibration occurs, set the smaller value.		
---Setting range---		
0 to 200 (%)		
#2011	G0back	G0 backlash
Set up the backlash compensation amount when the direction is reversed with the movement command in rapid traverse feed mode or in manual mode (except for handle feed mode) .		
---Setting range---		
-9999999 to 9999999		
#2012	G1back	G1 backlash
Set up the backlash compensation amount when the direction is reversed with the movement command in cutting mode. G1 backlash is enabled in handle feed mode.		
---Setting range---		
-9999999 to 9999999		
#2013	OT -	Soft limit I -

Set a soft limit area with reference to the zero point of the basic machine coordinate. Set the coordinate in the negative direction for the movable area of stored stroke limit 1. The coordinate in the positive direction is set in "#2014 OT+".

To narrow the available range in actual use, use the parameters "#8204 OT-" and "#8205 OT+".

When the same value (other than "0") is set in this parameter and "#2014 OT+", this function will be disabled.

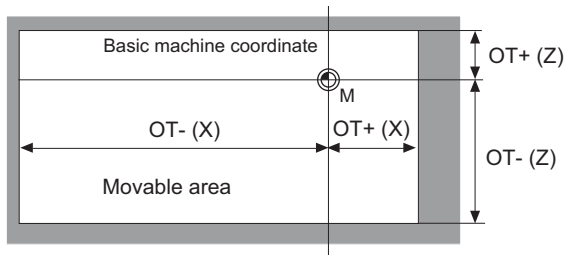

---Setting range---

-99999.999 to 99999.999 (mm)



<b>#2014</b>	<b>OT +</b>	<b>Soft limit I +</b>
--------------	-------------	-----------------------

Set a soft limit area with reference to the zero point of the basic machine coordinate. Set the coordinate in the positive direction for the movable area of stored stroke limit 1. The coordinate in the negative direction is set in "#2013 OT-".

To narrow the available range in actual use, use the parameters "#8204 OT-" and "#8205 OT+".

When the same value (other than "0") is set in this parameter and "#2013 OT-", this function will be disabled.

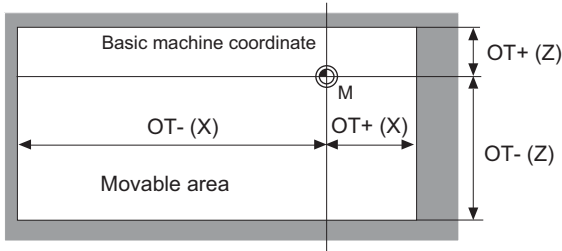

**---Setting range---**

-99999.999 to 99999.999 (mm)

<b>#2015</b>	<b>tlim-</b>	<b>Negative direction sensor of tool setter</b>
--------------	--------------	---

Set a sensor position in the negative direction when using the tool setter.

When the TLM is used, set up the distance of a tool replacement point (reference point) for measuring the tool length from the zero point to the measurement reference point (surface).

(Note) In the case of the basic axis and inclined axis of the inclined axis specifications, set the position on the orthogonal coordinate.

**---Setting range---**

-99999.999 to 99999.999 (mm)

<b>#2016</b>	<b>tlim+</b>	<b>Positive direction sensor of tool setter or TLM standard length</b>
--------------	--------------	--

Set the sensor position in the positive direction when using the tool setter.

When the TLM is used, set the distance from a tool change point (reference position) to the measurement basic point (surface) in order to measure the tool length.

(Note) In the case of the basic axis and inclined axis of the inclined axis specifications, set the position on the orthogonal coordinate.

**---Setting range---**

-99999.999 to 99999.999 (mm)

<b>#2017</b>	<b>tap_g</b>	<b>Axis servo gain</b>
--------------	--------------	------------------------

Set the position loop gain for special operations (synchronized tapping, interpolation with spindle C axis, etc.).

Set the value in 0.25 increments.

The standard setting value is "10".

**---Setting range---**

0.25 to 200.00 (rad/s)

<b>(PR) #2018</b>	<b>no_srv</b>	<b>Operation with no servo control</b>
-------------------	---------------	--

Select when performing test operation without connecting the drive unit and motor.

0: Normal operation

1: Test operation

When "1" is set, the operation will be possible even if drive units and motor are not connected, because the drive system alarm will be ignored.

This parameter is used for test operation during start up: Do not use during normal operation. If "1" is set during normal operation, errors will not be detected even if they occur.

<b>#2019</b>	<b>revnum</b>	<b>Return steps</b>
--------------	---------------	---------------------

Set the steps required for reference position return for each axis.

0: Not execute reference position return.

1 to max. number of NC axes: Steps required for reference position return

<b>#2020</b>	<b>o_chkp</b>	<b>Spindle orientation completion check during second reference position return</b>
<p>Set the distance from the second reference position to the position for checking that the spindle orientation has completed during second reference position return.</p> <p>When the set value is "0", the above check will be omitted.</p> <p><b>---Setting range---</b></p> <p>0 to 99999.999 (mm)</p>		
<b>#2021</b>	<b>out_f</b>	<b>Maximum speed outside soft limit range (For L system only)</b>
<p>Set the maximum speed outside the soft limit range.</p> <p><b>---Setting range---</b></p> <p>0 to 1000000 (mm/min)</p>		
<b>#2022</b>	<b>G30SLX</b>	<b>Validate soft limit (automatic and manual)</b>
<p>Select whether to disable a soft limit check during the second to the fourth reference position return in both automatic and manual operation modes.</p> <p>0: Enable 1: Disable</p>		
<b>#2023</b>	<b>ozfmin</b>	<b>Set up ATC speed lower limit</b>
<p>Set the minimum speed outside the soft limit range during the second to the fourth reference position return.</p> <p><b>---Setting range---</b></p> <p>0 to 1000000 (mm/min)</p>		
<b>#2024</b>	<b>synerr</b>	<b>Allowable error</b>
<p>Set the maximum synchronization error, allowable at the synchronization error check, for the master axis.</p> <p>When "0" is set, the error check will not be carried out.</p> <p><b>---Setting range---</b></p> <p>0 to 99999.999 (mm) During simple C-axis synchronous control: 0 to 99999.999(°)</p>		
<b>#2061</b>	<b>OT_1B-</b>	<b>Soft limit IB-</b>
<p>Set the coordinate of the lower limit of the area where the stored stroke limit IB is inhibited.</p> <p>Set a value from zero point in the basic machine coordinate system.</p> <p>If the same value (non-zero) with the same sign as that of "#2062 OT_1B+" is set, the stored stroke limit IB function will be disabled.</p> <p><b>---Setting range---</b></p> <p>-99999.999 to 99999.999 (mm)</p>		
<b>#2062</b>	<b>OT_1B+</b>	<b>Soft limit IB+</b>
<p>Set the coordinate of the upper limit of the area where the stored stroke limit IB is inhibited.</p> <p>Set a value from zero point in the basic machine coordinate system.</p> <p><b>---Setting range---</b></p> <p>-99999.999 to 99999.999 (mm)</p>		
<b>#2063</b>	<b>OT_1B type</b>	<b>Soft limit IB type</b>
<p>Select the type that applies the settings of "#2062 OT_1B+" and "#2061 OT_1B-" in stored stroke limit I.</p> <p>0: Soft limit IB 1: Disable 2: Soft limit IC 3: Soft limit is checked for the inclined axis control axis with the program coordinate system.</p> <p>(Note) This is valid only for inclined axis' basic axis and inclined axis.</p>		

	<b>#2068</b>	<b>G0fwdg</b>	<b>G00 feed forward gain</b>
			Set a feed forward gain for G00 pre-interpolation acceleration/deceleration. The larger the setting value, the shorter the positioning time during in-position checking. If a machine vibration occurs, set the smaller value.
			<b>---Setting range---</b> 0 to 200 (%)
	<b>#2069</b>	<b>Rcoeff</b>	<b>Axis arc radius error correction coefficient</b>
			Set the percentage to increase or decrease the arc radius error correction amount for each axis.
			<b>---Setting range---</b> -100.0 to +100.0 (%)
<b>(PR)</b>	<b>#2070</b>	<b>div_RT</b>	<b>Rotational axis division count</b>
			Set the number of divisions of one turn of the rotary axis under control. (Example) When "36" is set, one turn is supposed to be 36.000. (Note 1) When "0" is set, the normal rotary axis (360.000 degrees for one turn) is assumed. (Note 2) If this parameter is changed when the absolute position detection specification is used, absolute position data will be lost. Initialization must be performed again.
			<b>---Setting range---</b> 0 to 999
<b>(PR)</b>	<b>#2071</b>	<b>s_axis</b>	<b>Inclined axis selection (for L system only)</b>
			Select whether the axis is to be under the inclined-axis control or to be the basic axis corresponding to the inclined axis. 0: Not to be under the inclined-axis control 1: Inclined axis 2: Basic axis corresponding to inclined axis (Note) Each of "1" and "2" values must be set for only one axis. If either value is set for two or more axes, inclined-axis control does not work.
	<b>#2072</b>	<b>rslimt</b>	<b>Restart limit</b>
			Set the most minus (-) side position where restart search is possible. If the machine is positioned on the more minus (-) side than the set value in T-command restart mode, restart search in type 3 will be disabled.
			<b>---Setting range---</b> -99999.999 to 99999.999 (mm)
	<b>#2073</b>	<b>zrn_dog</b>	<b>Origin dog Random assignment device</b>
			Under the standard specifications, the "Reference position return near-point detection" signal is assigned to a fixed device. Set the device in this parameter to assign this signal to a position other than the fixed device. (Note1) This parameter is enabled in the following conditions. NC axis: When "#1226 aux10/bit5" is set to "1". PLC axis: When "#1246 set18/bit7" is set to "1". (Note 2) When this parameter is valid, do not set the existing device number. If the existing device number is set, an emergency stop will occur. However, no device number check will be performed for an axis to which the "Near-point dog ignored" signal or the "PLC axis near-point dog ignored" signal is input. (Note 3) Assign the "Reference position return near-point detection" signal to the I/O unit on the same base of the CNC CPU. Do not use the signal assigned to the network module such as CC-Link or Ethernet.
			<b>---Setting range---</b> 0000 to 02FF (HEX)

<b>#2074</b>	<b>H/W_OT+</b>	<b>H/W OT+ Random assignment device</b>
		<p>Under the standard specifications, the "Stroke end (+)" signal is assigned to a fixed device. Set the device in this parameter to assign this signal to a position other than the fixed device.</p> <p>(Note1) This parameter is enabled in the following conditions.</p> <p>NC axis: When "#1226 aux10/bit5" is set to "1".</p> <p>PLC axis: When "#1246 set18/bit7" is set to "1".</p> <p>(Note 2) When this parameter is valid, do not set the existing device number. If the existing device number is set, an emergency stop will occur. However, no device number check will be performed for an axis to which the "OT ignored" signal or the "PLC axis OT ignored" signal is input.</p> <p>(Note 3) Assign the "Stroke end" signal to the I/O unit on the same base of the CNC CPU. Do not use the signal assigned to the network module such as CC-Link or Ethernet.</p> <p><b>---Setting range---</b></p> <p>0000 to 02FF (HEX)</p>
<b>#2075</b>	<b>H/W_OT-</b>	<b>H/W OT- Random assignment device</b>
		<p>Under the standard specifications, the "Stroke end (-)" signal is assigned to a fixed device. Set the device in this parameter to assign this signal to a position other than the fixed device.</p> <p>(Note1) This parameter is enabled in the following conditions.</p> <p>NC axis: When "#1226 aux10/bit5" is set to "1".</p> <p>PLC axis: When "#1246 set18/bit7" is set to "1".</p> <p>(Note 2) When this parameter is valid, do not set the existing device number. If the existing device number is set, an emergency stop will occur. However, no device number check will be performed for an axis to which the "OT ignored" signal or the "PLC axis OT ignored" signal is input.</p> <p>(Note 3) Assign the "Stroke end" signal to the I/O unit on the same base of the CNC CPU. Do not use the signal assigned to the network module such as CC-Link or Ethernet.</p> <p><b>---Setting range---</b></p> <p>0000 to 02FF (HEX)</p>
<b>#2076</b>	<b>index_x</b>	<b>Index table indexing axis</b>
		<p>Select whether the axis is a normal axis or an index table indexing axis.</p> <p>0: Normal axis</p> <p>1: Index table indexing axis</p> <p>(Note) This parameter is valid only for the NC axis. The parameter is invalid if set for the PLC axis.</p>
<b>#2077</b>	<b>G0inps</b>	<b>G0 in-position width</b>
		<p>Set the in-position width for G0.</p> <p>Between SV024 and this parameter, the parameter with a larger value will be applied.</p> <p>When "0" is set, this parameter will be invalid. Only SV024 will be available.</p> <p>When "#1205 G0dbcc" is "1", SV024 is used as the G0 in-position width.</p> <p><b>---Setting range---</b></p> <p>0.000 to 99.999 (mm)</p>
<b>#2078</b>	<b>G1inps</b>	<b>G1 in-position width</b>
		<p>Set the in-position width for G1.</p> <p>Between SV024 and this parameter, the parameter with a larger value will be applied.</p> <p>When "0" is set, this parameter will be invalid. Only SV024 will be available.</p> <p><b>---Setting range---</b></p> <p>0.000 to 99.999 (mm)</p>
<b>(PR) #2079</b>	<b>chcomp</b>	<b>Chopping compensation coefficient</b>
		<p>Set the coefficient to be applied to the compensation amount for the insufficient amount caused by servo delay during chopping.</p> <p><b>---Setting range---</b></p> <p>0 to 10 (standard value: 8)</p>

<b>#2080</b>	<b>chwid</b>	<b>Bottom dead center position width</b>
<p>Set the tolerance between the commanded stroke and actual stroke.</p> <p>Compensation will be applied during chopping so that the result of [command width - maximum stroke of top or bottom dead point/ 2] will be within this tolerance.</p> <p><b>---Setting range---</b></p> <p>0 to 10.000 (mm)</p>		
<b>#2081</b>	<b>chclsp</b>	<b>Maximum chopping speed</b>
<p>Set the clamp speed in chopping operation.</p> <p>When "0" is set, the clamp speed will be determined by "#2002 clamp".</p> <p><b>---Setting range---</b></p> <p>0 to 60000 (mm/min)</p>		
<b>#2082</b>	<b>a_rstax</b>	<b>Restart position return order</b>
<p>Set the No. for each axis in order from the 1st automatically returning axis to the restart position.</p> <p>When "0" is set, the axis will not return.</p> <p>Note that when "0" is set for all axes, all of the axes will return simultaneously.</p> <p>(Note) On the absolute position system, when performing the restart search just after power ON, and when the axis that is the order 0 is moved by the follow-up, an operation error(M01 0128) may occur.</p> <p><b>---Setting range---</b></p> <p>0 to 16</p>		
<b>#2084</b>	<b>G60_ax</b>	<b>Unidirectional positioning operation selection</b>
<p>Select how to operate the unidirectional positioning when the positioning command (G00) is issued.</p> <p>0: Carry out unidirectional positioning according to the command and modal.</p> <p>1: Carry out unidirectional positioning regardless of the command and modal.</p> <p>Set "1" for the axis to carry out the unidirectional positioning at every positioning command, regardless of whether the unidirectional positioning command and modal are issued.</p> <p>&lt;Related parameters&gt;</p> <p>"#8209 G60 SHIFT" and "#2076 index_x"</p>		
<b>#2086</b>	<b>exdcax</b>	<b>External deceleration speed</b>
<p>Set the maximum feed rate for each axis when the external deceleration signal is ON.</p> <p>This parameter is valid when "#1239 set11/bit6" is set to "1".</p> <p><b>---Setting range---</b></p> <p>0 to 1000000 (mm/min)</p>		
<b>#2087</b>	<b>syncnt</b>	<b>Synchronization/superimposition control setting for each axis</b>
<p>Set the polarity of synchronized axis with respect to reference axis to the bit corresponding to each axis.</p> <p>0: Relative to reference axis, polarity is positive</p> <p>1: Relative to reference axis, polarity is negative</p> <p><b>---Setting range---</b></p> <p>0 to FF (hexadecimal)</p>		
<b>#2088</b>	<b>bsax_sy</b>	<b>Reference axis for synchronous control</b>
<p>Set the reference axis for synchronous control with the 2nd axis name (axname2). A numerical character cannot be set as the 1st character.</p> <p><b>---Setting range---</b></p> <p>1st character: A to Z</p> <p>2nd character: A to Z, 1 to 9</p>		
<b>#2089</b>	<b>bsax_pl</b>	<b>Superimposition control reference axis</b>
<p>Not used. Set to "0".</p>		
<b>#2090</b>	<b>plrapid</b>	<b>Rapid traverse rate for superimposition control</b>
<p>Not used. Set to "0".</p>		

<b>#2091</b>	<b>plclamp</b>	<b>Cutting feed clamp speed for superimposition control</b>
Not used. Set to "0".		
<b>#2092</b>	<b>plG0tL</b>	<b>G0 time constant for superimposition control (linear)</b>
Not used. Set to "0".		
<b>#2093</b>	<b>plG0t1</b>	<b>G0 time constant for superimposition control (primary delay)</b>
Not used. Set to "0".		
<b>#2094</b>	<b>plG1tL</b>	<b>G1 time constant for superimposition control (linear)</b>
Not used. Set to "0".		
<b>#2095</b>	<b>plG1t1</b>	<b>G1 time constant for superimposition control (primary delay)</b>
Not used. Set to "0".		
<b>#2096</b>	<b>crncsp</b>	<b>Minimum corner deceleration speed</b>
Set the minimum clamp speed for corner deceleration in the high-accuracy control mode. Normally set "0".		
(Note) This parameter is invalid during SSS control.		
<b>---Setting range---</b>		
0 to 1000000 (mm/min)		
<b>#2097</b>	<b>tlml2-</b>	<b>Sub side tool setter - direction sensor</b>
Set the sensor position (on sub side) in the (-) direction when using the tool setter on the sub spindle side.		
(Note) In the case of the basic axis and inclined axis of the inclined axis specifications, set the position on the orthogonal coordinate.		
<b>---Setting range---</b>		
-99999.999 to 99999.999 (mm)		
<b>#2098</b>	<b>tlml2+</b>	<b>Sub side tool setter + direction sensor</b>
Set the sensor position (on sub side) in (+) direction when using the tool setter on the sub spindle side.		
(Note) In the case of the basic axis and inclined axis of the inclined axis specifications, set the position on the orthogonal coordinate.		
<b>---Setting range---</b>		
-99999.999 to 99999.999 (mm)		
<b>#2102</b>	<b>skip_tL</b>	<b>Skip time constant linear</b>
Set a linear control time constant for variable speed skip acceleration and deceleration, or for an occasion where a skip command issues acceleration/deceleration time constant enabled (R1).		
The time constant will be enabled when LC (cutting feed with linear acceleration/deceleration) or F (soft acceleration/deceleration) is selected in "#2003 smgst" (Acceleration or deceleration modes).		
When set to "0", the time constant set by "#2007 G1tL" is used.		
<b>---Setting range---</b>		
0 to 4000 (ms)		
<b>#2103</b>	<b>skip_t1</b>	<b>Skip time constant primary delay / Second-step time constant for soft acceleration/deceleration</b>
Set a primary-delay time constant for variable speed skip acceleration and deceleration, or for an occasion where a skip command issues acceleration/deceleration time constant enabled (R1).		
The time constant will be enabled when C1 (cutting feed with the primary delay) or C3 (cutting feed with exponential acceleration and linear deceleration) is selected in "#2003 smgst" (Acceleration/deceleration modes). When the soft acceleration/deceleration is selected, the second-step time constant will be used.		
When set to "0", the time constant set by "#2008 G1t1" is used.		
<b>---Setting range---</b>		
0 to 5000 (ms)		

#2106	Index unit	Indexing unit
	Set the indexing unit to which the rotary axis can be positioned.	
	---Setting range---	
	0 to 360 (°)	
#2109	Rapid (H-precision)	Rapid traverse rate for high-accuracy control mode
	Set the rapid traverse rate for each axis in the high-accuracy control mode. When 0 is set, "#2001 rapid" is used.	
	---Setting range---	
	0 to 1000000 (mm/min)	
#2110	Clamp (H-precision)	Cutting feed clamp speed for high-accuracy control mode
	Set the cutting feed maximum speed for each axis in the high-accuracy control mode. When 0 is set, "#2002 clamp" is used.	
	---Setting range---	
	0 to 1000000 (mm/min)	
#2111	Bif valid	Quadrant protrusion compensation valid
	Set whether to enable the quadrant protrusion compensation.	
	0: Disable	
	1: Enable	
	If either of "#2112 Bif motor inertia", "#2115 Bif motor stl trq" or "#2113 Bif visc friction" is set to "0", quadrant protrusion compensation will not work even if this parameter is set to "1".	
#2112	Bif motor inertia	Motor inertia
	Set the motor inertia for quadrant protrusion compensation.	
	Refer to the servo manual and input the value appropriate for the motor.	
	---Setting range---	
	1 to 32000 ( $10^{-6}$ kgm <sup>2</sup> )	
#2113	Bif visc friction	Viscous friction
	Set the viscous friction for quadrant protrusion compensation.	
	After setting the other parameters to the appropriate values, monitor the machine end and gradually adjust the value.	
	If this parameter setting is small, a recess will form on the inner side of the circle, and if large, a protrusion will form on the outer side of the circle. When the value is appropriate, a spike-shaped quadrant protrusion will form based on normal step-shaped backlash.	
	---Setting range---	
	1 to 32767 (1/16 Nm/(rad/s))	
#2114	Bif fwdg	Compensation FF gain
	Set the feed forward gain for quadrant protrusion compensation.	
	After setting the other parameters to the appropriate values, monitor the machine end and gradually adjust the value.	
	If this parameter setting is small, a large quadrant protrusion will form, and if large, a recess will form on the inner side of the circle.	
	---Setting range---	
	0 to 1000 (%)	
#2115	Bif motor stl trq	Motor stall torque
	Set the motor rated current for quadrant protrusion compensation.	
	Refer to the servo manual and input the value appropriate for the motor.	
	---Setting range---	
	1 to 16000 (1/256 Nm)	

<b>(PR)</b>	<b>#2116</b>	<b>v_axis</b>	<b>Hypothetical axis</b>
			Select whether to control the axis as a hypothetical axis or as an actual axis in hypothetical linear axis control. When not using the hypothetical linear axis control, set "0" for all axes. 0: Actual axis 1: Hypothetical axis
<b>(PR)</b>	<b>#2117</b>	<b>v_axno</b>	<b>Hypothetical axis No.</b>
			In hypothetical linear axis control, specify the relation of the actual axis to the hypothetical axis that lies in the hypothetical plane. For an actual linear axis, specify the axis number of the hypothetical axis that is parallel to the axis. For an actual rotary axis, specify the axis number of the hypothetical axis that is perpendicular to the actual linear axis. When a PLC axis number is set, the setting will be ignored. For a system configured with multiple part systems, an axis number from different part system cannot be set. 0: Actual or hypothetical axis out of the hypothetical plane 1 or later (axis numbers used in the part system): Hypothetical axis number to be defined <b>---Setting range---</b> 0 to 8
<b>(PR)</b>	<b>#2118</b>	<b>SscDrSel</b>	<b>Speed monitor Door selection</b>
			Select which door group of the speed monitoring the spindle belongs to. 0000: Door 1 group. 0001: Door 1 group. 0002: Door 2 group. 0003: Door 1 and 2 group. The speed monitoring will not be executed when "#2313 SV113 SSF8/bitF" is OFF regardless of this parameter. The selected door group must be set when setting the synchronous control. The spindle/C axis control enables the door selection in "#3071 SscDrSelSp" for the corresponding spindle.
	<b>#2121</b>	<b>vbacklash valid</b>	<b>Variable backlash valid/continuous or Variable backlash II valid</b>
			Select whether the variable backlash is to be disabled/enabled/continuous, or variable backlash II enabled. 0: Disabled 1: Enable 2: Continuous 3: Enable variable backlash II ("#2011 G0back" and "#2012 G1back" will not work unless "0: Disable" is selected.)
	<b>#2122</b>	<b>G0vback+</b>	<b>Variable G0 backlash +</b>
			Set the compensation amount for the range of each position during rapid traverse. (+: B1, =: B2, -: B3 on the compensation amount table) <b>---Setting range---</b> -99999999 to 99999999 (Interpolation unit)
	<b>#2123</b>	<b>G0vback=</b>	<b>Variable G0 backlash =</b>
			Set the compensation amount for the range of each position during rapid traverse. (+: B1, =: B2, -: B3 on the compensation amount table) <b>---Setting range---</b> -99999999 to 99999999 (Interpolation unit)
	<b>#2124</b>	<b>G0vback-</b>	<b>Variable G0 backlash -</b>
			Set the compensation amount for the range of each position during rapid traverse. (+: B1, =: B2, -: B3 on the compensation amount table) <b>---Setting range---</b> -99999999 to 99999999 (Interpolation unit)



<b>#2125</b>	<b>G1vback+</b>	<b>Variable G1 backlash +</b>
Set the compensation amount for the range of each position during cutting feed. (+: A1, =: A2, -: A3 on the compensation amount table)		
<b>---Setting range---</b>		
-99999999 to 99999999 (Interpolation unit)		
<b>#2126</b>	<b>G1vback=</b>	<b>Variable G1 backlash =</b>
Set the compensation amount for the range of each position during cutting feed. (+: A1, =: A2, -: A3 on the compensation amount table)		
<b>---Setting range---</b>		
-99999999 to 99999999 (Interpolation unit)		
<b>#2127</b>	<b>G1vback-</b>	<b>Variable G1 backlash -</b>
Set the compensation amount for the range of each position during cutting feed. (+: A1, =: A2, -: A3 on the compensation amount table)		
<b>---Setting range---</b>		
-99999999 to 99999999 (Interpolation unit)		
<b>#2128</b>	<b>G1vback feed1</b>	<b>G1 variable backlash compensation amount change-over speed 1</b>
Set the speed range during cutting feed. (The speed less than 1 is the low speed, and the speed exceeding 2 is the high speed.) Note that the speed range is identified in the order of low, high and medium speed. Consider whether the set value should be larger or smaller than other values.		
<b>---Setting range---</b>		
0 to 480000 (mm/min)		
<b>#2129</b>	<b>G1vback feed2</b>	<b>G1 variable backlash compensation amount change-over speed 2</b>
Set the speed range during cutting feed. (The speed less than 1 is the low speed, and the speed exceeding 2 is the high speed.) Note that the speed range is identified in the order of low, high and medium speed. Consider whether the set value should be larger or smaller than other values.		
<b>---Setting range---</b>		
0 to 480000 (mm/min)		
<b>#2130</b>	<b>G1vback dist1</b>	<b>G1 variable backlash compensation amount change-over distance 1</b>
Set the range of the distance during cutting feed. (The distance less than 1 is the small distance, and the distance exceeding 2 is the large distance.) Note that the distance range is identified in the order of small, large and medium. Consider whether the set value should be larger or smaller than other values.		
<b>---Setting range---</b>		
0 to 999999.999999 (mm)		
<b>#2131</b>	<b>G1vback dist2</b>	<b>G1 variable backlash compensation amount change-over distance 2</b>
Set the range of the distance during cutting feed. (The distance less than 1 is the small distance, and the distance exceeding 2 is the large distance.) Note that the distance range is identified in the order of small, large and medium. Consider whether the set value should be larger or smaller than other values.		
<b>---Setting range---</b>		
0 to 999999.999999 (mm)		

<b>#2132</b>	<b>vback pos1</b>	<b>Variable backlash compensation amount changeover end point position 1</b>
<p>Set the range of the center of the end point position.            (The range less than position 1 is the - range, and the range exceeding position 2 is the + range.)            The end point position range is determined in the order of -, + , and center. Consider whether the set value should be larger or smaller than other values.            (Note 1) If continuous variable backlash is set with "#2121 vbacklash valid", position 1 will be set as the position - point and position 2 will be set as the position + point.            (Note 2) When the size relation of the compensation amount changeover speed and distance 1 and 2 is not appropriate while the variable backlash compensation is valid, the followings will be applied: If the backlash speed and distance are smaller than the compensation amount changeover speed and distance 1, both the speed and distance will be small; if larger than the compensation amount changeover speed and distance 2, both the speed and distance will be large.</p> <p><b>---Setting range---</b>            -999999.999999 to 999999.999999 (mm)</p>		
<b>#2133</b>	<b>vback pos2</b>	<b>Variable backlash compensation amount changeover end point position 2</b>
<p>Set the range of the center of the end point position.            (The range less than position 1 is the - range, and the range exceeding position 2 is the + range.)            The end point position range is determined in the order of -, + , and center. Consider whether the set value should be larger or smaller than other values.            (Note 1) If continuous variable backlash is set with "#2121 vbacklash valid", position 1 will be set as the position - point and position 2 will be set as the position + point.            (Note 2) When the size relation of the compensation amount changeover speed and distance 1 and 2 is not appropriate while the variable backlash compensation is valid, the followings will be applied: If the backlash speed and distance are smaller than the compensation amount changeover speed and distance 1, both the speed and distance will be small; if larger than the compensation amount changeover speed and distance 2, both the speed and distance will be large.</p> <p><b>---Setting range---</b>            -999999.999999 to 999999.999999 (mm)</p>		
<b>#2134</b>	<b>vback arc K</b>	<b>Variable backlash arc compensation coefficient</b>
<p>Set the arc compensation coefficient.</p> <p><b>---Setting range---</b>            0 to 300(%)</p>		
<b>#2135</b>	<b>vback feed refpt</b>	<b>Variable backlash reference position selection (speed)</b>
<p>Select the speed range to be used as the reference position.            0: Low speed            1: Medium speed            2: High speed</p>		
<b>#2136</b>	<b>vback pos refpt</b>	<b>Variable backlash reference position selection (end point position)</b>
<p>Select the end point range to be used as the reference position.            0: Position + range            1: Position center range            2: Position - range</p>		
<b>#2137</b>	<b>vback dir refpt</b>	<b>Variable backlash reference position selection (entry direction)</b>
<p>Select the entry direction to be used as the reference position.            0: Entry direction +            1: Entry direction -</p>		

#2138	<b>vback pos center</b>	<b>Continuous variable backlash position center point</b>	
<p>Set the position center point. (This is used only when continuous variable backlash is set with "#2121 vbacklash valid".) Set a value between "#2132 vback pos1" and "#2133 vbackpos2" for the position center point.</p> <p>(Note) When the size relation of the compensation amount changeover speed and distance 1 and 2 is not appropriate while the variable backlash compensation is valid, the followings will be applied: If the backlash speed and distance are smaller than the compensation amount changeover speed and distance 1, both the speed and distance will be small; if larger than the compensation amount changeover speed and distance 2, both the speed and distance will be large.</p>			
<p>---Setting range---</p> <p>-999999.999999 to 999999.999999 (mm)</p>			
#2139	<b>omrff_off</b>	<b>OMR-FF invalid</b>	
<p>Select whether to enable or temporarily disable the OMR-FF control when OMR-FF is valid.</p> <p>0: Enable 1: Temporarily disable</p> <p>When "1" is selected while OMR-FF is valid, OMR-FF can be temporarily disabled and conventional feed forward control can be applied instead.</p>			
(PR)	#2140	<b>Ssc Svof Filter</b>	<b>Speed monitor Error detection time during servo OFF</b>
<p>Set the error detection time for when an error of command speed monitoring or feedback speed monitoring is detected during servo OFF.</p> <p>An alarm will occur if the time, for which the speed has been exceeding the safe speed or safe rotation speed, exceeds the error detection time set in this parameter.</p> <p>If "0" is set, it will be handled as 200 (ms).</p>			
<p>---Setting range---</p> <p>0 to 9999(ms)</p>			
#2141	<b>chtL</b>	<b>Chopping first-step time constant for soft acceleration/ deceleration</b>	
<p>Set the first-step time constant for the chopping axis when soft acceleration/deceleration is applied.</p> <p>Note that, however, there may be cases where actual time constant is shorter than the set time constant, because the time constant is automatically calculated according to the feedrate so that the acceleration rate during acceleration/deceleration (clamp speed/chopping time constant) will be constant.</p> <p>When "0" is set, "#2007 G1tL" will be valid.</p>			
<p>---Setting range---</p> <p>0 to 4000 (ms)</p>			
#2142	<b>cht1</b>	<b>Chopping second-step time constant for soft acceleration/ deceleration</b>	
<p>Set the second-step time constant for the chopping axis when soft acceleration/deceleration is applied.</p> <p>Note that, however, there may be cases where actual time constant is shorter than the set time constant, because the time constant is automatically calculated so that the ratio between first-step and second-step time constant will be constant.</p> <p>When "0" is set, "#2008 G1t1" will be valid.</p>			
<p>---Setting range---</p> <p>0 to 4000 (ms)</p>			
#2143	<b>polar</b>	<b>Control axis relative polarity</b>	
<p>Not used. Set to "0".</p>			

#2144	baseps	Base machine coordinate zero point relative distance
-------	--------	--

Not used. Set to "0.000".

#2146	Bif_L1	Reference distance for position-dependent increasing-type backlash compensation 1
-------	--------	---

Set the distance for specifying the compensation change rate in position-dependent increasing-type backlash compensation.

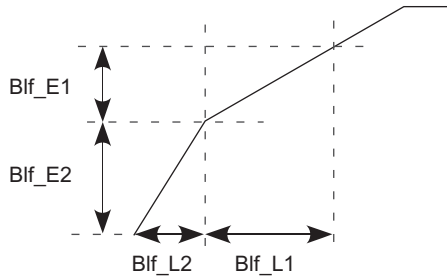

When "#2148 Bif\_E1" is set to "0", the position-dependent increasing-type backlash compensation function will be disabled.

**---Setting range---**

0.000 to 99999.999 (mm)

#2147	Bif_L2	Reference distance for position-dependent increasing-type backlash compensation 2
-------	--------	---

Set the distance for specifying the compensation change rate in position-dependent increasing-type backlash compensation.

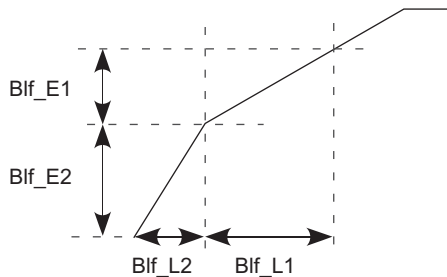

When "#2148 Bif\_E1" is set to "0", the position-dependent increasing-type backlash compensation function will be disabled.

**---Setting range---**

0.000 to 99999.999 (mm)

<b>#2148</b>	<b>Blf_E1</b>	<b>Reference amount of position-dependent increasing-type backlash compensation 1</b>
--------------	---------------	---

Set the compensation amount for specifying the compensation change rate in position-dependent increasing-type backlash compensation.

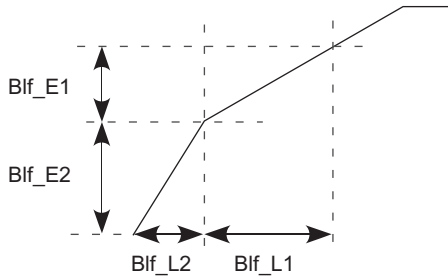

When "#2148 Blf\_E1" is set to "0", the position-dependent increasing-type backlash compensation function will be disabled.

**---Setting range---**

0 to 9999999 (Machine error compensation unit)

<b>#2149</b>	<b>Blf_E2</b>	<b>Reference amount of position-dependent increasing-type backlash compensation 2</b>
--------------	---------------	---

Set the compensation amount for specifying the compensation change rate in position-dependent increasing-type backlash compensation.

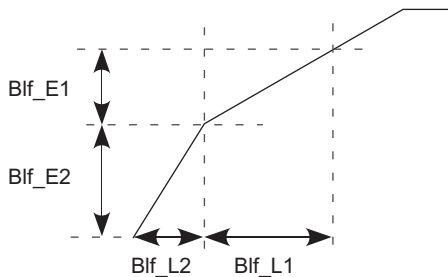

When "#2148 Blf\_E1" is set to "0", the position-dependent increasing-type backlash compensation function will be disabled.

**---Setting range---**

0 to 9999999 (Machine error compensation unit)

<b>#2150</b>	<b>Rot_len</b>	<b>Farthest distance from rotary axis center</b>
--------------	----------------	--

Set the farthest distance of the rotating part from the rotation center for executing the 3D machine interference check. When "0" is set, this distance will conform to the rotary axis' specification speed.

**---Setting range---**

0.000 to 99999.999 (mm)

<b>#2151</b>	<b>rated_spd</b>	<b>Rated speed</b>
--------------	------------------	--------------------

Set the maximum speed which can be driven with the motor's maximum torque.

(Note 1) This parameter's setting value must be smaller than "#2001 rapid Rapid traverse". If bigger, constant inclination acceleration/deceleration will be applied.

(Note 2) If rapid traverse constant-gradient multi-step acceleration/deceleration is valid, and also if this parameter is set to "0", constant inclination acceleration/deceleration will be applied.

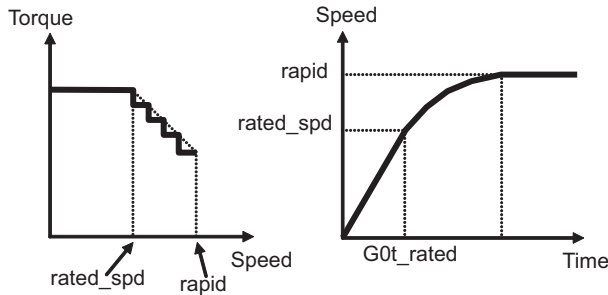

**---Setting range---**

0 to 1000000 (mm/min)

<b>#2152</b>	<b>acc_rate</b>	<b>Acceleration rate in proportion to the maximum acceleration rate</b>
--------------	-----------------	---

Set the rate in proportion to the maximum acceleration rate in rapid traverse.

(Note) If this parameter is set to "0" or "100", constant inclination acceleration/deceleration will be applied.

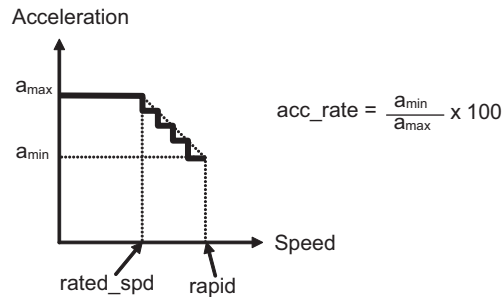

**---Setting range---**

0 to 100 (%)

<b>#2153</b>	<b>G0t_rated</b>	<b>G0 time constant up to rated speed (multi-step acceleration/deceleration)</b>
--------------	------------------	--

Set the acceleration rate up to the rated speed of rapid traverse constant-gradient multi-step acceleration/deceleration.

(Note) If this parameter is set to "0", constant inclination acceleration/deceleration will be applied.

**---Setting range---**

0 to 4000 (ms)

<b>#2155</b>	<b>hob_fwd_g</b>	<b>Feed forward gain for hobbing machining</b>
--------------	------------------	--

Set the feed forward gain when controlling as workpiece axis of tool spindle synchronization II (hobbing).

**---Setting range---**

0 to 200 (%)

<b>#2157</b>	<b>G1bFx</b>	<b>Maximum axis-specific pre-interpolation cutting feed rate</b>
--------------	--------------	--

Not used. Set to "0".

<b>#2158</b>	<b>G1btLx</b>	<b>Axis-specific pre-interpolation cutting feed time constant</b>
--------------	---------------	---

Not used. Set to "0".

<b>#2159</b>	<b>compx</b>	<b>Accuracy coefficient for each axis</b>
<p>Specify the compensation coefficient to be used for adjusting a path error and clamp speed at a corner for each axis during the high-accuracy control mode. If the setting value is larger, the edge accuracy will improve, but the cycle time may be longer because the corner speed will slow down.</p> <p>This parameter is disabled when the axis-specific acceleration tolerance control is OFF.</p> <p>---Setting range---</p> <p>-1000 to 99 (%)</p>		
<b>#2161</b>	<b>exdcax1</b>	<b>External deceleration speed 1</b>
<p>Set the upper limit value of feedrate for each axis when the external deceleration signal is enabled and external deceleration speed 1 is selected.</p> <p>This parameter is valid when "#1239 set11/bit6" is set to "1".</p> <p>---Setting range---</p> <p>0 to 1000000 (mm/min)</p>		
<b>#2162</b>	<b>exdcax2</b>	<b>External deceleration speed 2</b>
<p>Set the upper limit value of feedrate for each axis when the external deceleration signal is enabled and external deceleration speed 2 is selected.</p> <p>This parameter is valid when "#1239 set11/bit6" is set to "1".</p> <p>---Setting range---</p> <p>0 to 1000000 (mm/min)</p>		
<b>#2163</b>	<b>exdcax3</b>	<b>External deceleration speed 3</b>
<p>Set the upper limit value of feedrate for each axis when the external deceleration signal is enabled and external deceleration speed 3 is selected.</p> <p>This parameter is valid when "#1239 set11/bit6" is set to "1".</p> <p>---Setting range---</p> <p>0 to 1000000 (mm/min)</p>		
<b>#2164</b>	<b>exdcax4</b>	<b>External deceleration speed 4</b>
<p>Set the upper limit value of feedrate for each axis when the external deceleration signal is enabled and external deceleration speed 4 is selected.</p> <p>This parameter is valid when "#1239 set11/bit6" is set to "1".</p> <p>---Setting range---</p> <p>0 to 1000000 (mm/min)</p>		
<b>#2165</b>	<b>exdcax5</b>	<b>External deceleration speed 5</b>
<p>Set the upper limit value of feedrate for each axis when the external deceleration signal is enabled and external deceleration speed 5 is selected.</p> <p>This parameter is valid when "#1239 set11/bit6" is set to "1".</p> <p>---Setting range---</p> <p>0 to 1000000 (mm/min)</p>		
<b>#2169</b>	<b>Man meas rtn dir</b>	<b>Return direction in manual measurement</b>
<p>Select the direction of return operation in manual measurement.</p> <p>0: Opposite to the contact direction</p> <p>1: Fixed to the + direction</p> <p>Attempting return in the - direction will cause the operation alarm "0033 Rtn dir err in manual measure".</p> <p>2: Fixed to the - direction</p> <p>Attempting return in the + direction will cause the operation alarm "0033 Rtn dir err in manual measure".</p>		
<b>#2170</b>	<b>Lmc1QR</b>	<b>Lost motion compensation gain 1 for high-speed retract</b>
<p>Set the lost motion compensation gain in drilling cycle at high-speed retract (CW: - to + direction, CCW: + to - direction).</p> <p>Set "-1" when drilling cycle at high-speed retract is not performed.</p> <p>When set to 0, the performance will follow the setting of "#2171 Lmc2QR (Lost motion compensation gain 2 for high-speed retract)".</p> <p>---Setting range---</p> <p>-1, 0 to 200(%)</p>		

<b>#2171</b>	<b>Lmc2QR</b>	<b>Lost motion compensation gain 2 for high-speed retract</b>
<p>Set the lost motion compensation gain in drilling cycle at high-speed retract (CW: - to + direction, CCW: + to - direction).</p> <p>Set "-1" when drilling cycle at high-speed retract is not performed.</p> <p>When set to 0, the performance will follow the setting of "#2170 Lmc1QR (Lost motion compensation gain 1 for high-speed retract)".</p> <p><b>---Setting range---</b></p> <p>-1, 0 to 200(%)</p>		
<b>#2172</b>	<b>LmcdQR</b>	<b>Lost motion compensation timing for high-speed retract</b>
<p>Set the timing of the lost motion compensation in drilling cycle at high-speed retract.</p> <p>When set to 0, the performance will follow the setting of "#2239 SV039 LMCD (Lost motion compensation timing)".</p> <p><b>---Setting range---</b></p> <p>0 to 2000 (ms)</p>		
<b>#2173</b>	<b>LmckQR</b>	<b>Lost motion compensation 3 spring constant for high-speed retract</b>
<p>Set the machine system's spring constant when using lost motion compensation type 3 in drilling cycle with high-speed retract.</p> <p>When set to "0", the performance will follow the setting of "#2285 SV085 LMCK (Lost motion compensation 3 spring constant)".</p> <p><b>---Setting range---</b></p> <p>0 to 32767 (0.01%/μm)</p>		
<b>#2174</b>	<b>LmccQR</b>	<b>Lost motion compensation 3 viscous coefficient for high-speed retract</b>
<p>Set the machine system's viscous coefficient when using lost motion compensation type 3 in drilling cycle at high-speed retract.</p> <p>When set to "0", the performance will follow the setting of "#2286 SV086 LMCc (Lost motion compensation 3 viscous coefficient)".</p> <p><b>---Setting range---</b></p> <p>0 to 32767(0.01%/μm)</p>		
<b>#2175</b>	<b>Special Ax Radius</b>	<b>Special diametral axis radius</b>
<p>Set the radius of the special diametral axis.</p> <p><b>---Setting range---</b></p> <p>0 to 99999.999 (mm)</p>		
<b>#2176</b>	<b>Special Ax Clamp</b>	<b>Special diametral axis clamp speed</b>
<p>Set a clamp speed for the special diametral axis control.</p> <p>Set the limit speed of the drive system in this parameter.</p> <p><b>---Setting range---</b></p> <p>0 to 1000000 (°/min)</p> <p>(Note) For "#2001 rapid" and "#2002 clamp", set speeds on a machining line. When the value in "#2176 Special Ax Clamp" is smaller than that in "#2001 rapid", "Special Ax Clamp" value will be applied to the clamp speed.</p>		
<b>#2177</b>	<b>ManualFeedBtL</b>	<b>Time constant for manual feed rate B</b>
<p>Set the acceleration/deceleration time constant for manual feed rate B.</p> <p>(Note) When set to "0", this parameter will not be used: conventional acceleration/deceleration will be performed.</p> <p><b>---Setting range---</b></p> <p>0 to 20000 (ms)</p>		



(PR)	#2180	S_DIN	Speed observation input door No.
			<p>Set the door signal input in the drive unit. Use this parameter only when the axis with a door signal belongs to several door groups. The correspondence between the door signals and bits are as follows.</p> <p>bit0: Door1 signal bit1: Door2 signal</p> <p>If the axis does not receive any door signal, set to "0". If 0 is set to the axis to which a door signal is input, the setting of #2118 is applied. Do not turn ON more than one bit. Only the door signals set in #2118 can be set.</p> <p>---Setting range---</p> <p>0000 to 0002 (HEX)</p>
(PR)	#2181	sscfeed1	Observation speed 1
			<p>Set the observation speed, which is at the machine end, in the multi-step speed monitor.</p> <p>(Note 1) When the setting value is larger than 18000, the last 2 digits will be ignored. E.g.: 1234567 -&gt; 1234500 (mm/min, °/min)</p> <p>(Note 2) Observation speeds (#2181 to #2186 and #2191 to #2192) need to satisfy the following condition. If not satisfied, the alarm (Y20 0007) will result.</p> $\frac{\text{sscfeed1} \sim 8}{\text{SV018:PIT}} \times \frac{\text{SV002:PC2}}{\text{SV001:PC1}} \leq 32767$ <p>---Setting range---</p> <p>0 to 6553500 (mm/min or °/min)</p>
(PR)	#2182	sscfeed2	Observation speed 2
			<p>Set the observation speed, which is at the machine end, in the multi-step speed monitor.</p> <p>(Note 1) When the setting value is larger than 18000, the last 2 digits will be ignored. E.g.: 1234567 -&gt; 1234500 (mm/min, °/min)</p> <p>(Note 2) Observation speeds (#2181 to #2186 and #2191 to #2192) need to satisfy the following condition. If not satisfied, the alarm (Y20 0007) will result.</p> $\frac{\text{sscfeed1} \sim 8}{\text{SV018:PIT}} \times \frac{\text{SV002:PC2}}{\text{SV001:PC1}} \leq 32767$ <p>---Setting range---</p> <p>0 to 6553500 (mm/min or °/min)</p>
(PR)	#2183	sscfeed3	Observation speed 3
			<p>Set the observation speed, which is at the machine end, in the multi-step speed monitor.</p> <p>(Note 1) When the setting value is larger than 18000, the last 2 digits will be ignored. E.g.: 1234567 -&gt; 1234500 (mm/min, °/min)</p> <p>(Note 2) Observation speeds (#2181 to #2186 and #2191 to #2192) need to satisfy the following condition. If not satisfied, the alarm (Y20 0007) will result.</p> $\frac{\text{sscfeed1} \sim 8}{\text{SV018:PIT}} \times \frac{\text{SV002:PC2}}{\text{SV001:PC1}} \leq 32767$ <p>---Setting range---</p> <p>0 to 6553500 (mm/min or °/min)</p>

(PR)	#2184	sscfeed4	Observation speed 4
			<p>Set the observation speed, which is at the machine end, in the multi-step speed monitor.</p> <p>(Note 1) When the setting value is larger than 18000, the last 2 digits will be ignored. E.g.: 1234567 -&gt; 1234500 (mm/min, °/min)</p> <p>(Note 2) Observation speeds (#2181 to #2186 and #2191 to #2192) need to satisfy the following condition. If not satisfied, the alarm (Y20 0007) will result.</p> $\frac{\text{sscfeed1} \sim 8}{\text{SV018:PIT}} \times \frac{\text{SV002:PC2}}{\text{SV001:PC1}} \leq 32767$ <p>---Setting range---</p> <p>0 to 6553500 (mm/min or °/min)</p>
(PR)	#2185	sscfeed5	Observation speed 5
			<p>Set the observation speed, which is at the machine end, in the multi-step speed monitor.</p> <p>(Note 1) When the setting value is larger than 18000, the last 2 digits will be ignored. E.g.: 1234567 -&gt; 1234500 (mm/min, °/min)</p> <p>(Note 2) Observation speeds (#2181 to #2186 and #2191 to #2192) need to satisfy the following condition. If not satisfied, the alarm (Y20 0007) will result.</p> $\frac{\text{sscfeed1} \sim 8}{\text{SV018:PIT}} \times \frac{\text{SV002:PC2}}{\text{SV001:PC1}} \leq 32767$ <p>---Setting range---</p> <p>0 to 6553500 (mm/min or °/min)</p>
(PR)	#2186	sscfeed6	Observation speed 6
			<p>Set the observation speed, which is at the machine end, in the multi-step speed monitor.</p> <p>(Note 1) When the setting value is larger than 18000, the last 2 digits will be ignored. E.g.: 1234567 -&gt; 1234500 (mm/min, °/min)</p> <p>(Note 2) Observation speeds (#2181 to #2186 and #2191 to #2192) need to satisfy the following condition. If not satisfied, the alarm (Y20 0007) will result.</p> $\frac{\text{sscfeed1} \sim 8}{\text{SV018:PIT}} \times \frac{\text{SV002:PC2}}{\text{SV001:PC1}} \leq 32767$ <p>---Setting range---</p> <p>0 to 6553500 (mm/min or °/min)</p>
(PR)	#2187	chgPLCax	PLC axis switchover axis No.
			<p>Specify the I/F No. of the PLC axis to use when switching between NC axis and PLC axis. Set the I/F No. of a vacant PLC axis.</p> <p>When not using, set to "0".</p> <p>---Setting range---</p> <p>0 to 8</p>

(PR)	#2188	S_Sign	Safety observation signal input
<p>This parameter specifies which observation speed change signal is input in the drive unit. The observation speed change signal corresponds to the following bits of the parameter.</p> <p>bit0: Observation speed change signal 1 is connected.</p> <p>bit1: Observation speed change signal 2 is connected.</p> <p>bit2: Observation speed change signal 3 is connected.</p> <p>If the axis receives no observation speed change signal, set to "0000".</p> <p>(Note) When a same setting value is set to more than one axis, or when more than one bit is set to turn ON for one axis, the alarm (Y20 0027) will occur.</p> <p>---Setting range---</p> <p>0000 to 0004 (HEX)</p>			
	#2189	StlTrq (PwrCal)	Stall torque for power computation
<p>Specify the stall torque of the servo motor.</p> <p>This value is used for calculating the servo motor's power consumption.</p> <p>---Setting range---</p> <p>0.000 to 1000.000 (N·m)</p>			
(PR)	#2190	OT_Rreg	Designate R register for stored stroke limit I
<p>Set the head R register No. to be used for setting/checking stored stroke limit I.</p> <p>Eight consecutive R registers from the R register No. set here will be the area for stored stroke limit I.</p> <p>Changing the areas for stored stroke limit I will be disabled if an R register that is not in the user area is set.</p> <p>In addition, make sure to set an even number for the head R register No. Changing the areas for stored stroke limit I will be disabled if an odd number is set.</p> <p>---Setting range---</p> <p>0 to 29892</p>			
(PR)	#2191	sscfeed7	Observation speed 7
<p>Set the observation speed, which is at the machine end, in the multi-step speed monitor.</p> <p>(Note 1) When the setting value is larger than 18000, the last 2 digits will be ignored. E.g.: 1234567 -&gt; 1234500 (mm/min, °/min)</p> <p>(Note 2) Observation speeds (#2181 to #2186 and #2191 to #2192) need to satisfy the following condition. If not satisfied, the alarm (Y20 0007) will result.</p> $\frac{\text{sscfeed1} \sim 8}{\text{SV018:PIT}} \times \frac{\text{SV002:PC2}}{\text{SV001:PC1}} \leq 32767$ <p>---Setting range---</p> <p>0 to 6553500 (mm/min or °/min)</p>			
(PR)	#2192	sscfeed8	Observation speed 8
<p>Set the observation speed, which is at the machine end, in the multi-step speed monitor.</p> <p>(Note 1) When the setting value is larger than 18000, the last 2 digits will be ignored. E.g.: 1234567 -&gt; 1234500 (mm/min, °/min)</p> <p>(Note 2) Observation speeds (#2181 to #2186 and #2191 to #2192) need to satisfy the following condition. If not satisfied, the alarm (Y20 0007) will result.</p> $\frac{\text{sscfeed1} \sim 8}{\text{SV018:PIT}} \times \frac{\text{SV002:PC2}}{\text{SV001:PC1}} \leq 32767$ <p>---Setting range---</p> <p>0 to 6553500 (mm/min or °/min)</p>			

#2195	hob_tL	Hobbing workpiece axis time constant
<p>Set the constant inclination acceleration/deceleration time constant of the hobbing workpiece axis when issuing a hobbing command while the hobbing spindle is rotating. Hobbing workpiece axis time constant is the constant inclination acceleration/deceleration time constant with respect to #2002 Cutting feed rate for clamp function.</p>		
<p>If the setting value of hobbing workpiece axis time constant is out of setting range, set the maximum value in the setting range.</p>		
<p>---Setting range---</p>		
<p>1 to 4000 (ms)</p>		
#2198	G0tMin	Minimum time constant for rapid traverse constant-gradient acc./dec.
<p>Acceleration/Deceleration is carried out so that the acceleration/deceleration time will not become longer than this parameter's setting when the acceleration/deceleration type of rapid traverse command is constant inclination.</p>		
<p>Set a value smaller than "#2004 G0tL".</p>		
<p>This parameter is enabled when "#1200 G0_acc" is constant inclination type.</p>		
<p>This parameter is enabled only during fixed cycle if "#1253 set25/bit2" (Acceleration/Deceleration mode change in hole drilling cycle) is enabled even if "#1200 G0_acc" is constant inclination type.</p>		
<p>This parameter is disabled if "0" or a value larger than "#2004 G0tL" is set.</p>		
<p>---Setting range---</p>		
<p>0 to 4000 (ms)</p>		
#2199	G1tMin	Minimum time constant for cutting feed constant inclination acc./dec.
<p>Acceleration/Deceleration is carried out so that the acceleration/deceleration time will not become longer than this parameter's setting when the acceleration/deceleration type of linear interpolation command is constant inclination.</p>		
<p>Set a value smaller than "#2007 G1tL".</p>		
<p>This parameter is enabled when "#1201 G1_acc" is constant inclination type.</p>		
<p>This parameter is enabled only during fixed cycle if "#1253 set25/bit2" (Acceleration/Deceleration mode change in hole drilling cycle) is enabled even if "#1201 G1_acc" is constant inclination type.</p>		
<p>This parameter is disabled if "0" or a value larger than "#2007 G1tL" is set.</p>		
<p>---Setting range---</p>		
<p>0 to 4000 (ms)</p>		
#2561	VBL2 VG1	Variable backlash comp II Changeover speed 1
<p>Set the changeover speed at speed normalization.</p>		
<p>Set a value smaller than that in "#2562 VBL2 VG0".</p>		
<p>Normally, the "#2561 VBL2 VG1" value corresponds to the cutting feedrate, the "#2562 VBL2 VG0" value to the rapid traverse rate.</p>		
<p>---Setting range---</p>		
<p>1 to 1000000 (mm/min)</p>		

<b>#2562</b>	<b>VBL2 VG0</b>	<b>Variable backlash comp II Changeover speed 2</b>
<p>Set the changeover speed at speed normalization.  Set a value greater than that in "#2561 VBL2 VG1".  Normally, the "#2561 VBL2 VG1" value corresponds to the cutting feedrate, the "#2562 VBL2 VG0" value to the rapid traverse rate.</p> <p><b>---Setting range---</b>  1 to 1000000 (mm/min)</p>		
<b>#2563</b>	<b>VBL2 P1</b>	<b>Variable backlash comp II Stroke position 1</b>
<p>Set the most plus (+) side stroke position among the three.  Set the parameters VBL2 P1 to P3 to be "VBL2 P1 &gt; VBL2 P2 &gt; VBL2 P3".  Normally, divide the axis's stroke by four, and set a dividing position (except for the both ends) to be a stroke position.</p> <p><b>---Setting range---</b>  -99999.999 to 99999.999 (mm)</p>		
<b>#2564</b>	<b>VBL2 P2</b>	<b>Variable backlash comp II Stroke position 2</b>
<p>Set the middle stroke position among the three.  Set the parameters VBL2 P1 to P3 to be "VBL2 P1 &gt; VBL2 P2 &gt; VBL2 P3".  Normally, divide the axis's stroke by four, and set a dividing position (except for the both ends) to be a stroke position.</p> <p><b>---Setting range---</b>  -99999.999 to 99999.999 (mm)</p>		
<b>#2565</b>	<b>VBL2 P3</b>	<b>Variable backlash comp II Stroke position 3</b>
<p>Set the most minus (-) side stroke position among the three.  Set the parameters VBL2 P1 to P3 to be "VBL2 P1 &gt; VBL2 P2 &gt; VBL2 P3".  Normally, divide the axis's stroke by four, and set a dividing position (except for the both ends) to be a stroke position.</p> <p><b>---Setting range---</b>  -99999.999 to 99999.999 (mm)</p>		
<b>#2566</b>	<b>VBL2 BL11</b>	<b>Variable backlash comp II Comp data at changeover spd 1 and stroke pos 1</b>
<p>Set the compensation data (backlash amount) at changeover speed 1 and stroke position 1.  Calculate the current compensation data according to the current speed and position.</p> <p><b>---Setting range---</b>  -99999999 to 99999999 (Machine error compensation unit)</p>		
<b>#2567</b>	<b>VBL2 BL12</b>	<b>Variable backlash comp II Comp data at changeover spd 1 and stroke pos 2</b>
<p>Set the compensation data (backlash amount) at changeover speed 1 and stroke position 2.  Calculate the current compensation data according to the current speed and position.</p> <p><b>---Setting range---</b>  -99999999 to 99999999 (Machine error compensation unit)</p>		
<b>#2568</b>	<b>VBL2 BL13</b>	<b>Variable backlash comp II Comp data at changeover spd 1 and stroke pos 3</b>
<p>Set the compensation data (backlash amount) at changeover speed 1 and stroke position 3.  Calculate the current compensation data according to the current speed and position.</p> <p><b>---Setting range---</b>  -99999999 to 99999999 (Machine error compensation unit)</p>		
<b>#2569</b>	<b>VBL2 BL01</b>	<b>Variable backlash comp II Comp data at changeover spd 2 and stroke pos 1</b>
<p>Set the compensation data (backlash amount) at changeover speed 2 and stroke position 1.  Calculate the current compensation data according to the current speed and position.</p> <p><b>---Setting range---</b>  -99999999 to 99999999 (Machine error compensation unit)</p>		

#2570	VBL2 BL02	Variable backlash comp II Comp data at changeover spd 2 and stroke pos 2	
Set the compensation data (backlash amount) at changeover speed 2 and stroke position 2. Calculate the current compensation data according to the current speed and position.			
---Setting range---			
-99999999 to 99999999 (Machine error compensation unit)			
#2571	VBL2 BL03	Variable backlash comp II Comp data at changeover spd 2 and stroke pos 3	
Set the compensation data (backlash amount) at changeover speed 2 and stroke position 3. Calculate the current compensation data according to the current speed and position.			
---Setting range---			
-99999999 to 99999999 (Machine error compensation unit)			
#2572	VBL2 FloatTC	Variable backlash comp II Time constant in calculating float amt	
Set the time constant in calculating the float amount. Set a value greater than the calculation cycle.			
---Setting range---			
0 to 10000 (ms)			
#2573	VBL2 LMMul	Variable backlash comp II Multiplier in calculating lost motion amt	
Set the multiplier in calculating the lost motion amount. When "1000" is set, the multiplier is "1".			
---Setting range---			
0 to 1000 (1/1000)			
#2574	VBL2 VBound	Variable backlash comp II Speed boundary value	
Set the boundary value of the speed in calculating the compensation amount.			
---Setting range---			
1 to 1000000 (mm/min)			
#2575	VBL2 CompMag	Variable backlash comp II Compensation magnification	
Set the compensation magnification in calculating the compensation amount. When "0" is set, the magnification is 100%.			
---Setting range---			
0 to 300(%)			
#2576	VBL2 CompMul	Variable backlash comp II Multiplier in calculating compensation amount	
Set the multiplier in calculating the compensation amount. When "1000" is set, the multiplier is "1".			
---Setting range---			
0 to 1000 (1/1000)			
#2577	VBL2 BLE	Variable backlash comp II Gradually increase amount	
Set the value to subtract from the compensation amount (CMP) at reversing the axis travel direction.			
---Setting range---			
-99999999 to 99999999 (Machine error compensation unit)			
#2578	VBL2 BLL	Variable backlash comp II Gradually increase travel distance	
Set the travel distance to return to the compensation amount (CMP) from the reverse point of the axis travel direction.			
---Setting range---			
0 to 99999.999 (mm)			
(PR)	#2580	index_Gcmd	Indexing axis G command check
The commanded G code of the index table indexing axis is checked.			
0: Check is not performed.			
1: Cutting feed G command is prohibited.			

#2584	VBL2 Vlimit	Variable backlash compensation 2: Speed to reset compensation scale to 100%	
<p>Specify the speed at which compensation scale is reset to 100%.                  When "0" is set, this parameter is disabled.                  If a set speed is greater than "#2574 VBL2 VBound", the speed is clamped at "#2574 VBL2 VBound".</p> <p>---Setting range---                  0 to 1000000 (mm/min)</p>			
#2598	G0tL_2	G0 time constant 2 (linear)	
<p>Set a linear control time constant for rapid traverse acceleration/deceleration to be applied when the G0 time constant switchover request signal is ON.</p> <p>This time constant is enabled when LR (rapid traverse feed with linear acceleration/deceleration) or F (soft acceleration/deceleration) is selected in "#2003 smgst" (Acceleration and deceleration modes).</p> <p>If #2598 is 0, the time constant set in "#2004 G0tL (G0 time constant)" will be used.</p> <p>---Setting range---                  0 to 4000(ms)</p>			
#2599	G0t1_2	G0 time constant 2 (primary delay)/2nd-step time constant for soft acceleration/deceleration	
<p>Set a primary-delay time constant for rapid traverse acceleration/deceleration to be applied when the G0 time constant switchover request signal is ON.</p> <p>This time constant is enabled when R1 (rapid traverse feed with primary delay) or R3 (exponential acceleration and linear deceleration) is selected in "#2003 smgst" (Acceleration and deceleration modes).</p> <p>When the soft acceleration/deceleration is selected, the second-step time constant will be used.</p> <p>If #2599 is set to 0, the time constant set in "#2005 G0t1 (G0 time constant (primary delay)/2nd-step time constant for soft acceleration/deceleration)" will be used.</p> <p>---Setting range---                  0 to 5000 (ms)</p>			
(PR)	#2614	JH_smgSel	Jog/handle acceleration/deceleration selection
<p>Switch jog/handle time constants. Set per axis.</p> <p>0: Not use                  1: (Not used)                  2: Enable for handle feed</p>			
#2616	JHtL	Jog/handle time constant (linear)	
<p>Set a linear control time constant for jog/handle feed acceleration/deceleration.                  When set to "0", the time constant will be clamped at 1 [ms].</p>			
<p>---Setting range---                  0 to 4000 (ms)</p>			
#2619	thr_clamp	Thread cut clamp speed	
<p>Specify the maximum cutting feed rate to be applied to thread cutting for each axis.</p> <p>---Setting range---                  1 to 1000000</p>			

<b>#2620</b>	<b>thr_t</b>	<b>Thread cut time constant</b>
Specify the primary delay time constant to be used in acceleration/deceleration of a thread cut axis.		
* This parameter is enabled when either C1 (Primary delay cutting feed) or LC (Linear acceleration/deceleration cutting feed) is selected for the acceleration/deceleration mode (#2003 smgst).		
<b>---Setting range---</b>		
0 to 4000		
<b>#2621</b>	<b>plrapid2</b>	<b>Rapid traverse rate for superimposition control 2</b>
Not used. Set to "0".		
<b>#2622</b>	<b>pl3G0tL</b>	<b>G0 time constant (linear) for 3-axis serial superimposition control</b>
Not used. Set to "0".		
<b>#2623</b>	<b>pl3G0t1</b>	<b>G0 time constant (primary delay) for 3-axis serial superimposition control</b>
Not used. Set to "0".		
<b>#2624</b>	<b>pl3G1tL</b>	<b>G1 time constant (linear) for 3-axis serial superimposition control</b>
Not used. Set to "0".		
<b>#2625</b>	<b>pl3G1t1</b>	<b>G1 time constant (primary delay) for 3-axis serial superimposition control</b>
Not used. Set to "0".		
<b>#2626</b>	<b>pl3rapid</b>	<b>Rapid traverse rate for 3-axis serial superimposition control</b>
Not used. Set to "0".		
<b>#2627</b>	<b>pl3rapid2</b>	<b>Rapid traverse rate for 3-axis serial superimposition control 2</b>
Not used. Set to "0".		
<b>#2628</b>	<b>pl3rapid3</b>	<b>Rapid traverse rate for 3-axis serial superimposition control 3</b>
Not used. Set to "0".		
<b>#2629</b>	<b>pl3clamp</b>	<b>Cutting feed clamp speed for 3-axis serial superimposition control</b>
Not used. Set to "0".		
<b>#2630</b>	<b>pl3clamp2</b>	<b>Cutting feed clamp speed for 3-axis serial superimposition control 2</b>
Not used. Set to "0".		
<b>#2631</b>	<b>G0olinps</b>	<b>Rapid traverse block overlap G00 in-position width</b>
Specify the in-position width for the rapid traverse block overlap at the joint of consecutively given G00 blocks.		
<b>---Setting range---</b>		
0.000 to 1000.000 (mm)		
<b>#2632</b>	<b>G1olinps</b>	<b>Rapid traverse block overlap G01 in-position width</b>
Specify the in-position width for the rapid traverse block overlap at the joint of two blocks where G01 is included.		
<b>---Setting range---</b>		
0.000 to 1000.000 (mm)		
<b>#2633</b>	<b>G28olinps</b>	<b>Rapid traverse block overlap G28 in-position width</b>
Specify the in-position width for the rapid traverse block overlap at the joint of two blocks where G28/G30 is included.		
<b>---Setting range---</b>		
0.000 to 1000.000 (mm)		



(PR)	#2634	SrvFunc01	
		<b>bit0: Change output units of servo axis cutting torque</b>	
		Change the output units of the servo axis cutting torque.	
		0: Output unit 1%	
		1: Output unit 0.01%	
		<b>bit1: Select stop method at collision detection</b>	
		Set the operation when a collision is detected.	
		0: Emergency stop.	
		1: Servo alarm occurs to an axis that the collision was detected.	
		The axes in the part system that the collision was detected will be in an automatic interlocked state.	
		Related parameters: SV035/bitE-C, SV035/bitB, SV060, CrshStpSel	
	#2639	tskip_T	<b>Non-sensitive band for torque skip</b>
		Specify a period of time in which torque skip condition is disabled. This is effective when an improper skip is generated due to current flown during acceleration (when G160 is commanded).	
		<b>---Setting range---</b>	
		0 to 32767(ms)	
	#2641	m_clamp	<b>Manual feed clamp speed</b>
		Specify the maximum speed to be applied to each axis when manual speed clamp is enabled.	
		When 0 is set, the rapid traverse rate (#2001 rapid) is applied.	
		<b>---Setting range---</b>	
		0 to 1000000 (mm/min)	
	#2642	jogfeed	<b>Jog feed rate</b>
		Specify a feed rate to be applied to each axis during jog mode.	
		When 0 is set, the manual feed rate selected by Manual feedrate method selection (JVS) signal is applied.	
		<b>---Setting range---</b>	
		0 to 1000000 (mm/min)	
(PR)	#2643	LdMeter thresholdY	<b>Loadmeter: Caution (Yellow) threshold</b>
		Specify the servo load current (%) at which the loadmeter displays a caution sign (yellow).	
		If servo load current exceeds the specified value, the loadmeter displays a caution (yellow).	
		If you wish to avoid showing the caution (yellow), set this parameter to be the same as "#2644 LdMeter thresholdR".	
		When "0" is set, the value becomes 100% (default).	
		<b>---Setting range---</b>	
		0 to 300(%)	
(PR)	#2644	LdMeter thresholdR	<b>Loadmeter: Warning (Red) threshold</b>
		Specify the servo load current (%) at which the loadmeter displays a warning sign (red).	
		If servo load current exceeds the specified value, the loadmeter displays a warning (red).	
		If you wish to avoid showing the warning (red), set this parameter to be the same as "#2645 LdMeter load max".	
		When "0" is set, the value becomes 150% (default).	
		<b>---Setting range---</b>	
		0 to 300(%)	
(PR)	#2645	LdMeter load max	<b>Loadmeter: Maximum servo load current</b>
		Specify the maximum servo load current (%) for loadmeter display.	
		When "0" is set, the value becomes 200% (default).	
		<b>---Setting range---</b>	
		0 to 300(%)	

	<b>#2646</b>	<b>distt</b>	<b>Load observation disturbance torque filter time constant</b>
	Not used. Set to "0".		
<b>(PR)</b>	<b>#2651</b>	<b>RT2G0</b>	<b>RT2: Minimum value of G0 acce/dece time constant</b>
	Not used.		
<b>(PR)</b>	<b>#2652</b>	<b>RT2G1</b>	<b>RT2: Enable switching of G1 acce/dece time constant</b>
	Not used.		
	<b>#2653</b>	<b>RT2G0tL</b>	<b>RT2: Minimum value of G0 acce/dece time constant</b>
	Not used.		
	<b>#2654</b>	<b>RT2G1tLA</b>	<b>RT2: Minimum value of acce/dece time constant after G1 interpolation</b>
	Not used.		
	<b>#2655</b>	<b>RT2G1tLB</b>	<b>RT2: Minimum value of acce/dece time constant before G1 interpolation</b>
	Not used.		
	<b>#2656</b>	<b>RT2 G0rng</b>	<b>RT2: Changing amount of G0 acce/dece time constant</b>
	Not used.		
	<b>#2657</b>	<b>RT2G1rngA</b>	<b>RT2: Changing amount of acce/dece time constant after G1 interpolation</b>
	Not used.		
	<b>#2658</b>	<b>RT2G1rngB</b>	<b>RT2: Changing amount of acce/dece time constant before G1 interpolation</b>
	Not used.		
	<b>#2659</b>	<b>tolerance</b>	<b>Tolerance</b>
	Specify a tolerance (tolerable error) to be used under tolerance control. Set a tolerable error for fine segment program created by CAM. (Usually around 0.01(mm)) If 0.000 is set, it is operated with the tolerance of 0.01(mm). When designating the tolerance amount with the ", K address", this parameter is not used.		
	<b>---Setting range---</b>		
	0.000 to 100.000 (mm)		
	<b>#2660</b>	<b>omrff_inps</b>	<b>OMR-FF in-position width</b>
	Specify the in-position width at which the standard model gain is switched under OMR-FF control. When set to "0", command deceleration check is performed.		
	<b>---Setting range---</b>		
	0.000 to 99.999 (mm)		
	<b>#2661</b>	<b>ITF3_ILMT</b>	<b>Interference check III torque limit at entering interference warning area</b>
	Not used.		
	<b>#2662</b>	<b>ITF3_Clamp</b>	<b>Interference check III clamp speed at entering interference warning area</b>
	Not used.		
	<b>#2663</b>	<b>IDD CauThreshold</b>	<b>Motor insulation deterioration: Caution threshold</b>
	Set the threshold so that "Z38 Insulation deterioration wrn 0001" could occur. When performing the insulation deterioration detection and the detected value falls below the parameter setting value, "Z38 Insulation deterioration wrn 0001" occurs.		
	If "0" is set, the standard value (100[0.1 megohm]) will be applied.		
	<b>---Setting range---</b>		
	0 to 300 (0.1 megohm)		

#2664	IDD ChgThreshold	Motor insulation deterioration: Replacement threshold
	<p>Set the threshold so that "Z38 Insulation deterioration wrn 0002" could occur. When performing the insulation deterioration detection and the detected value falls below the parameter setting value, "Z38 Insulation deterioration wrn 0002" occurs.</p>	
	<p>If "0" is set, the standard value (10[0.1 megohm]) will be applied.</p>	
	<p><b>---Setting range---</b></p>	
	<p>0 to 300 (0.1 megohm)</p>	

## 16.5 Zero Point Return Parameters

#2025	G28rap	G28 rapid traverse rate
		Set a rapid traverse rate for the dog type reference position return command. This is not used for the distance-coded reference position detection.
		<b>---Setting range---</b> 1 to 1000000 (mm/min)
#2026	G28crp	G28 approach speed
		Set up the speed of approach to the reference point in the reference point return command. This speed is attained after the system stops with deceleration by dog detection. In the distance-coded reference position detection, the set value will be applied from the start of reference position establishment. (Note) The G28 approach speed unit is (10°/min) only when using the Z-phase type encoder (#1226 aux10/bit3=1) for the spindle/C-axis reference position return type. The same unit is used for both the micrometric and sub-micrometric specifications.
		<b>---Setting range---</b> 1 to 60000 (mm/min)
#2027	G28sft	Reference position shift distance
		Set the distance from the electrical zero-point detection position to the reference position. This is not used for the distance-coded reference position detection.  (Note 1) When "#1240 set12/bit2" is ON, a magnification (C: 10-fold, D: 100-fold and E: 1000-fold) corresponding to the input setting unit ("#1003 iunit") will be applied to the setting value. (Note 2) The sign of setting value is will be following: the direction of "#2030 dir (-)" Reference position direction (-) is plus, and the opposite direction is minus. (Note 3) When set value is set to minus, the axis moves to electrical zero-point detection position at first and then moves in opposite direction.
		<b>---Setting range---</b> -99.999 to +99.999 (mm)
#2028	grmask	Grid mask amount
		Set the distance where the grid point will be ignored when near-point dog OFF signals are close to that grid point during reference position return.

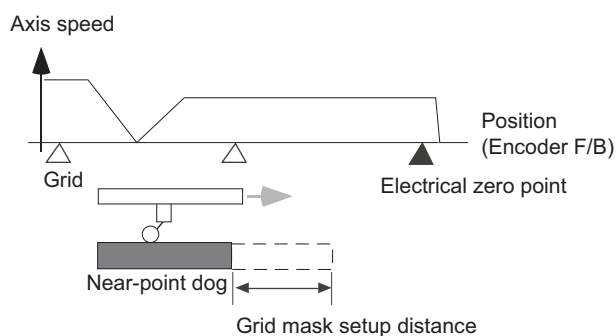

The grid mask is valid for one grid.

This is not used for the distance-coded reference position detection.

**---Setting range---**  
0.000 to 99.999 (mm)

#2029	grspc	Grid interval
-------	-------	---------------

Set the distance between grids.

Generally, set up the value equal to the ball screw pitch. However, if the encoder grid interval is not equal to the screw pitch when measured with a linear scale, set up the encoder grid interval.

To make the grid space smaller, set a divisor of the grid space.

This is not used for the distance-coded reference position detection.

(Note) Set the grid interval "#2029 grspc" according to the reference encoder for grid interval "#2041 grspc-ref".

(1) Semi-closed loop control

If "#2041 grspc-ref" is set to "0" (grid interval by the motor-side), set "#2029 grspc" to the same value as the ball screw pitch.

If "#2041 grspc-ref" is set to "1" (grid interval by the machine-side), set "#2029 grspc" to the moving amount calculation value per a motor rotation (" $\#2201 \text{ SV001 PC1} / \#2202 \text{ SV002 PC2} \times \#2218 \text{ SV018 PIT}$ ").

(2) Full-closed loop control

If "#2041 grspc-ref" is set to "1" (grid interval by the machine-side), set "#2029 grspc" to the same value as the Z phase pitch.

If "#2041 grspc-ref" is set to "0" (grid interval by the motor-side), set "#2029 grspc" to the moving amount calculation value per Z phase pitch (" $\#2202 \text{ SV002 PC2} / \#2201 \text{ SV001 PC1} \times$  the Z phase pitch of the machine-side").

(\* If "#2029 grspc" is set to "0", the ball screw pitch "#2218 SV018 PIT" is used instead of the grid interval.

---Setting range---

0.000 to 999.999 (mm)

(PR)	#2030	dir (-)	Reference position direction (-)
------	-------	---------	----------------------------------

Select which side of the near-point dog the reference position is established.

For a rotary axis, select a direction that heads to the zero point from the intermediate point during automatic zero point return.

0: Positive direction

1: Negative direction

Directions in which reference position is established as viewed from the near-point dog

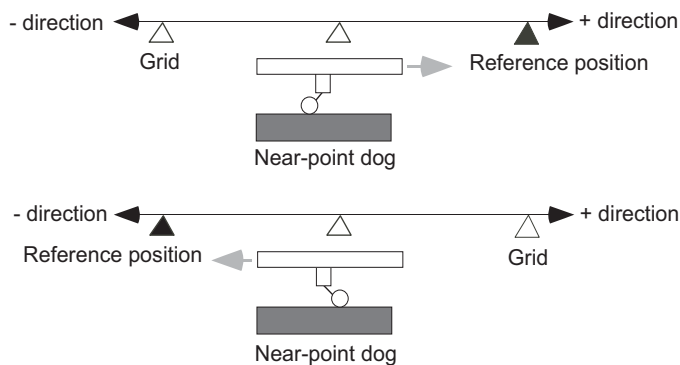

#2031	noref	Axis without reference position
-------	-------	---------------------------------

Select whether the reference position is provided for the axis.

0: Reference position is provided. (Normal controlled axis)

1: No reference position is provided.

When "1" is set, reference position return is not required before automatic operation starts.

	<b>#2032</b>	<b>nochk</b>	<b>Whether reference position return is completed not checked</b>
	<p>Select whether to check the reference position return completion.</p> <p>0: Check the reference position return completion.</p> <p>1: Not check the reference position return completion.</p> <p>When "1" is set, the absolute and incremental commands can be executed even if dog type (or Z phase pulse system) reference position return is not completed.</p> <p>Note that this setting is available for a rotary axis only.</p>		
<b>(PR)</b>	<b>#2033</b>	<b>zp_no</b>	<b>Z phase pulse system reference position return spindle encoder No.</b>
	Not used. Set to "0".		
<b>(PR)</b>	<b>#2034</b>	<b>rfpofs</b>	<b>Distance-coded reference position detection offset</b>
	Not used. Set to "0.000".		
	<b>#2035</b>	<b>srchmax</b>	<b>Distance-coded reference position detection scan distance</b>
	Not used. Set to "0.000".		

<b>#2036</b>	<b>slv_adjust</b>	<b>Reference position adjustment value</b>
--------------	-------------------	--

Set the distance from the first grid point after leaving the near point dog on the slave axis to the position where the reference position is actually established in dog-type reference position return in synchronous control. (Reference position shift amount is not included.)

The adjustment value will be automatically set in the slave axis's parameter according to the reference position adjustment complete signal from PLC.

Fine adjustment is also available from the parameter screen.

In the distance-coded reference position detection, the reference position adjustment value will be invalid.

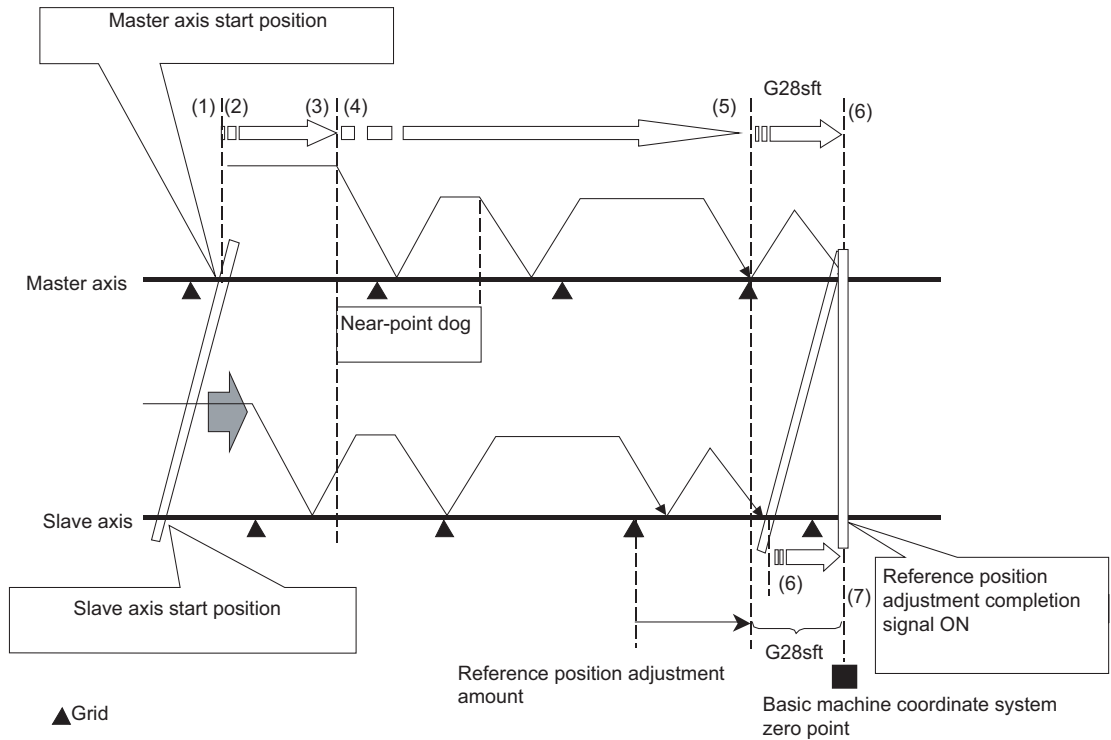

(Note 1) This parameter is enabled when the synchronization at zero point initialization ("#1493 ref\_syn" = "1" of the master axis) is applied.

(Note 2) This parameter can be set when one of the following settings is applied.

- Relative position detection ("#2049 type" = "0")
- Dog-type absolute position detection ("#2049 type" = "3")
- Simple absolute position ("#2049 type" = "9")

(Note 3) Set "0" when using the speed/current command synchronization control.

(Note 4) A setting unit of this parameter is [mm]. It is not influenced by the content of the following parameters setting.

- "#1003 iunit"
- "#1004 ctrl\_unit"
- "#1005 plcunit"
- "#1040 M\_inch"
- "#1041 I\_inch"
- "#1240 set12/bit2" (Zero point shift amount magnification)

(Note 5) The number of the significant digits after decimal point follows "#1004 ctrl\_unit".

(Note 6) A change of this parameter requires reference position return. When the automatic operation starts without reference position return, an alarm will occur.

**---Setting range---**

0 to 99999.999999 (mm)

**#2037      G53ofs      Reference position #1**

Set the position of the first reference position from the zero point of the basic machine coordinate.

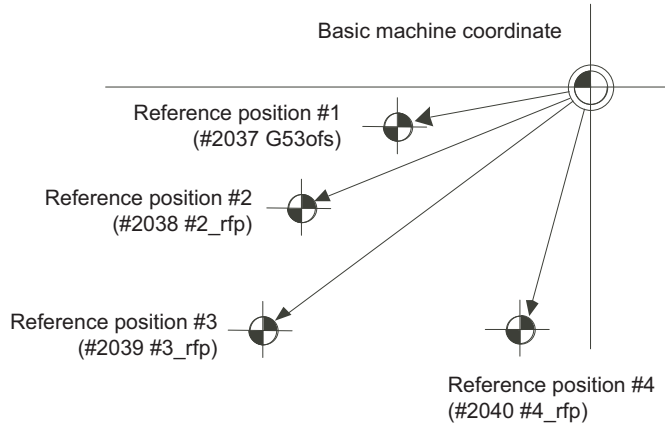

---Setting range---

-99999.999 to 99999.999 (mm)

**#2038      #2\_rfp      Reference position #2**

Set the position of the second reference position from the zero point of the basic machine coordinate.

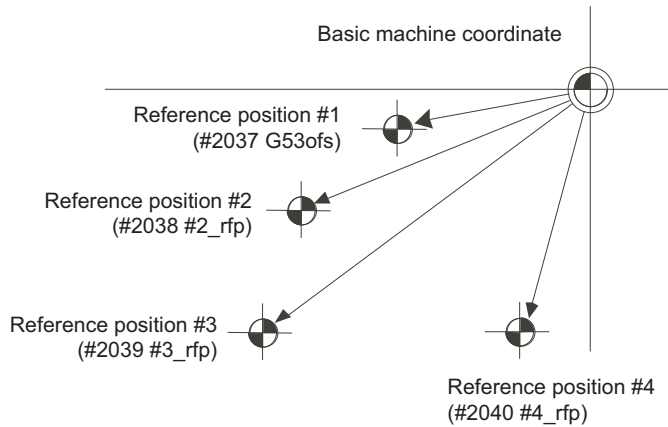

---Setting range---

-99999.999 to 99999.999 (mm)

**#2039      #3\_rfp      Reference position #3**

Set the position of the third reference position from the zero point of the basic machine coordinate.

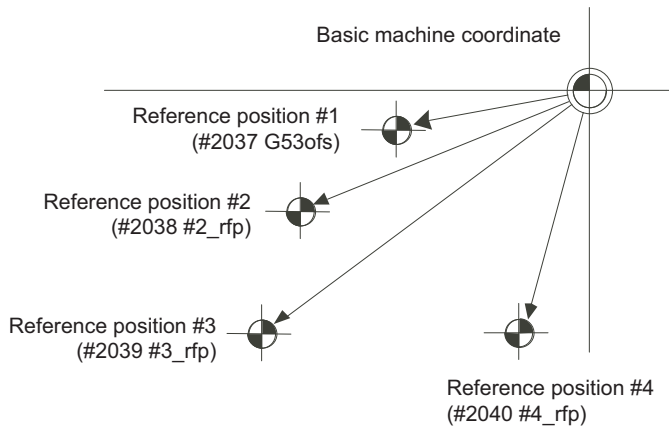

---Setting range---

-99999.999 to 99999.999 (mm)



**#2040      #4\_rfp      Reference position #4**

Set the position of the fourth reference position from the zero point of the basic machine coordinate.

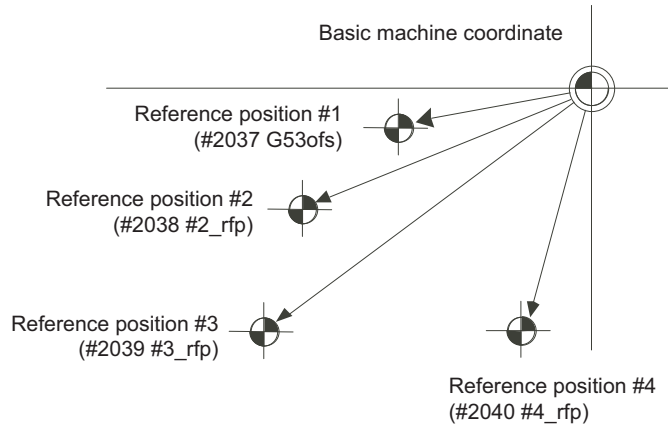

**---Setting range---**

-99999.999 to 99999.999 (mm)

**#2041      grspcref      Reference encoder for grid interval**

Not used.

## 16.6 Absolute Position Detection Parameters

(PR)	#2049	type	Absolute position detection method
			<p>Select the absolute position zero point alignment method.</p> <p>0: Not absolute position detection</p> <p>1: Stopper method (push against mechanical stopper)</p> <p>2: Marked point alignment method I (The grid point is the reference position.)</p> <p>3: Dog-type (align with dog and near point detection switch)</p> <p>4: Marked point alignment method II (The position with which the mark was aligned is the reference position.)</p> <p>5: Grid-on method (position on the nearest grid point)</p> <p>9: Simple absolute position (Not absolute position detection, but the position when the power is turned off is registered.)</p>
	#2050	absdir	Basic point of Z direction
			<p>Select the direction of the grid point immediately before the machine basic position (basic point of encoder) in the marked point alignment.</p> <p>0: Positive direction</p> <p>1: Negative direction</p>
	#2051	check	Check
			<p>Set the tolerable range of travel distance (deviation distance) while the power is turned OFF.</p> <p>If the distance between the position when the power is turned OFF and when the power is turned ON again is larger than the set value, the information is notified to the PLC. (signal name: Absolute position warning)</p> <p>Set "0" to omit the check.</p> <p>---Setting range---</p> <p>0 to 99999.999 (mm)</p>
	#2054	clipush	Current limit (%)
			<p>Set the current limit value during the stopper operation in the dogless-type absolute position detection.</p> <p>The setting value is the ratio of the current limit value to the rated current value.</p> <p>---Setting range---</p> <p>0 to 100 (%)</p>
	#2055	pushf	Push speed
			<p>Set the feedrate for the automatic initial setting during stopper method.</p> <p>---Setting range---</p> <p>1 to 999 (mm/min)</p>
	#2056	aproch	Approach
			<p>Set the approach distance of the stopper when deciding the absolute position basic point with the stopper method.</p> <p>After using stopper once, the tool returns with this distance, and then use stopper again.</p> <p>---Setting range---</p> <p>0 to 999.999 (mm)</p>
	#2057	nrefp	Near zero point +
			<p>Set the positive direction width where the near reference position signal is output.</p> <p>When set to "0", the value is the same as #2218 SV018(PIT).</p> <p>(Note) When "#1240 set12/bit2" is ON, a magnification (C: 10-fold, D: 100-fold, E: 1000-fold) corresponding to the input setting increment ("#1003 iunit") will be applied to the setting value.</p> <p>---Setting range---</p> <p>0 to 999.999 (mm)</p> <p>(Input setting increment applied)</p>

#2058	nrefn	Near zero point -
<p>Set the negative direction width where the near reference position signal is output.            When set to "0", the value is the same as #2218 SV018(PIT).            (Note) When "#1240 set12/bit2" is ON, a magnification (C: 10-fold, D: 100-fold, E: 1000-fold) corresponding to the input setting increment ("#1003 iunit") will be applied to the setting value.</p> <p>---Setting range---</p> <p>0 to 999.999 (mm)            (Input setting increment applied)</p>		
#2059	zerbas	Select zero point parameter and basic point
<p>Select which is to be the zero point coordinate position during absolute position initial setting.</p> <p>0: Position where the axis was stopped.            1: Grid point just before stopper.</p>		

## 16.7 Servo Parameters

<b>(PR)</b>	<b>#2201</b>	<b>SV001 PC1</b>	<b>Motor side gear ratio</b>
			<p>Set the gear ratio in the motor side when there is the gear between the servo motor's shaft and machine (ball screw, etc.). For the rotary axis, set the total deceleration (acceleration) ratio. Even if the gear ratio is within the setting range, the electronic gears may overflow and an initial parameter error (servo alarm 37) may occur.</p> <p>For linear servo system Set to "1".</p> <p><b>---Setting range---</b> 1 to 32767</p>
<b>(PR)</b>	<b>#2202</b>	<b>SV002 PC2</b>	<b>Machine side gear ratio</b>
			<p>Set the gear ratio in the machine side when there is the gear between the servo motor's shaft and machine (ball screw, etc.). For the rotary axis, set the total deceleration (acceleration) ratio. Even if the gear ratio is within the setting range, the electronic gears may overflow and an initial parameter error (servo alarm 37) may occur.</p> <p>For linear servo system Set to "1".</p> <p><b>---Setting range---</b> 1 to 32767</p>
	<b>#2203</b>	<b>SV003 PGN1</b>	<b>Position loop gain 1</b>
			<p>Set the position loop gain. The standard setting is "33". The higher the setting value is, the more accurately the command can be followed, and the shorter the settling time in positioning gets, however, note that a bigger shock will be applied to the machine during acceleration/deceleration. When using the SHG control, also set SV004 (PGN2) and SV057 (SHGC).</p> <p>When using the OMR-FF control, set the servo rigidity against quadrant projection or cutting load, etc. For the tracking ability to the command, set by SV106(PGM).</p> <p><b>---Setting range---</b> 1 to 200 (rad/s)</p>
	<b>#2204</b>	<b>SV004 PGN2</b>	<b>Position loop gain 2</b>
			<p>When performing the SHG control, set the value of "SV003 x 8/3" to "SV004". When not using the SHG control, set to "0". When using the OMR-FF control, set to "0".</p> <p>Related parameters: SV003, SV057</p> <p><b>---Setting range---</b> 0 to 999 (rad/s)</p>
	<b>#2205</b>	<b>SV005 VGN1</b>	<b>Speed loop gain 1</b>
			<p>Set the speed loop gain. The higher the setting value is, the more accurate the control will be, however, vibration tends to occur. If vibration occurs, adjust by lowering by 20 to 30%. The value should be determined to the 70 to 80% of the value at which the vibration stops. The value differs depending on servo motors. Aim at the standard value determined by the servo motor type and load inertia ratio to adjust.</p> <p><b>---Setting range---</b> 1 to 30000</p>

<b>#2206</b>	<b>SV006 VGN2</b>	<b>Speed loop gain 2</b>
--------------	-------------------	--------------------------

Set the speed loop gain at the motor limitation speed VLMT (maximum rotation speed x 1.15) with "VCS(SV029: Speed at the change of speed loop gain)".  
 Use this to suppress noise at high speed rotation during rapid traverse, etc. Then, the speed loop gain decreases at faster speed than the setting value of VCS. When not using, set to "0".

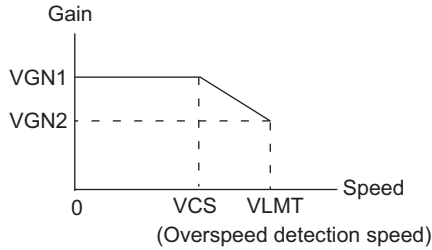

**---Setting range---**

-1000 to 30000

<b>#2207</b>	<b>SV007 VIL</b>	<b>Speed loop delay compensation</b>
--------------	------------------	--------------------------------------

Set this when the limit cycle occurs in the full-closed loop, or overshooting occurs in positioning. The speed loop delay compensation method can be selected with SV027/bit1,0.  
 Normally, use "Changeover type 2". Changeover type 2 controls the occurrence of overshooting by lowering the speed loop lead compensation after the position droop gets 0.  
 When setting this parameter, make sure to set the torque offset (SV032).

**---Setting range---**

0 to 32767

<b>#2208</b>	<b>SV008 VIA</b>	<b>Speed loop lead compensation</b>
--------------	------------------	-------------------------------------

Set the gain of the speed loop integral control.  
 Standard setting: 1364  
 Standard setting in the SHG control: 1900  
 Adjust the value by increasing/decreasing this by about 100 at a time.  
 Raise this value to improve contour tracking accuracy in high-speed cutting.  
 Lower this value when the position droop does not stabilize (when the vibration of 10 to 20Hz occurs).

**---Setting range---**

1 to 9999

<b>#2209</b>	<b>SV009 IQA</b>	<b>Current loop q axis lead compensation</b>
--------------	------------------	--

Set the fixed value of each motor.  
 Set the standard value for each motor described in the standard parameter list.

**---Setting range---**

1 to 20480

<b>#2210</b>	<b>SV010 IDA</b>	<b>Current loop d axis lead compensation</b>
--------------	------------------	--

Set the fixed value of each motor.  
 Set the standard value for each motor described in the standard parameter list.

**---Setting range---**

1 to 20480

<b>#2211</b>	<b>SV011 IQG</b>	<b>Current loop q axis gain</b>
--------------	------------------	---------------------------------

Set the fixed value of each motor.  
 Set the standard value for each motor described in the standard parameter list.

**---Setting range---**

1 to 8192

<b>#2212</b>	<b>SV012 IDG</b>	<b>Current loop d axis gain</b>
--------------	------------------	---------------------------------

Set the fixed value of each motor.  
 Set the standard value for each motor described in the standard parameter list.

**---Setting range---**

1 to 8192

#2213	SV013 ILMT	Current limit value
		<p>Set the current (torque) limit value in a normal operation.  This is a limit value in forward run and reverse run (for linear motors: forward and reverse direction).  When the standard setting value is "800", the maximum torque is determined by the specification of the motor.  Set this parameter as a proportion (%) to the stall current.</p> <p><b>---Setting range---</b>  0 - 999 (Stall current %)</p>
#2214	SV014 ILMTsp	Current limit value in special control
		<p>Set the current (torque) limit value in a special operation (absolute position initial setting, stopper control and etc.).  This is a limit value in forward and reverse directions.  Set to "800" when not using.  Set this parameter as a proportion (%) to the stall current.</p> <p><b>---Setting range---</b>  0 - 999 (Stall current %)  However, when SV084/bitB=1, the setting range is from 0 to 32767 (Stall current 0.01%).</p>
#2215	SV015 FFC	Acceleration rate feed forward gain
		<p>When a relative error in synchronous control is too large, set this parameter to the axis that is delaying.  The standard setting is "0". The standard setting in the SHG control is "100".  To adjust a relative error in acceleration/deceleration, increase the value by 50 at a time.</p> <p><b>---Setting range---</b>  0 to 999 (%)</p>
#2216	SV016 LMC1	Lost motion compensation 1
		<p>Set this parameter when the protrusion (that occurs due to the non-sensitive band by friction, torsion, backlash, etc.) at quadrant change is too large. This sets the compensation torque at quadrant change (when an axis feed direction is reversed) by the proportion (%) to the stall torque. Whether to enable the lost motion compensation and the method can be set with other parameters.</p> <p>Type 2: When SV027/bit9, 8=10 (Compatible with obsolete type)  Set the type 2 method compensation torque. The standard setting is double the friction torque.  Related parameters: SV027/bit9,8, SV033/bitF, SV039, SV040, SV041, SV082/bit2</p> <p>Type 3: When SV082/bit1=1  Set the compensation torque equivalent of dynamic friction amount of the type 3 method compensation amount. The standard setting is double the dynamic friction torque.  Related parameters: SV041, SV082/bit2,1, SV085, SV086</p> <p>To vary compensation amount according to the direction.  When SV041 (LMC2) is "0", compensate with the value of SV016 (LMC1) in both +/-directions.  If you wish to change the compensation amount depending on the command direction, set this and SV041 (LMC2).  (SV016: + direction, SV041: - direction. However, the directions may be opposite depending on other settings.)  When "-1" is set, the compensation will not be performed in the direction of the command.</p> <p><b>---Setting range---</b>  -1 to 200 (Stall current %)  Note that when SV082/bit2 is "1", the setting range is between -1 and 20000 (Stall current 0.01%).</p>

(PR)	#2217	SV017 SPEC1	Servo specification 1
------	-------	-------------	-----------------------

Select the servo specifications.  
 A function is allocated to each bit.  
 Set this in hexadecimal format.

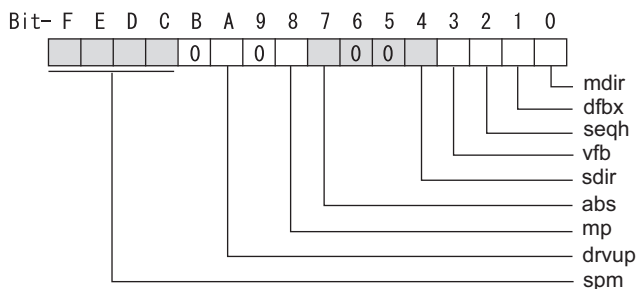

**bit F-C : spm Motor series selection**

- 0: Not used
- 1: 200V HG motor (Standard)
- 2: Not used
- 3: 400V HG-H, HQ-H motor (Standard)
- 6: 200V LM-F linear motor
- 7: 200V direct-drive motor
- 8: 400V LM-F linear motor
- 9: 400V direct-drive motor

**bit B :**

Not used. Set to "0".

**bit A : drvup Combined drive unit:**

- 0: Normal setting (Combined drive unit: normal)
  - 1: Combined drive unit: one upgrade
- (Note) It is not available for MDS-EJ/EJH Series.

**bit 9 :**

Not used. Set to "0".

**bit 8 : mp MPI scale pole number setting**

- 0: 360 poles 1: 720 poles

**bit 7 : abs Position control**

These parameters are set automatically by the NC system.  
 0: Incremental 1: Absolute position control

**bit 6-5 :**

Not used. Set to "0".

**bit 4 : sdir Sub side encoder feedback**

Set the machine side encoder's installation polarity.  
 0: Forward polarity 1: Reverse polarity

**bit 3 : vfb Speed feedback filter**

- 0: Stop 1: Start (4500Hz)

**bit 2 : seqh Ready on sequence**

- 0: Normal 1: High-speed

**bit 1 : dfbx Dual feedback control**

Control the position FB signal in full closed control by the combination of a motor side encoder and machine side encoder.  
 0: Stop 1: Start

Related parameters: SV051, SV052

**bit 0 : mdir Machine side encoder feedback (for Linear/direct-drive motor)**

Set the encoder installation polarity in the linear servo and direct-drive motor control.  
 0: Forward polarity 1: Reverse polarity

(PR)	#2218	SV018 PIT	Ball screw pitch/Magnetic pole pitch
			<p>For servo motor: Set the ball screw pitch. For the rotary axis, set to "360".</p> <p>For direct-drive motor Set to "360".</p> <p>For linear motor Set the ball screw pitch. (For LM-F series, set to "48")</p> <p><b>---Setting range---</b></p> <p>For general motor: 1 to 32767 (mm/rev) - For linear motor 1 to 32767 (mm)</p>
(PR)	#2219	SV019 RNG1	Sub side encoder resolution
			<p>For semi-closed loop control Set the same value as SV020.</p> <p>For full-closed loop control Set the number of pulses per ball screw pitch.</p> <p>For direct-drive motor Set the same value as SV020.</p> <p>For 1000 pulse unit resolution encoder, set the number of pulses in SV019 in increments of 1000 pulse (kp). The value must be input in increments of 10K pulses (the 1st digit of the setting value is "0"). In this case, make sure to set "0" to SV117. For high-accuracy binary resolution encoder, set the number of pulses to four bite data of SV117 (high-order) and SV019 (low-order) in pulse (p) unit. SV117 = number of pulses / 65536 (when =0, set "-1" to SV117) SV019 = the remainder of number of "pulses / 65536"</p> <p><b>---Setting range---</b></p> <p>When SV117 = 0, the setting range is from 0 to 32767 (kp) When SV117≠0, the setting range is from 0 to 65535 (p)</p>
(PR)	#2220	SV020 RNG2	Main side encoder resolution
			<p>Normally, set to "0".</p> <p>For linear motor Set the number of pulses of the encoder per magnetic pole pitch with SV118.</p> <p>For direct-drive motor Set the number of pulses per revolution of the motor side encoder.</p> <p>For 1000 pulse unit resolution encoder, set the number of pulses to SV020 in increments of 1000 pulse(kp). The value must be input in increments of 10K pulses (the 1st digit of the setting value is "0"). In this case, make sure to set SV118 to "0". For high-accuracy binary resolution encoder, set the number of pulses to four bite data of SV118 (high-order) and SV020 (low-order) in pulse(p) unit. SV118 = number of pulses / 65536 (when =0, set "-1" to SV118) SV020 = the remainder of "number of pulses / 65536"</p> <p><b>---Setting range---</b></p> <p>When SV118 = 0, the setting range is from 0 to 32767 (kp) When SV118≠0, the setting range is from 0 to 65535 (p)</p>
#2221	SV021 OLT	Overload detection time constant	
			<p>Normally, set to "60". (For Mitsubishi Electric adjustment.)</p> <p>Related parameters: SV022</p> <p><b>---Setting range---</b></p> <p>1 to 999 (s)</p>



#2222	SV022 OLL	Overload detection level
	Set the "Overload 1" (Alarm 50) current detection level as percentage to the stall current. Normally set this parameter to "150". (For Mitsubishi Electric adjustment.)  Related parameters: SV021 <b>---Setting range---</b> 110 to 500 (Stall current %)	
#2223	SV023 OD1	Excessive error detection width during servo ON
	Set the excessive error detection width in servo ON. When set to "0", the excessive error alarm detection will be ignored, so do not set to "0". <Standard setting value> $OD1=OD2= (\text{Rapid traverse rate [mm/min]} / (60 \times \text{PGN1}) / 2 \text{ [mm]})$  Related parameters: SV026 <b>---Setting range---</b> 0 to 32767 (mm) However, when SV084/bitC=1, the setting range is from 0 to 32767 (μm).	
#2224	SV024 INP	In-position detection width
	Set the in-position detection width. Set the positioning accuracy required for the machine. The lower the setting is, the higher the positioning accuracy will be. However the cycle time (settling time) becomes longer. The standard setting value is "50". <b>---Setting range---</b> 1 to 32767 (μm)	
(PR) #2225	SV025 MTPY	Motor/Encoder type

Set the position encoder type, speed encoder type and motor type.  
 The setting value is a four-digit hex (HEX).

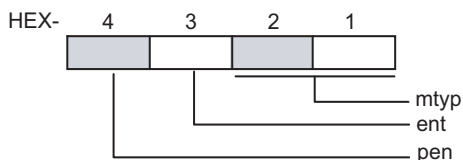

**bit F-C: pen(HEX-4) Position encoder**

Semi-closed loop control by general motor  
 pen=2

Full-closed loop control by general motor

- Ball screw end encoder (OSA405ET2AS, OSA676ET2AS)  
pen=6
- For serial signal output rotary scale (including MDS-EX-HR)  
pen=6
- For rectangular wave signal output linear scale  
pen=8
- For serial signal output linear scale (including MDS-EX-HR and MPI scale)  
pen=A
- For speed command synchronization control  
Primary axis pen=A  
Secondary axis pen=D

For linear motor  
 pen=A

For direct-drive motor  
 pen=2

**bit B-8: ent(HEX-3) Speed encoder**

- For general motor: ent=2
- For linear motor: ent=A
- For direct-drive motor: ent=2

**bit 7-0: mtyp(HEX-2,1) Motor type**

Set the motor type. Set this with SV017/bitF-C.

For SV017/bitF-C = 1 (200V standard motor series)

HG75	: 41h	HG123	: 64h
HG105	: 42h	HG142	: 65h
HG54	: 43h	HG46	: BAh
HG104	: 44h	HG56	: BBh
HG154	: 45h 4Fh(Note 1)	HG96	: BCh
HG224	: 46h		
HG204	: 47h		
HG354	: 48h		
HG223	: 66h		
HG303	: 68h		
HG453	: 49h		
HG603	: 69h		
HG702	: 6Ah		
HG703	: 4Ah		
HG903	: 4Bh		
HG1103	: 4Ch		
HG302	: 67h		

(Note 1) When MDS-E-V3 is connected

For SV017/bitF-C = 3 (400V standard motor series)

HG-H75	: 41h	HQ-H903	: 58h
HG-H105	: 42h	HQ-H1103	: 59h
HG-H54	: 43h		
HG-H104	: 44h		
HG-H154	: 45h		
HG-H224	: 46h		
HG-H204	: 47h		
HG-H354	: 48h		
HG-H453	: 49h		
HG-H703	: 4Ah		
HG-H903	: 4Bh		
HG-H1502	: 4Dh		

For linear motor and direct-drive motor, follow the settings stated in respective materials.

---

<b>#2226</b>	<b>SV026 OD2</b>	<b>Excessive error detection width during servo OFF</b>
--------------	------------------	---

---

Set the excessive error detection width during servo OFF.

When set to "0", the excessive error alarm detection will be ignored, so do not set to "0".

<Standard setting value>

$$OD1=OD2=(\text{Rapid traverse rate [mm/min]}) / (60 \times \text{PGN1}) / 2 \text{ [mm]}$$

Related parameters: SV023

**---Setting range---**

0 to 32767 (mm)

However, when SV084/bitC=1, the setting range is from 0 to 32767 (μm).

<b>#2227</b>	<b>SV027 SSF1</b>	<b>Servo function 1</b>
--------------	-------------------	-------------------------

Select the servo functions.  
 A function is assigned to each bit.  
 Set this in hexadecimal format.

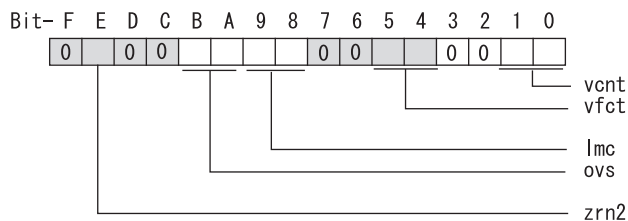

**bit F :**

Not used. Set to "0".

**bit E : zrn2**

Set to "1". (Fixed)

**bit D :**

Not used. Set to "0".

**bit C :**

Not used. Set to "0".

**bit B-A : ovs Overshooting compensation**

Set this if overshooting occurs during positioning.

bitB,A=

00: Compensation stop

01: Setting prohibited

10: Setting prohibited

11: Type 3

Set the compensation amount in SV031(OVS1) and SV042(OVS2).

Related parameters: SV031, SV042, SV034/bitF-C

**bit 9-8 : lmc Lost motion compensation type**

Set this parameter when the protrusion at quadrant change is too large.

Type 2 has an obsolete type compatible control.

bit9,8=

00: Compensation stop

01: Setting prohibited

10: Type 2

11: Setting prohibited

Set the compensation amount in SV016(LMC1) and SV041(LMC2).

(Note) When "SV082/bit1=1", the lost motion compensation type 3 will be selected regardless of this setting.

**bit 7 :**

Not used. Set to "0".

**bit 6 :**

Not used. Set to "0".

**bit 5-4 : vfct Jitter compensation pulse number**

Suppress vibration by machine backlash when axis stops.

bit5,4=

00: Disable

01: 1 pulse

10: 2 pulse

11: 3 pulses

**bit 3 :**

Not used. Set to "0".

**bit 2 :**

Not used. Set to "0".

**bit 1-0 : vcnt Speed loop delay compensation changeover type selection**

Normally, use "Changeover type 2".  
 bit1,0=  
 00: Disable  
 01: Changeover type 1  
 10: Changeover type 2  
 11: Setting prohibited

Related parameters: SV007

<b>(PR)</b>	<b>#2228</b>	<b>SV028 MSFT</b>	<b>Magnetic pole shift amount (for linear/direct-drive motor)</b>
-------------	--------------	-------------------	---

Set this parameter to adjust the motor magnetic pole position and encoder's installation phase when using linear motors or direct-drive motors.  
 During the DC excitation of the initial setup (SV034/bit4=1), set the same value displayed in "AFLT gain" on the NC monitor screen.

Related parameters: SV034/bit4, SV061, SV062, SV063

For general motor:  
 Not used. Set to "0".

**---Setting range---**

-18000 to 18000 (electrical angle 0.01°)

<b>#2229</b>	<b>SV029 VCS</b>	<b>Speed at the change of speed loop gain</b>
--------------	------------------	---

Noise at high speed rotation including rapid traverse can be reduced by lowering the speed loop gain at high speeds.  
 Set the speed at which the speed loop gain changes. Use this with SV006 (VGN2).  
 When not using, set to "0".

**---Setting range---**

0 to 9999 (r/min)

<b>#2230</b>	<b>SV030 IVC</b>	<b>Voltage non-sensitive band compensation</b>
--------------	------------------	--

When 100% is set, the voltage reduction amount equivalent to the logical non-energization in the PWM control will be compensated.  
 When "0" is set, 100% compensation will be performed.  
 Adjust in increments of 10% from the default value of 100%.  
 If increased too much, vibration or vibration noise may be generated.

**---Setting range---**

0 to 255 (%)

<b>#2231</b>	<b>SV031 OVS1</b>	<b>Overshooting compensation 1</b>
--------------	-------------------	------------------------------------

This compensates the motor torque when overshooting occurs during positioning. This is valid only when the overshooting compensation (SV027/bitB,A) is selected.

Type 3 SV027/bitB,A=11

Set the compensation amount based on the motor stall current. Observing positioning droop waveform, increase in increments of 1% and find the value where overshooting does not occur.

To vary compensation amount depending on the direction.

When SV042 (OVS2) is "0", change the SV031 (OVS1) value in both of the +/- directions to compensate. To vary the compensation amount depending on the command direction, set this and SV042 (OVS2). (SV031: + direction, SV042: - direction. However, the directions may be opposite depending on other settings.)  
 When "-1" is set, the compensation will not be performed in the direction of the command.

Related parameters: SV027/bitB,A, SV034/bitF-C, SV042, SV082/bit2

**---Setting range---**

-1 to 100 (Stall current %)

Note that the range will be "-1 - 10000" (Stall current 0.01%) when SV082/bit2 is "1".

#2232	SV032 TOF	Torque offset
		<p>Set the unbalance torque on vertical axis and inclined axis.</p> <p>When the vertical axis pull up function is enabled, the pull up compensation direction is determined by this parameter's sign. When set to "0", and the pull up function is enabled (SV033/bitE=1), the alarm "S02 2233 Initial parameter error" occurs.</p> <p>This can be used for speed loop delay compensation and collision detection function.</p> <p>To use load inertia estimation function (drive monitor display), set this parameter, friction torque (SV045) and load inertia display enabling flag(SV035/bitF).</p> <p>Related parameters: SV007, SV033/bitE, SV059</p> <p><b>---Setting range---</b></p> <p>-100 to 100 (Stall current %)</p>

<b>#2233</b>	<b>SV033 SSF2</b>	<b>Servo function 2</b>
--------------	-------------------	-------------------------

Select the servo functions.  
 A function is assigned to each bit.  
 Set this in hexadecimal format.

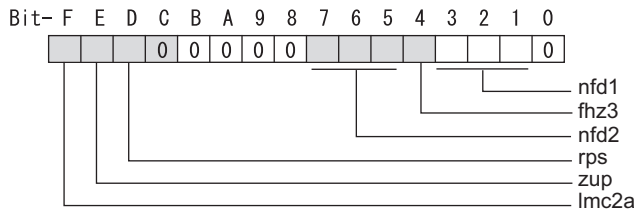

**bit F : lmc2a Lost motion compensation 2 timing**

0: Normal 1: Change

**bit E : zup Vertical axis pull up function**

0: Stop 1: Enable

Related parameters: SV032, SV095

**bit D : rps Safely limited speed setting increment**

Change the setting units of the specified speed signal output speed (SV073).

0: mm/min 1: 100mm/min

Related parameters: SV073

**bit C-8 :**

Not used. Set to "0".

**bit 7-5 : nfd2 Depth of Notch filter 2**

Set the depth of Notch filter 2 (SV046).

- bit7,6,5=
- 000: -∞
- 001: -18.1[dB]
- 010: -12.0[dB]
- 011: -8.5[dB]
- 100: -6.0[dB]
- 101: -4.1[dB]
- 110: -2.5[dB]
- 111: -1.2[dB]

**bit 4 : fhz3 Notch filter 3**

0: Stop 1: Start (1125Hz)

**bit 3-1 : nfd1 Depth of Notch filter 1**

Set the depth of Notch filter 1 (SV038).

- bit3,2,1=
- 000: -∞
- 001: -18.1[dB]
- 010: -12.0[dB]
- 011: -8.5[dB]
- 100: -6.0[dB]
- 101: -4.1[dB]
- 110: -2.5[dB]
- 111: -1.2[dB]

**bit 0 :**

Not used. Set to "0".

<b>#2234</b>	<b>SV034 SSF3</b>	<b>Servo function 3</b>
--------------	-------------------	-------------------------

Select the servo functions.  
 A function is assigned to each bit.  
 Set this in hexadecimal format.

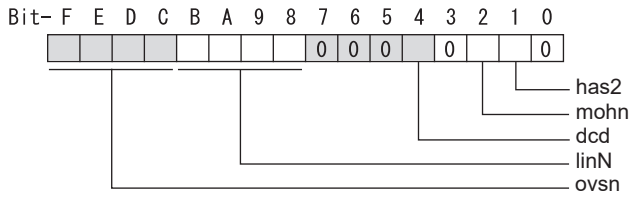

**bit F-C: ovsn Overshooting compensation type 3 Non-sensitive band**

Set the non-sensitive band of the model position droop overshooting amount in increments of 2µm.  
 In the feed forward control, set the non-sensitive band of the model position droop and ignore the overshooting of the model.  
 0 : 0 µm, 1: 2 µm, 2: 4µm,---, E : 28 µm, F: 30µm

**bit B-8 : linN The number of parallel connections when using linear motors (for linear)**

Set to "2" to perform 1 amplifier 2 motor control by linear servo.

**bit 7-5 :**

Not used. Set to "0".

**bit 4 : dcd (linear/direct-drive motor)**

0: Normal setting    1: DC excitation mode

Related parameters: SV061, SV062, SV063

**bit 3 :**

Not used. Set to "0".

**bit 2 : mohn Thermistor temperature detection (linear/direct-drive motor)**

0: Normal setting    1: Disable

**bit 1 : has HAS control**

This stabilizes the speed overshooting by torque saturation phenomenon.  
 0: Normal setting    1: Enable

Related parameters: SV084/bitF

**bit 0 :**

Not used. Set to "0".

---

#2235      SV035 SSF4      Servo function 4

---

Select the servo functions.  
 A function is assigned to each bit.  
 Set this in hexadecimal format.

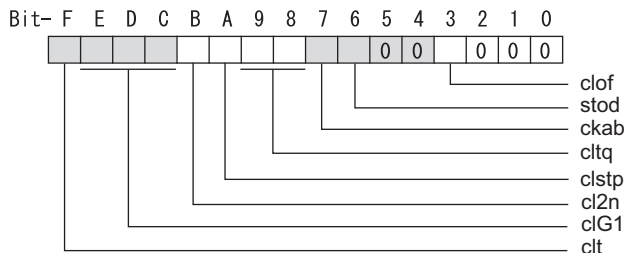

**bit F: clt Inertia ratio display**

- 0: Setting for normal use
- 1: Display the total inertia ratio estimated at acceleration/deceleration at the inertia ratio on the servo monitor screen  
 To display it on the screen, set an imbalance torque and friction torque to both SV032 and SV045 and repeat acceleration/deceleration operations for several times.

**bit E-C: clG1 G1 Collision detection level**

Set the collision detection level in the collision detection method 1 during cutting feed (G1) in multiples of that of rapid traverse (G0). When set to "0", detection of collision detection method 1 during cutting feed will be ignored.  
 $G1 \text{ Collision detection level} = G0 \text{ collision detection level (SV060)} \times clG1$

**bit B: cl2n Collision detection method 2**

- 0: Enable    1: Disable

**bit A: clstp Collision detection method 1 disabled during stop**

- 0: Collision detection method 1 enabled during stop
- 1: Collision detection method 1 disabled during stop

**bit 9-8: cltq Retract torque in collision detection**

Set the retract torque in collision detection using the ratio of motor's maximum torque.  
 bit9,8=  
 00: 100%  
 01: 90%  
 10: 80% (Standard)  
 11: 70%

**bit 7: ckab No signal detection 2**

Set this to use rectangular wave output linear scale.  
 This enables the detection of No signal 2 (alarm 21).  
 0: Disable    1: Enable

**bit 6: stod Alarm 4D-2 detection disabled during deceleration and stop**

- 0: Normal    1: Alarm 4D-2 detection disabled during deceleration and stop

**bit 5-4:**

Not used. Set to "0".

**bit 3: clof Collision detection estimated disturbance torque offset**

- 0: Disable    1: Enable

**bit 2-0:**

Not used. Set to "0".



(PR)	#2236	SV036 P TYP	Power supply type/ Regenerative resistor type
------	-------	-------------	---

**MDS-E/EH Series: Power supply type**

When connecting a power supply unit, set a code for each power supply unit.

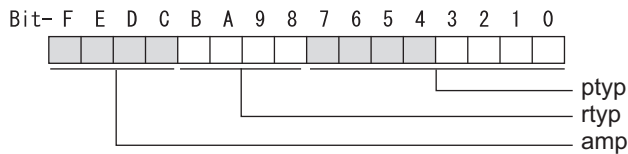

**bit F-C : amp**

Set the power backup function to be used.

- No function used : 0
- Deceleration and stop function at power failure : 8
- Retraction function at power failure : C

**bit B-8 : rtp**

Not used. Set to "0".

**bit 7-0 : ptyp External emergency stop setting**

When the emergency stop input signal of the power supply unit is "disabled"

- Power supply unit is not connected : 00
- MDS-E-CV-37 / MDS-EH-CV-37 : 04
- MDS-E-CV-75 / MDS-EH-CV-75 : 08
- MDS-E-CV-110 / MDS-EH-CV-110 : 11
- MDS-E-CV-185 / MDS-EH-CV-185 : 19
- MDS-E-CV-300 / MDS-EH-CV-300 : 30
- MDS-E-CV-370 / MDS-EH-CV-370 : 37
- MDS-E-CV-450 / MDS-EH-CV-450 : 45
- MDS-E-CV-550 / MDS-EH-CV-550 : 55
- MDS-EH-CV-750 : 75

When the emergency stop input signal of the power supply unit is "enabled"

(Note) Set the power supply rotary switch to "4".

- Power supply unit is not connected : 00
- MDS-E-CV-37 / MDS-EH-CV-37 : 44
- MDS-E-CV-75 / MDS-EH-CV-75 : 48
- MDS-E-CV-110 / MDS-EH-CV-110 : 51
- MDS-E-CV-185 / MDS-EH-CV-185 : 59
- MDS-E-CV-300 / MDS-EH-CV-300 : 70
- MDS-E-CV-370 / MDS-EH-CV-370 : 77
- MDS-E-CV-450 / MDS-EH-CV-450 : 85
- MDS-E-CV-550 / MDS-EH-CV-550 : 95
- MDS-EH-CV-750 : B5

**MDS-EM/EMH Series**

Not used. Set to "0000".

External emergency stop power supply type is set by spindle parameter (SP032).

**MDS-EJ/EJH Series: Regenerative resistor type**

Set the regenerative resistor type.

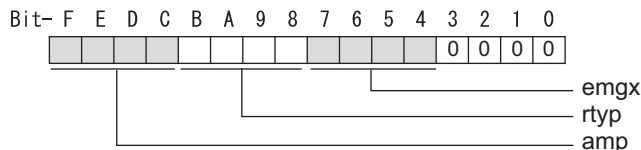

**bit F-8 : amp(bit F-C) / rtyp(bit B-8)**

- Resistor built-in drive unit : 10
- Setting prohibited : 11
- MR-RB032 : 12
- MR-RB12 or GZG200W39OHMK : 13
- MR-RB32 or GZG200W120OHMK 3 units connected in parallel : 14
- MR-RB30 or GZG200W39OHMK 3 units connected in parallel : 15
- MR-RB50 or GZG300W39OHMK 3 units connected in parallel : 16
- MR-RB31 or GZG200W20OHMK 3 units connected in parallel : 17
- MR-RB51 or GZG300W20OHMK 3 units connected in parallel : 18
- Setting prohibited : 19-1F
  
- Setting prohibited : 20-23
- FCUA-RB22 : 24
- FCUA-RB37 : 25
- FCUA-RB55 : 26
- FCUA-RB75/2 : 27
- Setting prohibited : 28
- R-UNIT2 : 29
- Setting prohibited : 2A-2C
- FCUA-RB75/2 2 units connected in parallel : 2D
- FCUA-RB55 2 units connected in parallel : 2E
- Setting prohibited : 2F
  
- MR-RB1H-4 : 33
- MR-RB3M-4 : 34
- MR-RB3G-4 : 35
- MR-RB5G-4 : 36

**bit 7-4 : emgx External emergency stop function**

Set the external emergency stop function.  
0: Disable 4: Enable

**bit 3-0 :**

Not used. Set to "0".

#2237	SV037 JL	Load inertia scale
	Set the motor axis conversion total load inertia including motor itself in proportion to the motor inertia. $SV037(JL) = (J_m + J_l) / J_m \times 100$ J <sub>m</sub> : Motor inertia J <sub>l</sub> : Motor axis conversion load inertia	
	For linear motor, set the gross mass of the moving sections in kg unit.	
	<<Drive monitor load inertia ratio display>> Set SV035/bitF=1 and imbalance torque and friction torque to both SV032 and SV045, and then repeat acceleration/deceleration for several times.	
	---Setting range---	
	For general motor: 0 to 5000 (%) For linear motor 0 to 5000 (kg)	

<b>#2238</b>	<b>SV038 FHz1</b>	<b>Notch filter frequency 1</b>
<p>Set the vibration frequency to suppress when machine vibration occurs. (Normally, do not set 80 or less.) Set to "0" when not using.</p> <p>Related parameters: SV033/bit3-1, SV115</p> <p>---Setting range--- 0 to 5000 (Hz)</p>		
<b>#2239</b>	<b>SV039 LMCD</b>	<b>Lost motion compensation timing</b>
<p>Set this when the timing of lost motion compensation type 2 does not match. Adjust increments of 10 at a time.</p> <p>---Setting range--- 0 to 2000 (ms)</p>		
<b>#2240</b>	<b>SV040 LMCT</b>	<b>Lost motion compensation non-sensitive band</b>
<p>Set the non-sensitive band of the lost motion compensation in the feed forward control. When "0" is set, 2<math>\mu</math>m is the actual value to be set. Adjust increments of 1<math>\mu</math>m.</p> <p>---Setting range--- 0 to 255 (<math>\mu</math>m)</p>		
<b>#2241</b>	<b>SV041 LMC2</b>	<b>Lost motion compensation 2</b>
<p>Set this with SV016 (LMC1) only when you wish to vary the lost motion compensation amount depending on the command directions. Normally, set to "0".</p> <p>---Setting range--- -1 to 200 (Stall current %) Note that when SV082/bit2 is "1", the setting range is between -1 and 20000 (Stall current 0.01%).</p>		
<b>#2242</b>	<b>SV042 OVS2</b>	<b>Overshooting compensation 2</b>
<p>Set this with SV031 (OVS1) only when you wish to vary the overshooting compensation amount depending on the command directions. Normally, set to "0".</p> <p>---Setting range--- -1 to 100 (Stall current %) Note that when SV082/bit2 is "1", the setting range is between -1 and 10000 (Stall current 0.01%).</p>		
<b>#2243</b>	<b>SV043 OBS1</b>	<b>Disturbance observer filter frequency</b>
<p>Set the disturbance observer filter band. Normally, set to "100". Setting values of 49 or less is equal to "0" setting. To use the disturbance observer, also set SV037 (JL) and SV044 (OBS2). When disturbance observer related parameters are changed, lost motion compensation needs to be readjusted. Set to "0" when not using.</p> <p>---Setting range--- 0 to 1000 (rad/s)</p>		
<b>#2244</b>	<b>SV044 OBS2</b>	<b>Disturbance observer gain</b>
<p>Set the disturbance observer gain. The standard setting is "100 to 300". To use the disturbance observer, also set SV037 (JL) and SV043 (OBS1). When disturbance observer related parameters are changed, lost motion compensation needs to be readjusted. Set to "0" when not using.</p> <p>---Setting range--- 0 to 500 (%)</p>		
<b>#2245</b>	<b>SV045 TRUB</b>	<b>Friction torque</b>
<p>Set the frictional torque when using the collision detection function. To use load inertia estimation function (drive monitor display), set this parameter, imbalance torque (SV032) and load inertia display enabling flag (SV035/bitF).</p> <p>---Setting range--- 0 to 255 (Stall current %)</p>		

<b>#2246</b>	<b>SV046 FHz2</b>	<b>Notch filter frequency 2</b>
<p>Set the vibration frequency to suppress when machine vibration occurs. (Normally, do not set 80 or less.) Set to "0" when not using.</p> <p>Related parameters: SV033/bit7-5, SV115</p> <p><b>---Setting range---</b> 0 to 5000 (Hz)</p>		
<b>#2247</b>	<b>SV047 EC</b>	<b>Inductive voltage compensation gain</b>
<p>Set the inductive voltage compensation gain. Standard setting value is "100". If the current FB peak exceeds the current command peak, lower the gain.</p> <p><b>---Setting range---</b> 0 to 200 (%)</p>		
<b>#2248</b>	<b>SV048 EMGrT</b>	<b>Vertical axis drop prevention time</b>
<p>Input the time required to prevent the vertical axis from dropping by delaying READY OFF until the brake works at an emergency stop. Increase in increments of 100ms at a time, find and set the value where the axis does not drop. When using a motor with a break of HG(-H) Series and HQ-H Series, set to "200ms" as a standard. When the pull up function is enabled (SV033/bitE=1), the pull up is established during the drop prevention time.</p> <p>(Note) When not using the spindle drive unit, use the servo axis that controls vertical axis drop prevention control to control the power supply (connect with CN4).</p> <p>Related parameters: SV033/bitE, SV055, SV056</p> <p><b>---Setting range---</b> 0 to 20000 (ms) When set to "0", and the pull up function is enabled (SV033/bitE=1), the alarm "S02 2233 Initial parameter error" occurs.</p>		
<b>#2249</b>	<b>SV049 PGN1sp</b>	<b>Position loop gain 1 in spindle synchronous control</b>
<p>Set the position loop gain during spindle synchronization control (synchronous tapping and synchronization control with spindle C-axis). Set the same value as that of the position loop gain for spindle synchronous tapping control. When performing the SHG control, set this parameter with SV050 (PGN2sp) and SV058 (SHGCsp). When changing the value, change the value of "#2017 tap_g Axis servo gain".</p> <p><b>---Setting range---</b> 1 to 200 (rad/s)</p>		
<b>#2250</b>	<b>SV050 PGN2sp</b>	<b>Position loop gain 2 in spindle synchronous control</b>
<p>When using SHG control during spindle synchronous control (synchronous tapping and synchronization control with spindle C-axis), set this parameter with SV049 (PGN1sp) and SV058 (SHGCsp). Make sure to set the value 8/3 times that of SV049. When not using the SHG control, set to "0".</p> <p><b>---Setting range---</b> 0 to 999 (rad/s)</p>		
<b>#2251</b>	<b>SV051 DFBT</b>	<b>Dual feedback control time constant</b>
<p>Set the control time constant in dual feed back. When "0" is set, it operates at 1ms. The higher the time constant is, the closer it gets to the semi-closed control, so the limit of the position loop gain will be raised.</p> <p>For linear servo/direct-drive motor system Not used. Set to "0".</p> <p>Related parameters: SV017/bit1, SV052</p> <p><b>---Setting range---</b> 0 to 9999 (ms)</p>		

<b>#2252</b>	<b>SV052 DFBN</b>	<b>Dual feedback control non-sensitive band</b>
<p>Set the non-sensitive band in the dual feedback control. Normally, set to "0".</p> <p>For linear servo/direct-drive motor system Not used. Set to "0".</p> <p>Related parameters: SV017/bit1, SV052</p> <p><b>---Setting range---</b> 0 to 9999 (<math>\mu\text{m}</math>)</p>		
<b>#2253</b>	<b>SV053 OD3</b>	<b>Excessive error detection width in special control</b>
<p>Set the excessive error detection width when servo ON in a special control (initial absolute position setting, stopper control and etc.). When "0" is set, excessive error detection will not be performed when servo ON during a special control.</p> <p><b>---Setting range---</b> 0 to 32767 (mm) However, when SV084/bitC=1, the setting range is from 0 to 32767 (<math>\mu\text{m}</math>).</p>		
<b>#2254</b>	<b>SV054 ORE</b>	<b>Overrun detection width in closed loop control</b>
<p>Set the overrun detection width in the full-closed loop control. When the gap between the motor side encoder and the linear scale (machine side encoder) exceeds the value set by this parameter, it will be judged as overrun and "Alarm 43" will be detected. When "-1" is set, if the differential velocity between the motor side encoder and the machine side encoder exceeds the 30% of the maximum motor speed, it will be judged as overrun and "Alarm 43" will be detected. When "0" is set, overrun will be detected with a 2mm width.</p> <p>For linear servo/direct-drive motor system Not used. Set to "0".</p> <p><b>---Setting range---</b> -1 to 32767 (mm) However, when SV084/bitD=1, the setting range is from -1 to 32767 (<math>\mu\text{m}</math>).</p>		
<b>#2255</b>	<b>SV055 EMGx</b>	<b>Max. gate off delay time after emergency stop</b>
<p>Set the time required between an emergency stop and forced READY OFF. Set the maximum value "+ 100ms" of the SV056 setting value of the servo drive unit electrified by the same power supply unit. When executing the vertical axis drop prevention, the gate off will be delayed for the length of time set at SV048 even when SV055's is smaller than that of SV048.</p> <p>Related parameters: SV048, SV056</p> <p><b>---Setting range---</b> 0 to 20000 (ms)</p>		
<b>#2256</b>	<b>SV056 EMGt</b>	<b>Deceleration time constant at emergency stop</b>
<p>Set the time constant used for the deceleration control at emergency stop. Set the time required to stop from rapid traverse rate (rapid). The standard setting value is <math>\text{EMGt} \leq \text{G0tL} \times 0.9</math>. However, note that the standard setting value differs from the above-mentioned value when the setting value of "#2003:smgst Acceleration and deceleration modes bit 3-0:Rapid traverse acceleration/deceleration type" is 8 or F. Refer to Instruction Manual of the drive unit (section "5.5.1 Deceleration Control") for details.</p> <p>Related parameters: SV048, SV055</p> <p><b>---Setting range---</b> 0 to 20000 (ms)</p>		
<b>#2257</b>	<b>SV057 SHGC</b>	<b>SHG control gain</b>
<p>When performing the SHG control, set to <math>\text{SV003}(\text{PGN1}) \times 6</math>. When not using the SHG control, set to "0". When using the OMR-FF control, set to "0".</p> <p>Related parameters: SV003, SV004</p> <p><b>---Setting range---</b> 0 to 1200 (rad/s)</p>		

#2258	SV058 SHGCsp	SHG control gain in spindle synchronous control
		<p>When using SHG control during spindle synchronization control (synchronous tapping and synchronous control with spindle C-axis), set this parameter with SV049 (PGN1sp) and SV050 (PGN2sp). Make sure to set the value 6 times that of SV049. When not using the SHG control, set to "0".</p> <p><b>---Setting range---</b></p> <p>0 to 1200 (rad/s)</p>
#2259	SV059 TCNV	Collision detection torque estimated gain
		<p>Set the torque estimated gain when using the collision detection function. The standard setting value is the same as the load inertia ratio (SV037 setting value) including motor inertia. Set to "0" when not using the collision detection function.</p> <p>Related parameters: SV032, SV035/bitF-8, SV037, SV045, SV060</p> <p>&lt;&lt;Drive monitor load inertia ratio display&gt;&gt; Set SV035/bitF=1 and imbalance torque and friction torque to both SV032 and SV045, and then repeat acceleration/deceleration for several times.</p> <p><b>---Setting range---</b></p> <p>For general motor: 0 to 5000 (%) For linear motor: 0 to 5000 (kg)</p>
#2260	SV060 TLMT	Collision detection level
		<p>When using the collision detection function, set the collision detection level at the G0 feeding. When "0" is set, none of the collision detection function will work.</p> <p>Related parameters: SV032, SV035/bitF-8, SV037, SV045, SV059</p> <p><b>---Setting range---</b></p> <p>0 to 999 (Stall current %)</p>
#2261	SV061 DA1NO	D/A output ch1 data No. / Initial DC excitation level
		<p>Input the data number you wish to output to the D/A output channel 1. When using the 2-axis drive unit, set "-1" to the axis that the data will not be output.</p> <p>When the DC excitation is running (SV034/bit4=1): Use this when the DC excitation is running (SV034/bit4=1) to adjust the initial magnetic pole position (when measuring the magnetic pole shift amount) for linear motor and direct-drive motor. Set the initial excitation level in DC excitation control. Set 10% as standard. Related parameters: SV062, SV063</p> <p><b>---Setting range---</b></p> <p>-32768 to 32767 When the DC excitation is running (SV034/bit4=1): 0 to 100 (Stall current %)</p>
#2262	SV062 DA2NO	D/A output ch2 data No. / Final DC excitation level
		<p>Input the data number you wish to output to the D/A output channel 2. When using the 2-axis drive unit, set "-1" to the axis that the data will not be output.</p> <p>When the DC excitation is running (SV034/bit4=1): Use this when the DC excitation is running (SV034/bit4=1) to adjust the initial magnetic pole position (when measuring the magnetic pole shift amount) for linear motor and direct-drive motor. Set the final excitation level in DC excitation control. Set 10% as standard. When the magnetic pole shift amount measurement value is unsteady, adjust the value in increments of 5%. Related parameters: SV061, SV063</p> <p><b>---Setting range---</b></p> <p>-32768 to 32767 When the DC excitation is running (SV034/bit4=1): 0 to 100 (Stall current %)</p>

#2263	SV063 DA1MPY	D/A output ch1 output scale / Initial DC excitation time
<p>Set output scale of the D/A output channel 1 in increment of 1/100. When "0" is set, the magnification is the same as when "100" is set.</p> <p>When the DC excitation is running (SV034/bit4=1): Use this when the DC excitation is running (SV034/bit4=1) to adjust the initial magnetic pole position (when measuring the magnetic pole shift amount) for linear motor and direct-drive motor. Set the initial excitation time in DC excitation control. Set 1000ms as standard. When the magnetic pole shift amount measurement value is unsteady, adjust the value in increments of 500ms. Related parameters: SV061, SV062</p> <p>---Setting range--- -32768 to 32767 (1/100-fold) When the DC excitation is running (SV034/bit4=1): 0 to 10000 (ms)</p>		
#2264	SV064 DA2MPY	D/A output ch2 output scale
<p>Set output scale of the D/A output channel 2 in increment of 1/100. When "0" is set, the magnification is the same as when "100" is set.</p> <p>---Setting range--- -32768 to 32767 (1/100-fold)</p>		
#2265	SV065 TLC	Machine end compensation gain
<p>The shape of the machine end is compensated by compensating the spring effect from the machine end to the motor end. Set the machine end compensation gain. Measure the error amount by roundness measurement and estimate the setting value by the following formula.</p> <p>Compensation amount (μm) = Command speed F(mm/min)<sup>2</sup> * SV065 / (Radius R(mm) * SV003 * 16,200,000)</p> <p>Set to "0" when not using.</p> <p>---Setting range--- -30000 to 30000 (Acceleration ratio 0.1%)</p>		
#2266-2272	SV066 - SV072	
<p>This parameter is set automatically by the NC system.</p>		
(PR)	#2273	SV073 FEEDout Specified speed output speed
<p>Set the specified speed. Also set SV082/bit9,8 to output digital signal.</p> <p>---Setting range--- 0 to 32767 (mm/min) However, when SV033/bitD=1, the setting range is from 0 to 32767 (100mm/min). (Only for MDS-E/EH and MDS-EM/EMH)</p>		
#2274-2280	SV074 - SV080	
<p>This parameter is set automatically by the NC system.</p>		

<b>(PR)</b>	<b>#2281</b>	<b>SV081 SPEC2</b>	<b>Servo specification 2</b>
-------------	--------------	--------------------	------------------------------

Select the servo functions.  
 A function is assigned to each bit.  
 Set this in hexadecimal format.

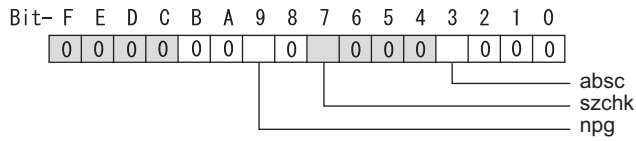

**bit F-A:**

Not used. Set to "0".

**bit 9: npg Earth fault detection**

0: Disable 1: Enable (standard)

Set "0" and it is constantly "Enable" for MDS-EJ/EJH Series.

**bit 8:**

Not used. Set to "0".

**bit 7: szchk Distance-coded reference scale reference mark**

0: Check at 4 points (standard) 1: Check at 3 points

**bit 6-4:**

Not used. Set to "0".

**bit 3: absc Distance-coded reference scale**

0: Disable 1: Enable

**bit 2-0:**

Not used. Set to "0".



<b>#2282</b>	<b>SV082 SSF5</b>	<b>Servo function 5</b>
--------------	-------------------	-------------------------

Select the servo functions.  
 A function is assigned to each bit.  
 Set this in hexadecimal format.

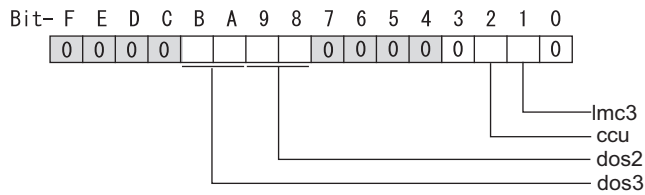

**bit F-C:**

Not used. Set to "0".

**bit B-A: dos3 Digital signal output 3 selection**

- bitB,A=  
 00: Disable  
 01: Setting prohibited  
 10: Contactor control signal output (For MDS-EJ/EJH)  
 11: Setting prohibited

**bit 9-8: dos2 Digital signal output 2 selection**

- bit9,8=  
 00: Disable  
 01: Specified speed output  
 10: Setting prohibited  
 11: Setting prohibited

**bit 7-3:**

Not used. Set to "0".

**bit 2: ccu Lost motion overshoot compensation compensation amount setting increment**

- 0: Stall current %    1: Stall current 0.01%

**bit 1: lmc3 Lost motion compensation type 3**

Set this when protrusion at a quadrant change is too big.  
 0: Stop    1: Start

Related parameters: SV016, SV041, SV085, SV086

**bit 0:**

Not used. Set to "0".

---

#2283	SV083 SSF6	Servo function 6
-------	------------	------------------

---

Select the servo functions.  
 A function is assigned to each bit.  
 Set this in hexadecimal format.

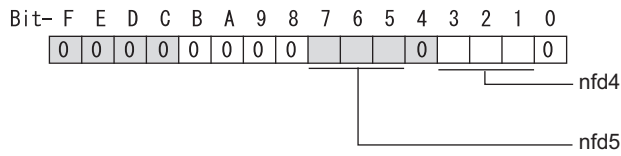

**bit F-8 :**

Not used. Set to "0".

**bit 7-5 : nfd5 Depth of Notch filter 5**

Set the depth of Notch filter 5 (SV088).

- bit7,6,5=  
 000: -∞  
 001: -18.1[dB]  
 010: -12.0[dB]  
 011: -8.5[dB]  
 100: -6.0[dB]  
 101: -4.1[dB]  
 110: -2.5[dB]  
 111: -1.2[dB]

**bit 4 :**

Not used. Set to "0".

**bit 3-1 : nfd4 Depth of Notch filter 4**

Set the depth of Notch filter 4 (SV087).

- bit3,2,1=  
 000: -∞  
 001: -18.1[dB]  
 010: -12.0[dB]  
 011: -8.5[dB]  
 100: -6.0[dB]  
 101: -4.1[dB]  
 110: -2.5[dB]  
 111: -1.2[dB]

**bit 0 :**

Not used. Set to "0".

<b>#2284</b>	<b>SV084 SSF7</b>	<b>Servo function 7</b>
--------------	-------------------	-------------------------

Select the servo functions.  
 A function is assigned to each bit.  
 Set this in hexadecimal format.

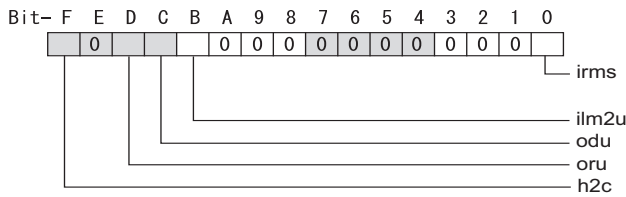

**bit F : h2c HAS control cancel amount**

0: 1/4 (standard)    1: 1/2

Related parameters: SV034/bit1

**bit E :**

Not used. Set to "0".

**bit D : oru Overrun detection width unit**

0: mm (normal setting)    1: μm

**bit C : odu Excessive error detection width unit**

0: mm (normal setting)    1: μm

**bit B : ilm2u Current limit value (SV014) in special control setting unit**

0: Stall current % (normal setting)    1: Stall current 0.01%

**bit A-1 :**

Not used. Set to "0".

**bit 0 : irms Motor current display**

0: Motor q axis current display (normal)    1: Motor effective current display

<b>#2285</b>	<b>SV085 LMck</b>	<b>Lost motion compensation 3 spring constant</b>
--------------	-------------------	---

Set the machine system's spring constant when selecting lost motion compensation type 3.  
 When not using, set to "0".

Related parameters: SV016, SV041, SV082/bit2,1, SV086

**---Setting range---**

0 to 32767 (0.01%/μm)

<b>#2286</b>	<b>SV086 LMcc</b>	<b>Lost motion compensation 3 viscous coefficient</b>
--------------	-------------------	---

Set the machine system's viscous coefficient when selecting lost motion compensation type 3.  
 When not using, set to "0".

Related parameters: SV016, SV041, SV082/bit2,1, SV086

**---Setting range---**

0 to 32767 (0.01%\*s/mm)

<b>#2287</b>	<b>SV087 FHz4</b>	<b>Notch filter frequency 4</b>
--------------	-------------------	---------------------------------

Set the vibration frequency to suppress when machine vibration occurs.  
 (Normally, do not set 80 or less.)  
 Set to "0" when not using.

Related parameters: SV083/bit3-1, SV115

**---Setting range---**

0 to 5000 (Hz)

<b>#2288</b>	<b>SV088 FHz5</b>	<b>Notch filter frequency 5</b>
<p>Set the vibration frequency to suppress when machine vibration occurs. (Normally, do not set 80 or less.) Set to "0" when not using.</p> <p>Related parameters: SV083/bit7-5, SV115</p> <p><b>---Setting range---</b> 0 to 5000 (Hz)</p>		
<b>#2289</b>	<b>SV089</b>	
Not used. Set to "0".		
<b>#2290</b>	<b>SV090</b>	
Not used. Set to "0".		
<b>#2291</b>	<b>SV091 LMC4G</b>	<b>Lost motion compensation 4 gain</b>
<p>Use this with LMC compensation type 3. As the delay in path tracking is monitored and compensated, the delay in path tracking will be minimized even if machine friction amount changes by aging. Use the lost motion compensation amount (SV016) * 5 (10% of the dynamic friction torque) as the target. The higher the setting value is, the more accurate the quadrant change be; however, the more likely vibrations occur.</p> <p><b>---Setting range---</b> 0 to 20000 (Stall current 0.01%)</p>		
<b>#2292</b>	<b>SV092</b>	
Not used. Set to "0".		
<b>#2293</b>	<b>SV093</b>	
Not used. Set to "0".		
<b>#2294</b>	<b>SV094 MPV</b>	<b>Magnetic pole position error detection speed</b>
<p>The magnetic pole position detection function monitors the command speed and motor speed at the position command stop and detects the magnetic pole position error alarm (3E) if any. Set the error detection level for the command speed and motor speed at the position command stop. Be aware when setting the parameter as the setting units for general motors and linear motors are different.</p> <p>&lt;&lt;For general motor&gt;&gt; When the command speed error detection level is set to "0", the magnetic pole position error (3E) is detected at 10r/min. Set "10" as standard. This detects the magnetic pole position error (3E) when the motor rotation speed is 100r/min and more.</p> <p>&lt;&lt;For linear motor&gt;&gt; When the command motor speed level is set to "0", the magnetic pole position error (3E) is detected at 1mm/s. Set "10" as standard. This detects the magnetic pole position error (3E) when the motor speed is 10mm/s and more.</p> <p><b>---Setting range---</b> 0 to 31999</p> <p>&lt;&lt;For general motor&gt;&gt; Ten-thousands digit, Thousands digit ----- Command speed error detection level (10r/min) Hundreds digit, Tens digit, Ones digit ----- Motor speed error detection level (10r/min)</p> <p>&lt;&lt;For linear motor&gt;&gt; Ten-thousands digit, Thousands digit ----- Command speed error detection speed level (1mm/s) Hundreds digit, Tens digit, Ones digit ----- Motor speed error detection level (1mm/s)</p>		

#2295	SV095 ZUPD	Vertical axis pull up distance
<p>Set this parameter to adjust the pull up distance when the vertical axis pull up function is enabled. When the pull up function is enabled and this parameter is set to "0", for a rotary motor, 8/1000 of a rotation at the motor end is internally set as the pull up distance, and for a linear motor, 80[μm] is set.</p> <p>Related parameters:                  SV032 : The pull up direction is determined. When "0" is set, the alarm occurs.                  SV033/bitE : Start-up of the pull up function                  SV048 : Set the drop prevention time. When "0" is set, the alarm occurs.</p> <p>---Setting range---                  0 to 2000 (μm)</p>		
#2296-2305	SV096 - SV105	
<p>Not used. Set to "0".</p>		
#2306	SV106 PGM	OMR-FF scale model gain
<p>Set the scale model gain (position response) in OMR-FF control.                  Set the same value as SV003(PGN1).                  Increase the setting value to perform a high-speed machining such as a fine arc or to improve the path error. Lower the value when vibration occurs during acceleration/deceleration.                  Set to "0" when not using OMR-FF control.</p> <p>---Setting range---                  0 to 300 (rad/s)</p>		
#2307-2311	SV107 - SV111	
<p>Not used. Set to "0".</p>		
#2312	SV112 IFF	OMR-FF current feed forward gain
<p>Set the current feed forward rate in OMR-FF control.                  The standard setting is "10000".                  Setting value of "0" is equal to "10000(100%)" setting.                  Set to "0" when not using OMR-FF control.</p> <p>---Setting range---                  0 to 32767 (0.01%)</p>		
#2313	SV113 SSF8	Servo function 8

Select the servo functions.  
 A function is assigned to each bit.  
 Set this in hexadecimal format.

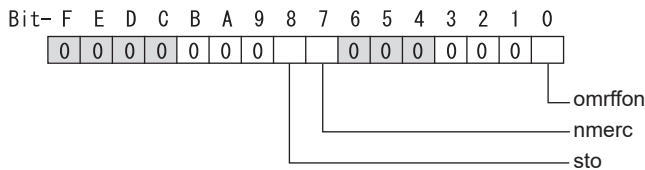

**bit F-9 :**

Not used. Set to "0".

**bit 8 : sto Dedicated wiring STO function**

Set this parameter to use dedicated wiring STO function.  
 0: Dedicated wiring STO function unused    1: Dedicated wiring STO function used  
 (Only for MDS-E/EH and MDS-EJ/EJH)

**bit 7 : nmerc Machine error compensation amount**

(Note) Do not turn ON the NC power supply with the setting as disable (set to "1"). The initial parameter error alarm is detected.

0: Enable (Normal setting)    1: Disable

**bit 0 : omrffon OMR-FF control enabled**

0: Disable    1: Enable

---

<b>#2314</b>	<b>SV114 SSF9</b>	<b>Servo function 9</b>
--------------	-------------------	-------------------------

---

Select the servo functions.  
 A function is assigned to each bit.  
 Set this in hexadecimal format.

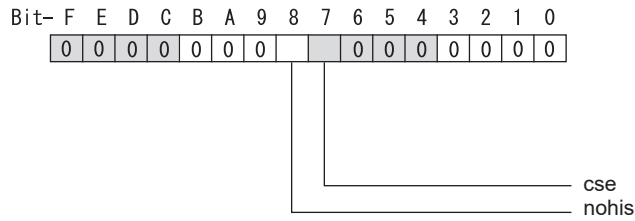

**bit F-9 :**

Set to "8" when HG46, 56, 96 motors are driven by MDS-E-V3.  
 Set to "0" for other cases.

**bit 8 : nohis History of communication error alarm between NC and DRV (34, 36, 38, 39)**

0: Enable    1: Disable

**bit 7 : cse Command speed monitoring function**

0: Disable    1: Enable (Normal setting)

**bit 6-0 :**

Not used. Set to "0".

<b>#2315</b>	<b>SV115 SSF10</b>	<b>Servo function 10</b>
--------------	--------------------	--------------------------

Select the servo functions.  
 A function is assigned to each bit.  
 Set this in hexadecimal format.

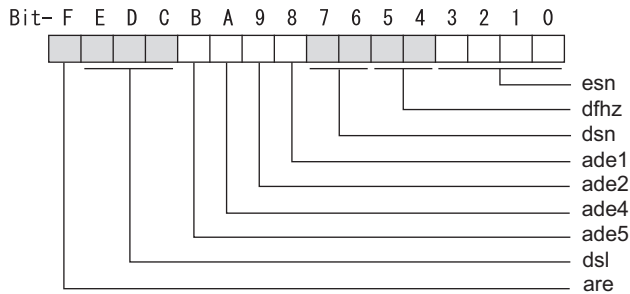

**bit F : are Notch filter5 all frequencies adapted**

When enabled, Notch filter5 all frequencies adaptive range is not limited regardless of SV115/bit4,5 setting.  
 0: Disable 1: Enable

**bit E-C: dsl Notch filter frequency display**

Switch the "AFLT frequency" display on drive monitor screen to check every notch filter frequency.  
 When the selected notch filter is not used, "0" is displayed.

- bitE,D,C=  
 000 : Estimated resonance frequency (Normal display)  
 001 : Notch filter 1 frequency  
 010 : Notch filter 2 frequency  
 011 : Notch filter 3 frequency (always displays 1125Hz)  
 100 : Notch filter 4 frequency  
 101 : Notch filter 5 frequency  
 Other settings: setting prohibited

**bit B : ade5 Notch filter 5 / Adaptive follow-up function**

0: Disable 1: Enable

**bit A : ade4 Notch filter 4 / Adaptive follow-up function**

0: Disable 1: Enable

**bit 9 : ade2 Notch filter 2 / Adaptive follow-up function**

0: Disable 1: Enable

**bit 8 : ade1 Notch filter 1 / Adaptive follow-up function**

0: Disable 1: Enable

**bit 7-6 : dsn Estimated resonance frequency display holding time**

Set the estimated resonance frequency display holding time to the "AFLT frequency" display on drive monitor screen.

- bit7,6=  
 00: 4 [s]  
 01: 8 [s]  
 10: 12 [s]  
 11: 16 [s]

**bit 5-4 : dfhz Notch filter frequency range**

Set the adaptive range of the notch filter frequency. When the adaptive follow-up function is enabled and if the estimated resonance frequency exists in the set range, the notch filter will be adapted. Normally set this parameter to "00".

- bit5,4=  
 00: -10 to 10 [%]  
 01: -20 to 20 [%]  
 10: -30 to 30 [%]  
 11: -40 to 40 [%]

**bit 3-0 : esn Sensitivity of estimated resonance frequency**

Set the sensitivity of the estimated resonance frequency. When the notch filter adaptive follow-up function is enabled, smaller setting value enables to detect smaller vibration component, however, adaptive movement will be repeated frequently. Normally set this parameter to "0".

0 : Normal setting (same sensitivity as A) 1 : Sensitivity high to F : Sensitivity low

---

**#2316 SV116 SSF11 Servo function 11**

---

**bit1: fctcfw Full-closed torsion compensation function forward direction compensation enabled**

Compensate the torsion amount in the forward direction with the full-closed torsion compensation function. When compensating the torsion amount in the reverse direction only, set to "0".

0: Stop 1: Start

---

**(PR) #2317 SV117 RNG1ex Expansion sub side encoder resolution**

---

For high-accuracy binary resolution encoder, set the number of pulses to four bite data of SV117 (high-order) and SV019 (low-order) by pulse (p).  
When SV117=0, the setting unit of SV019 is (kp).  
Refer to SV019 for details.

Related parameters: SV019, SV020, SV118

**---Setting range---**

-1 to 32767

---

**(PR) #2318 SV118 RNG2ex Expansion main side encoder resolution**

---

When using high-accuracy binary resolution encoder, set the number of pulses to four bite data of SV118 (high-order) and SV020 (low-order) by pulse (p).  
When SV118=0, the setting unit of SV020 is (kp).  
Refer to SV020 for details.

Related parameters: SV019, SV020, SV117

**---Setting range---**

-1 to 32767

---

**#2319-2328 SV119 - SV128**

---

Not used. Set to "0".

---

**#2329 SV129 Kwf Synchronous control feed forward filter frequency**

---

Set the acceleration rate feed forward filter frequency in high-speed synchronous tapping control. The standard setting is "600".

Related parameters: SV244

**---Setting range---**

0 to 32767 (rad/s)

---

**(PR) #2330 SV130 RPITS Base reference mark interval**

---

Set the base reference mark intervals of distance-coded reference scale. When the distance-coded reference scale is not used, set to "0".  
The interval of basic reference mark (SV130) and auxiliary interval (SV131) must be in the specified relationship. Other settings cause the initial parameter error (alarm 37).  
Following is the specified relationship.

The quotient of  $(SV130 \times 1000) / SV131$  must be 4 or more and leaves no remainder.

Related parameters: SV081/bit7,3, SV131, SV134 to SV137

**---Setting range---**

0 to 32767 (mm)



(PR)	#2331	SV131 DPITS	Auxiliary reference mark interval
			<p>Set the auxiliary interval of reference mark in the distance-coded reference scale. When the distance-coded reference scale is not used, set to "0".</p> <p>The interval of basic reference mark (SV130) and auxiliary interval (SV131) must be in the specified relationship. Other settings cause the initial parameter error (alarm 37). Following is the specified relationship.</p> <p>The quotient of <math>(SV130 \times 1000) / SV131</math> must be 4 or more and leaves no remainder.</p> <p>Related parameters: SV081/bit7,3, SV130, SV134 to SV137</p> <p>---Setting range---</p> <p>0 to 32767 (<math>\mu\text{m}</math>)</p>
	#2332	SV132	Not used. Set to "0".
	#2333	SV133	Not used. Set to "0".
	#2334	SV134 RRn0	Distance-coded reference check / revolution counter
			<p>Set this parameter to operate distance-coded reference check when using distance-coded reference scale. During the distance-coded reference check initial setup (SV137:RAER=-1), set the following items on the NC drive monitor screen after the distance-coded reference check initial setup warning A3 turns OFF.</p> <p>SV134=Rn, SV135=Pn, SV136=MPOS</p> <p>When reference point is set, the warning A3 turns OFF.</p> <p>To enable the distance-coded reference check function, SV081/bit3=1 setting and a battery option are needed.</p> <p>Related parameters: SV081/bit3,7, SV130, SV131, SV134 to SV137</p> <p>---Setting range---</p> <p>-32768 to 32767</p>
	#2335	SV135 RPn0H	Distance-coded reference check / position within one rotation High
			<p>Set this parameter to operate distance-coded reference check when using distance-coded reference scale. During the distance-coded reference check initial setup (SV137:RAER=-1), set the following items on the NC drive monitor screen after the distance-coded reference check initial setup warning A3 turns OFF.</p> <p>SV134=Rn, SV135=Pn, SV136=MPOS</p> <p>When reference point is set, the warning A3 turns OFF.</p> <p>To enable the distance-coded reference check function, SV081/bit3=1 setting and a battery option are needed.</p> <p>Related parameters: SV081/bit3,7, SV130, SV131, SV134 to SV137</p> <p>---Setting range---</p> <p>-32768 to 32767</p>
	#2336	SV136 RPn0L	Distance-coded reference check / position within one rotation Low
			<p>Set this parameter to operate distance-coded reference check when using distance-coded reference scale. During the distance-coded reference check initial setup (SV137:RAER=-1), set the following items on the NC drive monitor screen after the distance-coded reference check initial setup warning A3 turns OFF.</p> <p>SV134=Rn, SV135=Pn, SV136=MPOS</p> <p>When reference point is set, the warning A3 turns OFF.</p> <p>To enable the distance-coded reference check function, SV081/bit3=1 setting and a battery option are needed.</p> <p>Related parameters: SV081/bit3,7, SV130, SV131, SV134 to SV137</p> <p>---Setting range---</p> <p>-32768 to 32767</p>

#2337	SV137 RAER	Distance-coded reference check allowable width
		<p>For the distance-coded reference check function when using distance-coded reference scale, set the allowable gap from the reference point position data calculated by the main side encoder. When the gap exceeds the allowable range, reference point created by distance-code is judged as wrong and detects alarm 42. The standard setting value is "basic reference mark interval (SV130) / 4".</p> <p>SV137=0 setting carries out the same operation as the standard setting value.</p> <p>SV137=-1 setting enables the distance-coded reference initial set up mode and displays setting values of SV134 to SV136 on NC drive monitor.</p> <p>To enable the distance-coded reference check function, SV081/bit3=1 setting and a battery option are needed.</p> <p>When SV137=32767, the distance-coded reference check function is disabled.</p> <p>Related parameters: SV081/bit3,7, SV130, SV131, SV134 to SV136</p> <p>---Setting range---</p> <p>-1 to 32767 (mm)</p>

#2338-2397	SV138 - SV197	
		Not used. Set to "0".

#2398	SV198 NSE	No signal 2 special detection width
		<p>Set the special detection width for the no signal 2 (alarm 21).</p> <p>This detects no signal 2 (alarm 21) when machine side feedback is not invoked even if the motor side encoder feedback exceeds this setting in the rectangular wave signal output linear scale.</p> <p>When "0" is set, the detection will be performed with a 15µm width.</p> <p>---Setting range---</p> <p>0 to 32767 (µm)</p>

#2399	SV199 RTGM	Real-time tuning: maximum adaptive gain multiplier
		<p>In case that machine resonance is induced when mounting a workpiece, the speed loop gain is switched automatically in response to inertia by setting the speed loop gain and workpiece inertia multiplier in advance.</p> <p>The speed loop gain SV199(RTGM) changes in response to the estimated inertia ratio SV200(RTJX) based on the speed loop gain SV005(VGN1) and the inertia multiplier SV037(JL) which were adjusted when no workpiece was mounted.</p> <p>When SV199 is set to "0", the adaptation of the speed loop gain will be disabled.</p>

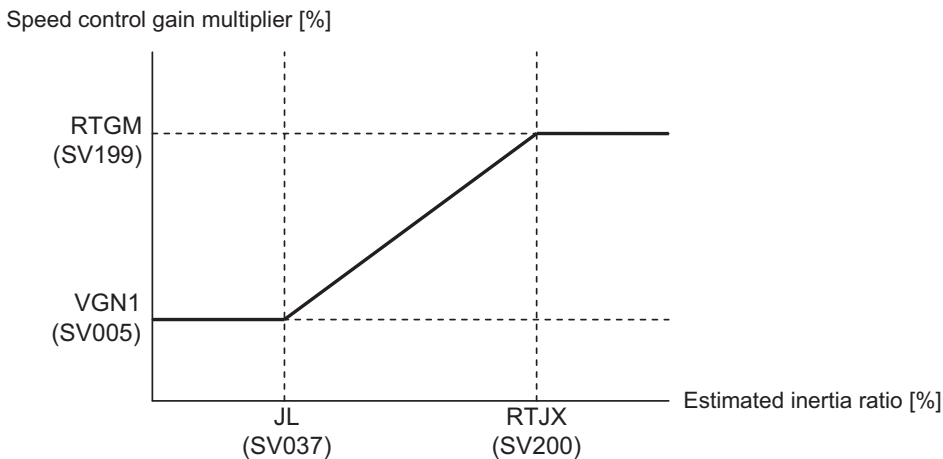

Related parameters: SV005, SV037, SV200

---Setting range---

0 to 5000 (%)

**#2400 SV200 RTJX Real-time tuning: maximum adaptive inertia ratio**

In case that machine resonance is induced when mounting a workpiece, the speed loop gain is switched automatically in response to inertia by setting the speed loop gain and workpiece inertia multiplier in advance.

The speed loop gain SV199(RTGM) changes in response to the estimated inertia ratio SV200(RTJX) based on the speed loop gain SV005(VGN1) and the inertia multiplier SV037(JL) which were adjusted when no workpiece was mounted.

When SV199 is set to "0", the adaptation of the speed loop gain will be disabled.

Speed control gain multiplier [%]

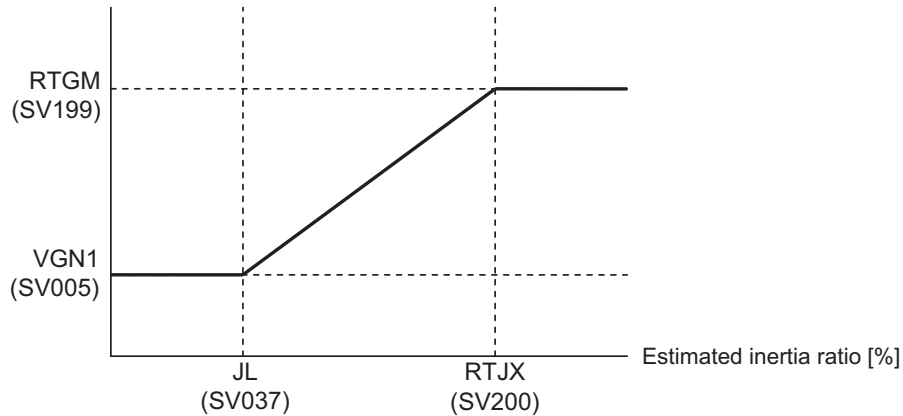

Related parameters: SV005, SV037, SV199

**---Setting range---**

0 to 32767 (%)

**#2401-2405 SV201 - SV205**

Not used. Set to "0".

**#2406 SV206 FCTC Full-closed torsion compensation control torsion amount**

Set the compensation amount of full-closed torsion compensation function.

Set the torsion amount between the motor-end position and the machine-end position right after the stop as a standard setting value.

When not using, set to "0".

**---Setting range---**

0 to 32767 (0.01µm)

**#2407-2436 SV207 - SV236**

Not used. Set to "0".

**(PR) #2437 SV237 TCF Torque command filter**

Set the filter for the torque command.

The standard value is "3000" when using HG46, HG56, or HG96.

**---Setting range---**

0 to 5000 (rad/s)

**#2438 SV238 SSCFEED Safely limited speed**

Set the machine's safely limited speed for the SLS (Safely Limited Speed) function.

Set this parameter within the following setting ranges.

For linear axis: 2000mm/min or less

For rotary axis: 18000°/min (50r/min) or less

When not using, set to "0".

**---Setting range---**

0 to 18000 (mm/min) or (°/min)

However, when SV033/bitD = 1, the setting range is from -32768 to 32767 (100mm/min) or (100°/min).

#2439	SV239 SSCRPM	Safely limited motor speed
		<p>Set the motor's safely limited speed for the SLS (Safely Limited Speed) function.</p> <p>Set a value to hold the following relationship.</p> <p>Be aware when setting the parameter as the setting units for general motors and linear motors are different.</p> <p>&lt;&lt;For general motor&gt;&gt;</p> $SV239 = (SV238/SV018) \times (SV002/SV001)$ <p>Only when the product is 0, set to "1".</p> <p>&lt;&lt;For linear motor&gt;&gt;</p> $SV239 = SV238/60$ <p>Only when the product is 0, set to "1".</p> <p>When not using, set to "0".</p> <p><b>---Setting range---</b></p> <p>For general motor: 0 to 32767 (r/min)</p> <p>For linear motor: 0 to 32767 (mm/s)</p> <p>(Note) The value of the safely limited speed and safely limited motor speed must satisfy the above relation. If this relation is not satisfied, the parameter error (37 or E4) will occur. (Error parameter No. is 239.) Checking this relation is executed when the drive unit is turned ON and parameter is changed and speed observation mode (states when a speed observation command is turned ON) is entered.</p> $\frac{SV238 :SSCFEED}{SV018 :PIT} \times \frac{SV002 :PC2}{SV001 :PC1} = SV239 :SSCRPM$ <p>Note that "1 (r/min)" is applied when the calculation result is "0 (r/min)"</p>
#2440-2443	SV240 - SV243	Not used. Set to "0".
(PR) #2444	SV244 DUNIT	Communication interpolation unit for communication among drive units
		<p>Set the communication interpolation unit among drive units in high-speed synchronous tapping control. When set to "0", it will be regarded as 20 (0.05μm) is set.</p> <p>Related parameters: SV129</p> <p><b>---Setting range---</b></p> <p>0 to 2000 (1/μm)</p>
#2445-2456	SV245 - SV256	Not used. Set to "0".

## 16.8 Spindle Specification Parameters

<b>#3001</b>	<b>slimt1</b>	<b>Limit rotation speed (Gear: 00)</b>
Set the spindle rotation speed for maximum motor speed when gear 00 is selected.		
Set the spindle rotation speed for the S analog output=10V during analog spindle control.		
<b>---Setting range---</b>		
0 to 999999 (r/min)		
<b>#3002</b>	<b>slimt2</b>	<b>Limit rotation speed (Gear: 01)</b>
Set the spindle rotation speed for maximum motor speed when gear 01 is selected.		
Set the spindle rotation speed for the S analog output=10V during analog spindle control.		
<b>---Setting range---</b>		
0 to 999999 (r/min)		
<b>#3003</b>	<b>slimt3</b>	<b>Limit rotation speed (Gear: 10)</b>
Set the spindle rotation speed for maximum motor speed when gear 10 is selected.		
Set the spindle rotation speed for the S analog output=10V during analog spindle control.		
<b>---Setting range---</b>		
0 to 999999 (r/min)		
<b>#3004</b>	<b>slimt4</b>	<b>Limit rotation speed (Gear: 11)</b>
Set the spindle rotation speed for maximum motor speed when gear 11 is selected.		
Set the spindle rotation speed for the S analog output=10V during analog spindle control.		
<b>---Setting range---</b>		
0 to 999999 (r/min)		
<b>#3005</b>	<b>smax 1</b>	<b>Maximum rotation speed (Gear: 00)</b>
Set the maximum spindle rotation speed which is actually commanded when gear 00 is selected.		
Set this as $smax1(\#3005) \leq slimt1(\#3001)$ .		
By comparing the S command value and the values of gear 1 - 4, a spindle gear shift command will be output automatically.		
<b>---Setting range---</b>		
0 to 999999 (r/min)		
<b>#3006</b>	<b>smax 2</b>	<b>Maximum rotation speed (Gear: 01)</b>
Set the maximum spindle rotation speed which is actually commanded when gear 01 is selected.		
Set this as $smax2(\#3006) \leq slimt2(\#3002)$ .		
By comparing the S command value and the values of gear 1 - 4, a spindle gear shift command will be output automatically.		
<b>---Setting range---</b>		
0 to 999999 (r/min)		
<b>#3007</b>	<b>smax 3</b>	<b>Maximum rotation speed (Gear: 10)</b>
Set the maximum spindle rotation speed which is actually commanded when gear 10 is selected.		
Set this as $smax3(\#3007) \leq slimt3(\#3003)$ .		
By comparing the S command value and the values of gear 1 - 4, a spindle gear shift command will be output automatically.		
<b>---Setting range---</b>		
0 to 999999 (r/min)		
<b>#3008</b>	<b>smax 4</b>	<b>Maximum rotation speed (Gear: 11)</b>
Set the maximum spindle rotation speed which is actually commanded when gear 11 is selected.		
Set this as $smax4(\#3008) \leq slimt4(\#3004)$ .		
By comparing the S command value and the values of gear 1 - 4, a spindle gear shift command will be output automatically.		
<b>---Setting range---</b>		
0 to 999999 (r/min)		

<b>#3009</b>	<b>ssift 1</b>	<b>Shift rotation speed (Gear: 00)</b>
Set the spindle speed for gear shifting with gear 00. (Note) Setting too large value may cause a gear nick when changing gears.		
<b>---Setting range---</b>		
0 to 32767 (r/min)		
<b>#3010</b>	<b>ssift 2</b>	<b>Shift rotation speed (Gear: 01)</b>
Set the spindle speed for gear shifting with gear 01. (Note) Setting too large value may cause a gear nick when changing gears.		
<b>---Setting range---</b>		
0 to 32767 (r/min)		
<b>#3011</b>	<b>ssift 3</b>	<b>Shift rotation speed (Gear: 10)</b>
Set the spindle speed for gear shifting with gear 10. (Note) Setting too large value may cause a gear nick when changing gears.		
<b>---Setting range---</b>		
0 to 32767 (r/min)		
<b>#3012</b>	<b>ssift 4</b>	<b>Shift rotation speed (Gear: 11)</b>
Set the spindle speed for gear shifting with gear 11. (Note) Setting too large value may cause a gear nick when changing gears.		
<b>---Setting range---</b>		
0 to 32767 (r/min)		
<b>#3013</b>	<b>stap 1</b>	<b>Synchronous tapping 1st step rotation speed (Gear: 00)</b>
Set the speed which switches from 1st step to 2nd step in synchronous tapping multi-step acceleration/deceleration control when gear 00 is selected. The inclination of linear acceleration/deceleration control for 1st step is determined by the ratio of "stap1" (#3013) to "stapt1" (#3017). When the inclination is not set after 2nd step or it is higher than that of 1st step, the acceleration/deceleration control is executed with the same inclination as the 1st step for the rotation speed of "stap1" or higher.		
<b>---Setting range---</b>		
0 to 99999 (r/min)		
<b>#3014</b>	<b>stap 2</b>	<b>Synchronous tapping 1st step rotation speed (Gear: 01)</b>
Set the speed which switches from 1st step to 2nd step in synchronous tapping multi-step acceleration/deceleration control when gear 01 is selected. The inclination of linear acceleration/deceleration control for 1st step is determined by the ratio of "stap2" (#3014) to "stapt2" (#3018). When the inclination is not set after 2nd step or it is higher than that of 1st step, the acceleration/deceleration control is executed with the same inclination as the 1st step for the rotation speed of "stap2" or higher.		
<b>---Setting range---</b>		
0 to 99999 (r/min)		
<b>#3015</b>	<b>stap 3</b>	<b>Synchronous tapping 1st step rotation speed (Gear: 10)</b>
Set the speed which switches from 1st step to 2nd step in synchronous tapping multi-step acceleration/deceleration control when gear 10 is selected. The inclination of linear acceleration/deceleration control for 1st step is determined by the ratio of "stap3" (#3015) to "stapt3" (#3019). When the inclination is not set after 2nd step or it is higher than that of 1st step, the acceleration/deceleration control is executed with the same inclination as the 1st step for the rotation speed of "stap3" or higher.		
<b>---Setting range---</b>		
0 to 99999 (r/min)		

<b>#3016</b>	<b>stap 4</b>	<b>Synchronous tapping 1st step rotation speed (Gear: 11)</b>
<p>Set the speed which switches from 1st step to 2nd step in synchronous tapping multi-step acceleration/deceleration control when gear 11 is selected.</p> <p>The inclination of linear acceleration/deceleration control for 1st step is determined by the ratio of "stap4" (#3016) to "stap1" (#3020).</p> <p>When the inclination is not set after 2nd step or it is higher than that of 1st step, the acceleration/deceleration control is executed with the same inclination as the 1st step for the rotation speed of "stap4" or higher.</p> <p><b>---Setting range---</b></p> <p>0 to 99999 (r/min)</p>		
<b>#3017</b>	<b>stap 1</b>	<b>Synchronous tapping 1st step acceleration/deceleration time constant (Gear: 00)</b>
<p>Set the time constant for synchronous tapping 1st step linear acceleration/deceleration control when gear 00 is selected. (linear acceleration/deceleration pattern)</p> <p><b>---Setting range---</b></p> <p>1 to 5000 (ms)</p>		
<b>#3018</b>	<b>stap 2</b>	<b>Synchronous tapping 1st step acceleration/deceleration time constant (Gear: 01)</b>
<p>Set the time constant for synchronous tapping 1st step linear acceleration/deceleration control when gear 01 is selected. (linear acceleration/deceleration pattern)</p> <p><b>---Setting range---</b></p> <p>1 to 5000 (ms)</p>		
<b>#3019</b>	<b>stap 3</b>	<b>Synchronous tapping 1st step acceleration/deceleration time constant (Gear: 10)</b>
<p>Set the time constant for synchronous tapping 1st step linear acceleration/deceleration control when gear 10 is selected. (linear acceleration/deceleration pattern)</p> <p><b>---Setting range---</b></p> <p>1 to 5000 (ms)</p>		

#3020

stapt 4

Synchronous tapping 1st step acceleration/deceleration time constant (Gear: 11)

Set the time constant for synchronous tapping 1st step linear acceleration/deceleration control when gear 11 is selected. (linear acceleration/deceleration pattern)

---Setting range---

1 to 5000 (ms)

<Relation of spindle limit rotation speed and spindle maximum rotation speed>

The spindle rotation speed which can be attained at the spindle motor's maximum rotation speed is set for the limit rotation speed (slimt). This value is obtained by multiplying the gear ratio on the spindle motor maximum rotation speed (SP026). Set the maximum rotation speed (smax) when the rotation speed is to be limited according to the machine specifications, such as the spindle gear specifications. Up to four value can be set for gear changeover.

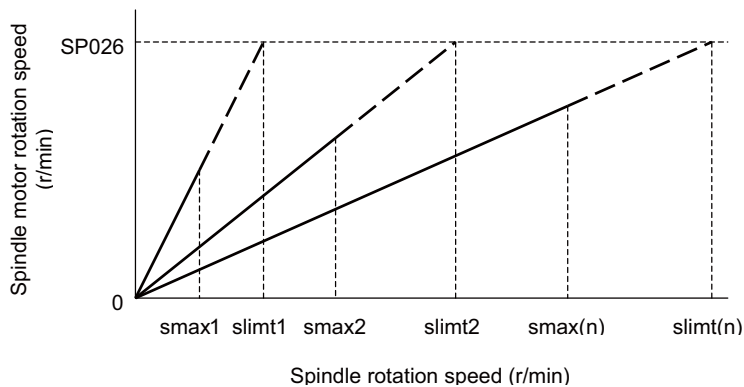

<Synchronous tapping multi-step acceleration/deceleration control parameter>

The acceleration/deceleration control can be set up to three steps in synchronous tapping control to carry out an optimal acceleration/deceleration control in accordance with the spindle motor characteristics whose output torque steps down when exceeding the base rotation speed.

Set the inclination for 2nd step or subsequent steps when the maximum rotation speed exceeds the base rotation speed during synchronous tapping control.

When the inclination is not set after 2nd step or it is higher than that of 1st step, the acceleration/deceleration control is executed with the same inclination as the 1st step for all the rotation speed.

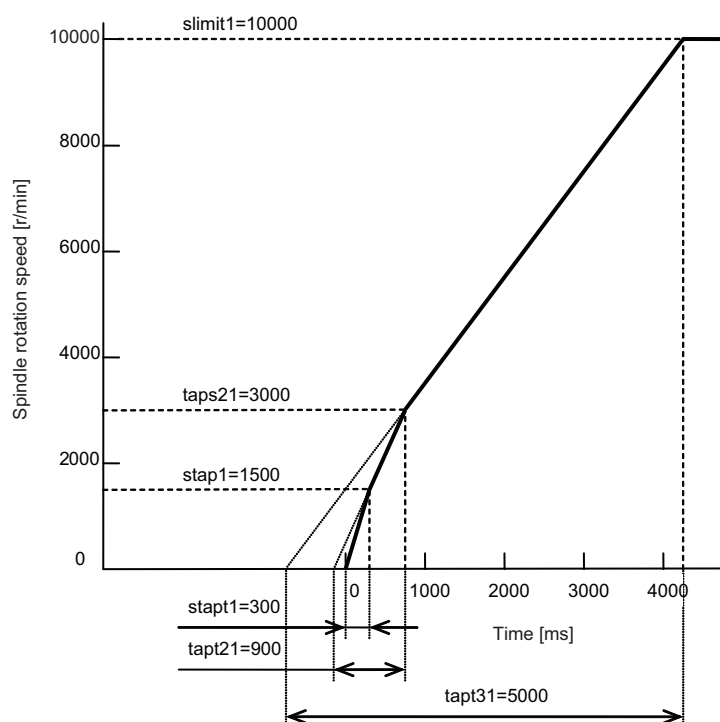



<Spindle synchronization multi-step acceleration/deceleration control parameter>

The acceleration/deceleration control can be set up to eight steps in spindle synchronization control to carry out an optimal acceleration/deceleration control in accordance with the spindle motor characteristics whose output torque steps down when exceeding the base rotation speed and further attenuate in output stepdown zone.

For 2nd step or subsequent steps, the specification allows to set the time constant magnification and changeover rotation speed based on the acceleration/deceleration setting of the 1st step.

Set the value of limit rotation speed or higher as the changeover rotation speed for the step not to be shifted when not carrying out a step shift.

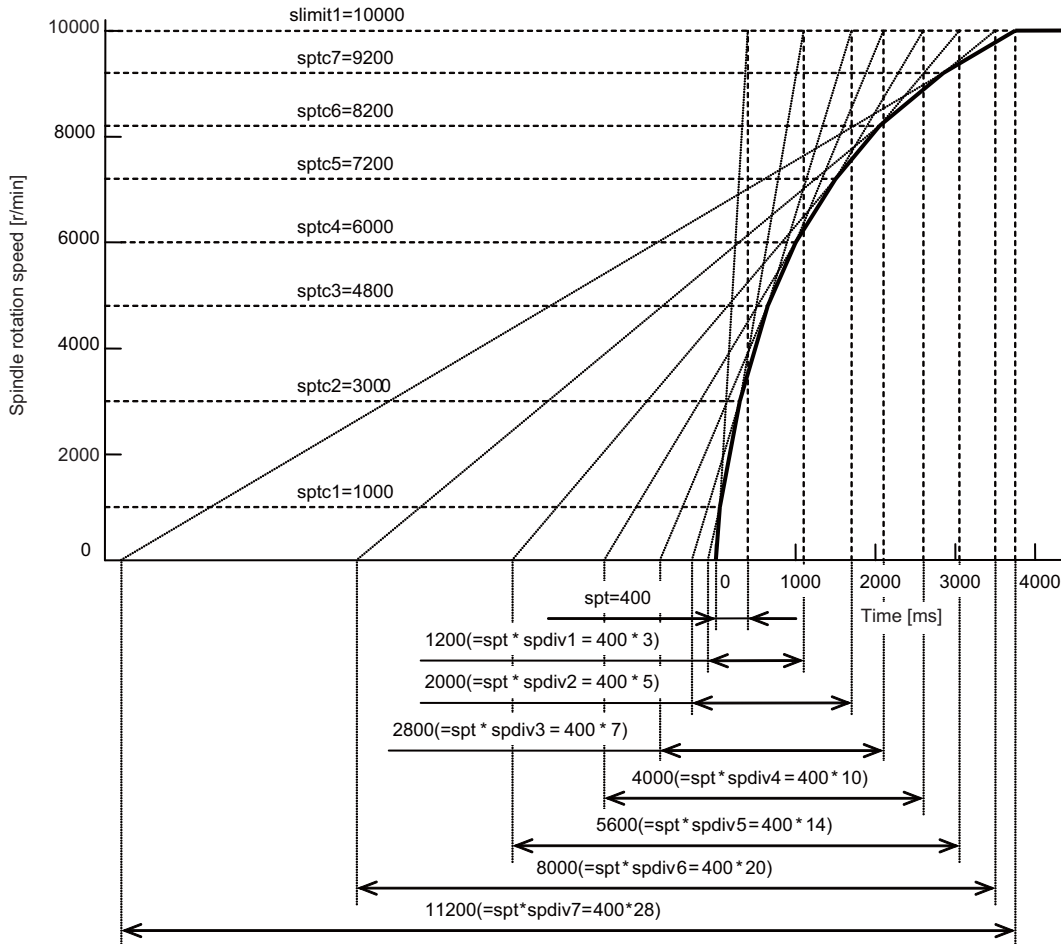

#3021

Not used. Set to "0".

#3022

sgear

Encoder gear ratio

Set the deceleration rate of the encoder to the spindle when inputting ABZ pulse output encoder feedback to NC during analog spindle control.

- 0: 1/1
- 1: 1/2
- 2: 1/4
- 3: 1/8

---Setting range---

0 to 3

	<b>#3023</b>	<b>smini</b>	<b>Minimum rotation speed</b>
		Set the minimum spindle speed. If an S command below this setting is issued, the spindle will rotate at the minimum speed set by this parameter.	
		<b>---Setting range---</b>	
		0 to 32767 (r/min)	
<b>(PR)</b>	<b>#3024</b>	<b>sout</b>	<b>Spindle connection interface</b>
		Select the connection interface with the spindle drive unit.	
		0: No unit to connect	
		1: Digital optical (Mitsubishi spindle drive unit)	
		2-5: S-analog (Analog I/F spindle drive unit)	
<b>(PR)</b>	<b>#3025</b>	<b>enc-on</b>	<b>Spindle encoder</b>
		Set the connection specifications of a spindle's encoder.	
		0: Without encoder feedback when using analog spindle and connecting to NC	
		1: With encoder feedback when using analog spindle and connecting to NC	
		2: Mitsubishi spindle drive unit	
	<b>#3026</b>	<b>cs_ori</b>	<b>Selection of winding in orientation mode</b>
		Select the coil control in orientation mode for the spindle motor which performs coil changeover.	
		0: Perform coil changeover based on the command from NC. (depending on the setting of parameter #1239/bit0)	
		1: Use the coil L	
	<b>#3027</b>	<b>cs_syn</b>	<b>Selection of winding in spindle synchronization control mode</b>
		Select the coil control in spindle synchronization control mode for the spindle motor which performs coil changeover.	
		0: Perform coil changeover based on the command from NC. (depending on the setting of parameter #1239/bit0)	
		1: Use the coil H	
	<b>#3028</b>	<b>sprcmm</b>	<b>Tap cycle M command selection</b>
		Set the M codes for the spindle forward run/reverse run commands during tapping cycle.	
		High-order 3 digits: Set the M code for spindle forward run command.	
		Low-order 3 digits: Set the M code for spindle reverse run command.	
		When "0" is set, it is handled assuming that "3004" is set (the M code for spindle forward run command is "3" and the M code for spindle reverse run command is "4").	
		<b>---Setting range---</b>	
		0 to 999999	
	<b>#3029</b>	<b>tapsel</b>	<b>Asynchronous tap gear selection</b>
		Select the speed which is compared with S command at gear selection when using asynchronous tapping control with the spindle which performs gear changeover.	
		0: Synchronous tapping 1st step rotation speed (stap)--- Multi-step acceleration/deceleration is not used.	
		1: Maximum speed (smax)--- Multi-step acceleration/deceleration is used.	
		This parameter is enabled only when "#1272 ext08/bit1 is 1".	
	<b>#3030</b>		
		Not used. Set to "0".	

<b>(PR)</b>	<b>#3031</b>	<b>smcp_no</b>	<b>Drive unit I/F channel No. (spindle)</b>
-------------	--------------	----------------	---

Set the interface channel No. of CNC control unit to which the spindle is connected and the axis No. within each channel.  
Set this parameter in 4-digit hexadecimal format.

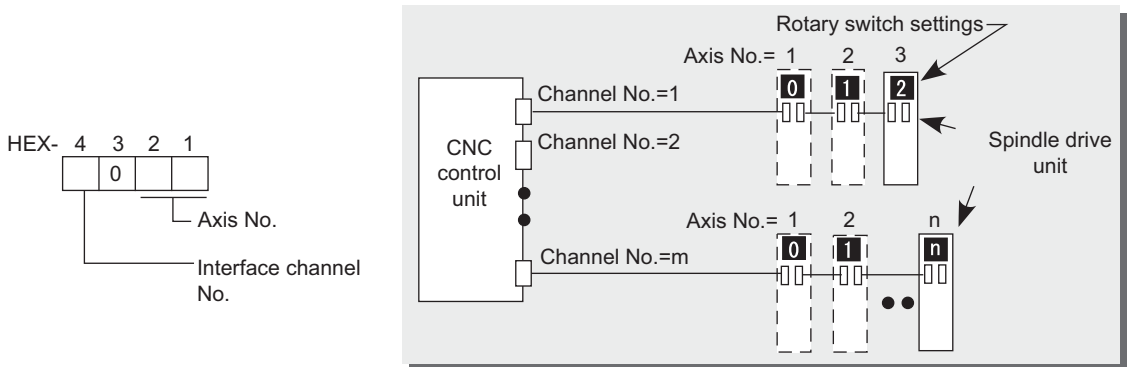

HEX-4: Drive unit interface channel No.  
HEX-3: Not used. Set to "0".  
HEX-2, 1: Axis No.  
For an analog spindle, set to "0000".

**---Setting range---**

0000, 1001 to 1010, 2001 to 2010

	<b>#3032</b>		Not used. Set to "0".
--	--------------	--	-----------------------

<b>(PR)</b>	<b>#3035</b>	<b>spunit</b>	<b>Output unit</b>
-------------	--------------	---------------	--------------------

Select the data unit for communication with the spindle drive unit.  
This selection is applied to the data communicated between the NC and spindle drive unit as well as the spindle movement data. Although the standard setting is B (0.001deg), set the same value as "#1004 ctrl\_unit" when using Spindle/C axis control.  
B: 0.001deg (1μm)  
C: 0.0001deg (0.1μm)  
D: 0.00001deg (10nm)  
E: 0.000001deg (1nm)

	<b>#3037</b>	<b>taps21</b>	<b>Synchronous tapping 2nd step rotation speed (Gear: 00)</b>
--	--------------	---------------	---

Set the speed which switches from 2nd step to 3rd step in synchronous tapping multi-step acceleration/deceleration control when gear 00 is selected.  
The inclination of linear acceleration/deceleration control for 2nd step is determined by the ratio of "taps21" (#3037) to "tapt21" (#3041).  
When the inclination is not set for 3rd step or it is higher than that of 2nd step, the acceleration/deceleration control is executed with the same inclination as the 2nd step for the rotation speed of "taps21" or higher.

**---Setting range---**

0 to 99999 (r/min)

	<b>#3038</b>	<b>taps22</b>	<b>Synchronous tapping 2nd step rotation speed (Gear: 01)</b>
--	--------------	---------------	---

Set the speed which switches from 2nd step to 3rd step in synchronous tapping multi-step acceleration/deceleration control when gear 01 is selected.  
The inclination of linear acceleration/deceleration control for 2nd step is determined by the ratio of "taps22" (#3038) to "tapt22" (#3042).  
When the inclination is not set for 3rd step or it is higher than that of 2nd step, the acceleration/deceleration control is executed with the same inclination as the 2nd step for the rotation speed of "taps22" or higher.

**---Setting range---**

0 to 99999 (r/min)

<b>#3039</b>	<b>taps23</b>	<b>Synchronous tapping 2nd step rotation speed (Gear: 10)</b>
<p>Set the speed which switches from 2nd step to 3rd step in synchronous tapping multi-step acceleration/deceleration control when gear 10 is selected.  The inclination of linear acceleration/deceleration control for 2nd step is determined by the ratio of "taps23" (#3039) to "tapt23" (#3043).  When the inclination is not set for 3rd step or it is higher than that of 2nd step, the acceleration/deceleration control is executed with the same inclination as the 2nd step for the rotation speed of "taps23" or higher.</p> <p><b>---Setting range---</b>  0 to 99999 (r/min)</p>		
<b>#3040</b>	<b>taps24</b>	<b>Synchronous tapping 2nd step rotation speed (Gear: 11)</b>
<p>Set the speed which switches from 2nd step to 3rd step in synchronous tapping multi-step acceleration/deceleration control when gear 11 is selected.  The inclination of linear acceleration/deceleration control for 2nd step is determined by the ratio of "taps24" (#3040) to "tapt24" (#3044).  When the inclination is not set for 3rd step or it is higher than that of 2nd step, the acceleration/deceleration control is executed with the same inclination as the 2nd step for the rotation speed of "taps24" or higher.</p> <p><b>---Setting range---</b>  0 to 99999 (r/min)</p>		
<b>#3041</b>	<b>tapt21</b>	<b>Synchronous tapping 2nd step acceleration/deceleration time constant (Gear: 00)</b>
<p>Set the time constant for synchronous tapping 2nd step linear acceleration/deceleration control when gear 00 is selected.</p> <p><b>---Setting range---</b>  1 to 5000 (ms)</p>		
<b>#3042</b>	<b>tapt22</b>	<b>Synchronous tapping 2nd step acceleration/deceleration time constant (Gear: 01)</b>
<p>Set the time constant for synchronous tapping 2nd step linear acceleration/deceleration control when gear 01 is selected.</p> <p><b>---Setting range---</b>  1 to 5000 (ms)</p>		
<b>#3043</b>	<b>tapt23</b>	<b>Synchronous tapping 2nd step acceleration/deceleration time constant (Gear: 10)</b>
<p>Set the time constant for synchronous tapping 2nd step linear acceleration/deceleration control when gear 10 is selected.</p> <p><b>---Setting range---</b>  1 to 5000 (ms)</p>		
<b>#3044</b>	<b>tapt24</b>	<b>Synchronous tapping 2nd step acceleration/deceleration time constant (Gear: 11)</b>
<p>Set the time constant for synchronous tapping 2nd step linear acceleration/deceleration control when gear 11 is selected.</p> <p><b>---Setting range---</b>  1 to 5000 (ms)</p>		
<b>#3045</b>	<b>tapt31</b>	<b>Synchronous tapping 3rd step acceleration/deceleration time constant (Gear: 00)</b>
<p>Set the time constant for synchronous tapping 3rd step linear acceleration/deceleration control when gear 00 is selected.</p> <p>The inclination of linear acceleration/deceleration control for 3rd step is determined by the ratio of slim-it1(#3001) to tapt31(#3045).</p> <p><b>---Setting range---</b>  1 to 5000 (ms)</p>		

<b>#3046</b>	<b>tapt32</b>	<b>Synchronous tapping 3rd step acceleration/deceleration time constant (Gear: 01)</b>
<p>Set the time constant for synchronous tapping 3rd step linear acceleration/deceleration control when gear 01 is selected.</p> <p>The inclination of linear acceleration/deceleration control for 3rd step is determined by the ratio of slimit2 (#3002) to tapt32 (#3046).</p> <p>---Setting range---</p> <p>1 to 5000 (ms)</p>		
<b>#3047</b>	<b>tapt33</b>	<b>Synchronous tapping 3rd step acceleration/deceleration time constant (Gear: 10)</b>
<p>Set the time constant for synchronous tapping 3rd step linear acceleration/deceleration control when gear 10 is selected.</p> <p>The inclination of linear acceleration/deceleration control for 3rd step is determined by the ratio of slimit3 (#3003) to tapt33 (#3047).</p> <p>---Setting range---</p> <p>1 to 5000 (ms)</p>		
<b>#3048</b>	<b>tapt34</b>	<b>Synchronous tapping 3rd step acceleration/deceleration time constant (Gear: 11)</b>
<p>Set the time constant for synchronous tapping 3rd step linear acceleration/deceleration control when gear 11 is selected.</p> <p>The inclination of linear acceleration/deceleration control for 3rd step is determined by the ratio of slimit4 (#3004) to tapt34 (#3048).</p> <p>---Setting range---</p> <p>1 to 5000 (ms)</p>		
<b>#3049</b>	<b>spt</b>	<b>Spindle synchronization acceleration/deceleration time constant</b>
<p>Set the acceleration/deceleration time constant under spindle synchronization control.</p> <p>The inclination of acceleration/deceleration control is determined by the ratio to limit rotation speed (slimit). Set the same value for the reference axis and synchronized axis.</p> <p>The time constant for 2nd step or subsequent steps is the magnification setting on the basis of this setting value.</p> <p>---Setting range---</p> <p>0 to 9999 (ms)</p>		
<b>#3050</b>	<b>sprlv</b>	<b>Spindle synchronization rotation speed attainment level</b>
<p>Set the level of speed difference between the reference and synchronized spindles during spindle synchronization control. Setting of the synchronized spindle side is enabled. When the difference becomes below the setting level, the spindle speed synchronization complete signal will turn ON.</p> <p>---Setting range---</p> <p>0 to 4095 (pulse) (1 pulse = 0.088°)</p>		
<b>#3051</b>	<b>splv</b>	<b>Spindle phase synchronization attainment level</b>
<p>Set the level of phase difference between the reference and synchronized spindles during spindle synchronization. Setting of the synchronized spindle side is enabled. When the difference becomes below the setting level, the spindle phase synchronization complete signal will go ON.</p> <p>---Setting range---</p> <p>0 to 4095 (pulse) (1 pulse = 0.088°)</p>		
<b>#3052</b>	<b>spplr</b>	<b>Spindle synchronization relative polarity</b>
<p>Set the polarity to match the rotation direction between the spindles which perform synchronization control under spindle synchronization control.</p> <p>0: Positive polarity (Spindle CW rotation at motor CW rotation) 1: Negative polarity (Spindle CCW rotation at motor CW rotation)</p> <p>---Setting range---</p> <p>0000/0001 (HEX)</p>		

<b>#3053</b>	<b>sppst</b>	<b>Spindle encoder Z -phase position</b>
<p>Set the deviation amount from the spindle's basic point to the spindle encoder's Z phase. Obtain the deviation amount, considering a clockwise direction as positive when viewed from the spindle's front side.</p> <p><b>---Setting range---</b> 0 to 359999 (1/1000°)</p>		
<b>#3054</b>	<b>sptc1</b>	<b>Spindle synchronization multi-step acceleration/deceleration changeover speed 1</b>
<p>Set the speed which switches from 1st step to 2nd step in spindle synchronization multi-step acceleration/deceleration control. Set the same value for the reference axis and synchronized axis. Set the value of limit rotation speed (slimit) or higher not to carry out a step shift.</p> <p><b>---Setting range---</b> 0 to 99999 (r/min)</p>		
<b>#3055</b>	<b>sptc2</b>	<b>Spindle synchronization multi-step acceleration/deceleration changeover speed 2</b>
<p>Set the speed which switches from 2nd step to 3rd step in spindle synchronization multi-step acceleration/deceleration control. Set the same value for the reference axis and synchronized axis. Set the value of limit rotation speed (slimit) or higher not to carry out a step shift.</p> <p><b>---Setting range---</b> 0 to 99999 (r/min)</p>		
<b>#3056</b>	<b>sptc3</b>	<b>Spindle synchronization multi-step acceleration/deceleration changeover speed 3</b>
<p>Set the speed which switches from 3rd step to 4th step in spindle synchronization multi-step acceleration/deceleration control. Set the same value for the reference axis and synchronized axis. Set the value of limit rotation speed (slimit) or higher not to carry out a step shift.</p> <p><b>---Setting range---</b> 0 to 99999 (r/min)</p>		
<b>#3057</b>	<b>sptc4</b>	<b>Spindle synchronization multi-step acceleration/deceleration changeover speed 4</b>
<p>Set the speed which switches from 4th step to 5th step in spindle synchronization multi-step acceleration/deceleration control. Set the same value for the reference axis and synchronized axis. Set the value of limit rotation speed (slimit) or higher not to carry out a step shift.</p> <p><b>---Setting range---</b> 0 to 99999 (r/min)</p>		
<b>#3058</b>	<b>sptc5</b>	<b>Spindle synchronization multi-step acceleration/deceleration changeover speed 5</b>
<p>Set the speed which switches from 5th step to 6th step in spindle synchronization multi-step acceleration/deceleration control. Set the same value for the reference axis and synchronized axis. Set the value of limit rotation speed (slimit) or higher not to carry out a step shift.</p> <p><b>---Setting range---</b> 0 to 99999 (r/min)</p>		

<b>#3059</b>	<b>sptc6</b>	<b>Spindle synchronization multi-step acceleration/deceleration changeover speed 6</b>
<p>Set the speed which switches from 6th step to 7th step in spindle synchronization multi-step acceleration/deceleration control.</p> <p>Set the same value for the reference axis and synchronized axis.</p> <p>Set the value of limit rotation speed (slimit) or higher not to carry out a step shift.</p> <p><b>---Setting range---</b></p> <p>0 to 99999 (r/min)</p>		
<b>#3060</b>	<b>sptc7</b>	<b>Spindle synchronization multi-step acceleration/deceleration changeover speed 7</b>
<p>Set the speed which switches from 7th step to 8th step in spindle synchronization multi-step acceleration/deceleration control.</p> <p>Set the same value for the reference axis and synchronized axis.</p> <p>Set the value of limit rotation speed (slimit) or higher not to carry out a step shift.</p> <p><b>---Setting range---</b></p> <p>0 to 99999 (r/min)</p>		
<b>#3061</b>	<b>sptdiv1</b>	<b>Time constant magnification for changeover speed 1</b>
<p>Set the acceleration/deceleration time constant to be used at the speed of changeover speed 1 (sptc1) and higher in spindle synchronization multi-step acceleration/deceleration control. Set this as a magnification in relation to the spindle synchronization acceleration/deceleration time constant (spt).</p> <p><b>---Setting range---</b></p> <p>0 to 127</p>		
<b>#3062</b>	<b>sptdiv2</b>	<b>Time constant magnification for changeover speed 2</b>
<p>Set the acceleration/deceleration time constant to be used at the speed of changeover speed 2 (sptc2) and higher in spindle synchronization multi-step acceleration/deceleration control. Set this as a magnification in relation to the spindle synchronization acceleration/deceleration time constant (spt).</p> <p><b>---Setting range---</b></p> <p>0 to 127</p>		
<b>#3063</b>	<b>sptdiv3</b>	<b>Time constant magnification for changeover speed 3</b>
<p>Set the acceleration/deceleration time constant to be used at the speed of changeover speed 3 (sptc3) and higher in spindle synchronization multi-step acceleration/deceleration control. Set this as a magnification in relation to the spindle synchronization acceleration/deceleration time constant (spt).</p> <p><b>---Setting range---</b></p> <p>0 to 127</p>		
<b>#3064</b>	<b>sptdiv4</b>	<b>Time constant magnification for changeover speed 4</b>
<p>Set the acceleration/deceleration time constant to be used at the speed of changeover speed 4 (sptc4) and higher in spindle synchronization multi-step acceleration/deceleration control. Set this as a magnification in relation to the spindle synchronization acceleration/deceleration time constant (spt).</p> <p><b>---Setting range---</b></p> <p>0 to 127</p>		
<b>#3065</b>	<b>sptdiv5</b>	<b>Time constant magnification for changeover speed 5</b>
<p>Set the acceleration/deceleration time constant to be used at the speed of changeover speed 5 (sptc5) and higher in spindle synchronization multi-step acceleration/deceleration control. Set this as a magnification in relation to the spindle synchronization acceleration/deceleration time constant (spt).</p> <p><b>---Setting range---</b></p> <p>0 to 127</p>		
<b>#3066</b>	<b>sptdiv6</b>	<b>Time constant magnification for changeover speed 6</b>
<p>Set the acceleration/deceleration time constant to be used at the speed of changeover speed 6 (sptc6) and higher in spindle synchronization multi-step acceleration/deceleration control. Set this as a magnification in relation to the spindle synchronization acceleration/deceleration time constant (spt).</p> <p><b>---Setting range---</b></p> <p>0 to 127</p>		

	<b>#3067</b>	<b>spdiv7</b>	<b>Time constant magnification for changeover speed 7</b>
	Set the acceleration/deceleration time constant to be used at the speed of changeover speed 7 (sptc7) and higher in spindle synchronization multi-step acceleration/deceleration control. Set this as a magnification in relation to the spindle synchronization acceleration/deceleration time constant (spt).		
	---Setting range---		
	0 to 127		
	<b>#3068</b>	<b>symtm1</b>	<b>Phase synchronization start confirmation time</b>
	Set the time to confirm that synchronization is attained before spindle phase synchronization control is started.		
	When "0" is set, the time will be 2000ms. When "100" or less is set, the time will be 100ms.		
	---Setting range---		
	0 to 9999 (ms)		
	<b>#3069</b>	<b>symtm2</b>	<b>Phase synchronization end confirmation time</b>
	Set a period of waiting time for spindle phase synchronization control's completion as a time in which the speed stays within the attainment range.		
	When "0" is set, the time will be 500ms. When "100" or less is set, the time will be 100ms.		
	---Setting range---		
	0 to 9999(ms)		
	<b>#3070</b>	<b>syprt</b>	<b>Phase synchronization alignment speed</b>
	Set the amount of speed fluctuation of synchronized spindle during spindle phase synchronization control. Set this as a proportion to commanded speed.		
	When "0" is set, the amount will be 5%.		
	---Setting range---		
	0 to 100 (%)		
<b>(PR)</b>	<b>#3071</b>	<b>SscDrSelSp</b>	<b>Speed monitor Door selection</b>
	Select which door group of the speed monitoring a spindle belongs to.		
	0000: Belong to the door 1 group.		
	0001: Belong to the door 1 group.		
	0002: Belong to the door 2 group.		
	0003: Belong to the door 1 and 2 groups.		
	(Note) Speed monitoring function is validated when "SP229/bitF=1".		
	---Setting range---		
	0000 to 0003 (HEX)		
<b>(PR)</b>	<b>#3072</b>	<b>Ssc Svof Filter Sp</b>	<b>Speed monitor Error detection time during servo OFF</b>
	Set the error detection time for when an error of command speed monitoring or feedback speed monitoring is detected during servo OFF.		
	The alarm will occur if actual speed exceeds safe speed or safe rotation speed for a period of time longer than this setting.		
	When "0" is set, the detection time will be 200 (ms).		
	(Note) Speed monitoring function is validated when "SP229/bitF=1".		
	---Setting range---		
	0 to 9999(ms)		
	<b>#3074</b>	<b>GBsp</b>	<b>Guide bushing spindle synchronization control</b>
	Not used. Set to "0".		
<b>(PR)</b>	<b>#3077</b>	<b>Sname</b>	<b>Spindle command name</b>
	Specify a spindle name to be used for giving a spindle command.		
	When spindle command name has been set for all the spindles, the spindle name type is used. If "0" is set to any spindle, the spindle No. type is selected.		
	(Note) Do not set an identical name to two or more of all the spindles.		
	---Setting range---		
	0 to 9		



<b>#3098</b>	<b>IDD CauThresholdSp</b>	<b>Motor insulation deterioration: Caution threshold</b>
<p>Set the threshold so that "Z38 Insulation deterioration wrn 0001" could occur. When performing the insulation deterioration detection and the detected value falls below the parameter setting value, "Z38 Insulation deterioration wrn 0001" occurs.</p> <p>If "0" is set, the standard value (100 [0.1 megohm]) will be applied.</p> <p><b>---Setting range---</b></p> <p>0 to 300 (0.1 megohm)</p>		
<b>#3099</b>	<b>IDD ChgThresholdSp</b>	<b>Motor insulation deterioration: Replacement threshold</b>
<p>Set the threshold so that "Z38 Insulation deterioration wrn 0002" could occur. When performing the insulation deterioration detection and the detected value falls below the parameter setting value, "Z38 Insulation deterioration wrn 0002" occurs.</p> <p>If "0" is set, the standard value (10[0.1 megohm]) will be applied.</p> <p><b>---Setting range---</b></p> <p>0 to 300 (0.1 megohm)</p>		
<b>#3101</b>	<b>sp_t 1</b>	<b>Acceleration/deceleration time constant with S command (Gear: 00)</b>
<p>Set the acceleration/deceleration time constant with S command (speed operation mode) when gear 00 is selected. Set the linear acceleration/deceleration time up to limit rotation speed (slimit1). Set the short time constant that the motor torque at acceleration is always saturated, however, when an abnormal noise or V-belt slip occurs, increase the time constant.</p> <p><b>---Setting range---</b></p> <p>0 to 30000(ms)</p>		
<b>#3102</b>	<b>sp_t 2</b>	<b>Acceleration/deceleration time constant with S command (Gear: 01)</b>
<p>Set the acceleration/deceleration time constant with S command (speed operation mode) when gear 01 is selected. Set the linear acceleration/deceleration time up to limit rotation speed (slimit2). Set the short time constant that the motor torque at acceleration is always saturated, however, when an abnormal noise or V-belt slip occurs, increase the time constant.</p> <p><b>---Setting range---</b></p> <p>0 to 30000 (ms)</p>		
<b>#3103</b>	<b>sp_t 3</b>	<b>Acceleration/deceleration time constant with S command (Gear: 10)</b>
<p>Set the acceleration/deceleration time constant with S command (speed operation mode) when gear 10 is selected. Set the linear acceleration/deceleration time up to limit rotation speed (slimit3). Set the short time constant that the motor torque at acceleration is always saturated, however, when an abnormal noise or V-belt slip occurs, increase the time constant.</p> <p><b>---Setting range---</b></p> <p>0 to 30000 (ms)</p>		
<b>#3104</b>	<b>sp_t 4</b>	<b>Acceleration/deceleration time constant with S command (Gear: 11)</b>
<p>Set the acceleration/deceleration time constant with S command (speed operation mode) when gear 11 is selected. Set the linear acceleration/deceleration time up to limit rotation speed (slimit4). Set the short time constant that the motor torque at acceleration is always saturated, however, when an abnormal noise or V-belt slip occurs, increase the time constant.</p> <p><b>---Setting range---</b></p> <p>0 to 30000 (ms)</p>		
<b>#3105</b>	<b>sut</b>	<b>Speed reach range</b>
<p>Set the speed deviation rate with respect to the commanded speed, at which the speed reach signal will be output.</p> <p>It will be 15% when set to "0".</p> <p>If the speed deviation is smaller than 45r/min, it will be set as 45r/min.</p> <p><b>---Setting range---</b></p> <p>0 to 100 (%)</p>		

<b>#3106</b>	<b>zrn_typ</b>	<b>Zero point return specifications</b>
--------------	----------------	---

Select the zero point return specification.

Functions are allocated to each bit.

Set this in hexadecimal format.

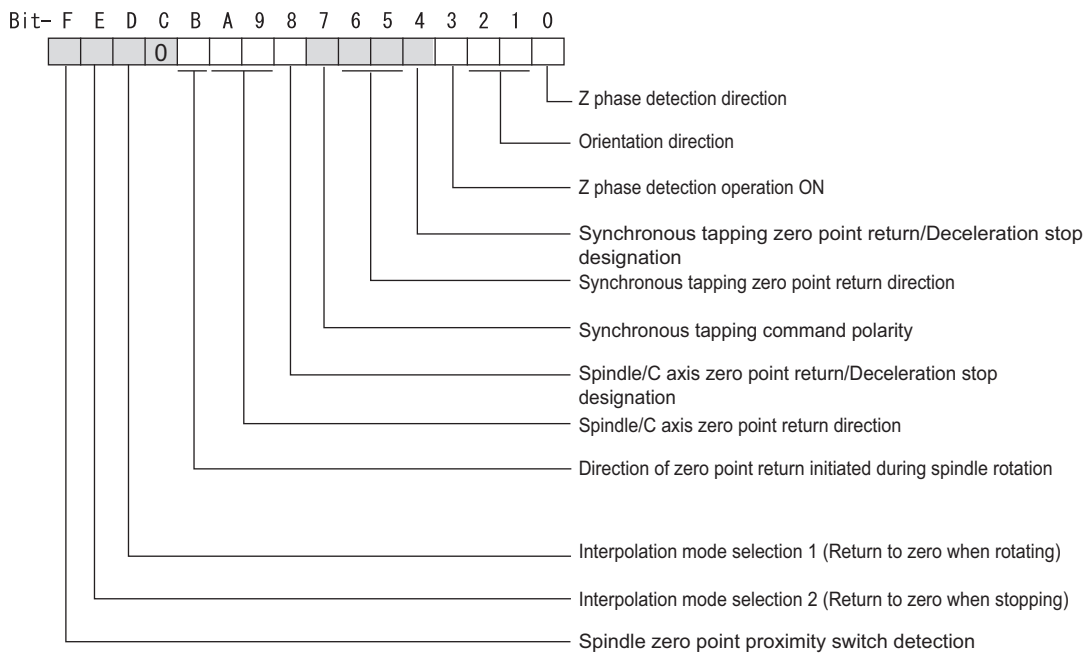

**bitF: Spindle zero point detection with proximity switch**

- 0: Normal
- 1: Enable spindle zero point detection using proximity switch

**bitE: Interpolation mode selection 2 (Return to zero when stopping)**

- 0: Interpolation (Use "#13002 SP002 PGN")
- 1: Non-interpolation (Use "#13001 SP001 PGV")

**bitD: Interpolation mode selection 1 (Return to zero when rotating)**

- 0: Non-interpolation mode
- 1: Interpolation mode

**bitC:**

Not used.

**bitB: Zero return direction spindle rotation**

- 0: Zero return direction
- 1: Spindle rotation direction

**bitA-9: Spindle/C axis zero point return direction**

bitA,9=

- 00: Short-cut
- 01: Forward run
- 10: Reverse run

**bit8: Spindle/C axis zero return or deceleration stop**

- 0: Return to zero
- 1: Decelerate to a stop

**bit7: Synchronous tapping command polarity**

- 0: Forward direction
- 1: Reverse direction (The standard setting when spindle and motor are directly coupled)

**bit6-5: Synchronous tapping zero point return direction**

bit6,5=

- 00: Short-cut
- 01: Forward run
- 10: Reverse run

**bit4: Sync tap zero return or deceleration stop**

- 0: Return to zero
- 1: Decelerate to a stop

**bit3: Phase Z signal detection ON**

- 0: Turn the spindle at a commanded speed and in a signal direction.
- 1: Apply the phase Z detect speed and direction until detection. After that, apply a commanded speed and signal direction.

**bit2-1: Orientation direction**

bit2,1=

- 00: Short-cut
- 01: Forward run
- 10: Reverse run

**bit0: Z phase detection direction**

- 0: Forward direction
- 1: Reverse direction

<b>#3107</b>	<b>ori_spd</b>	<b>Orientation command speed</b>
Set the spindle speed during orientation command.		
When the spindle is not running or running to the different direction with the orientation, the orientation is carried out with this speed after a stop. When the spindle is running to the same direction with the orientation, this parameter does not have a meaning because it decelerates directly and the orientation is carried out.		
<b>---Setting range---</b>		
1 to 99999 (r/min)		
<b>#3108</b>	<b>ori_sft</b>	<b>Position shift amount for orientation</b>
The orientation stop position can be moved by this parameter setting although normally the position is Z-phase position.		
During multi-point orientation control, the stop position is determined by the total value of this parameter and the position data for multi-point orientation of PLC input.		
<b>---Setting range---</b>		
-35999 to 35999 (0.01°)		
<b>#3109</b>	<b>zdetspd</b>	<b>Z phase detection speed</b>
For the first S command after power is turned ON, the spindle rotates at the speed of setting value for this parameter until Z phase is detected twice.		
When "#3106/bitF = 1" (Spindle zero point proximity switch detection enabled), also proximity switch is detected.		
(Note) When spindle zero point proximity switch detection is enabled, the rotation direction of the orientation/zero point return (synchronous tapping, spindle/C axis) will follow Z phase detection direction. And the speed will follow Z phase detection speed.		
<b>---Setting range---</b>		
1 to 99999 (r/min)		
<b>#3110</b>	<b>tap_spd</b>	<b>Synchronous tapping zero point return speed</b>
Set the zero point return speed during synchronous tapping control.		
<b>---Setting range---</b>		
1 to 99999 (r/min)		

<b>#3111</b>	<b>tap_sft</b>	<b>Synchronous tapping zero point return shift amount</b>
Set the zero point return shift amount during synchronous tapping control. Zero point angle shifts from Z phase according to the setting angle.		
<b>---Setting range---</b>		
0 to 35999 (0.01°)		
<b>#3112</b>	<b>cax_spd</b>	<b>Spindle C axis zero point return speed</b>
Set the zero point return speed during spindle C axis control.		
<b>---Setting range---</b>		
1 to 99999 (r/min)		
<b>#3113</b>	<b>cax_sft</b>	<b>Spindle C axis zero point return shift amount</b>
Set the spindle C axis zero point return shift amount. Zero point angle shifts from Z phase according to the setting angle.		
<b>---Setting range---</b>		
0 to 359999 (0.001°)		
<b>#3114</b>	<b>cax_para_chg</b>	<b>Spindle/C axis parameter switch</b>
Parameter switches when switching the encoder system between normal spindle control and C axis control, such as using spindle side encoder only for C axis control in spindle drive system. It is validated with replacing a certain servo parameter of the corresponding servo axis to a spindle parameter.		
0: Not switch		
1: Switch		
<b>---Setting range---</b>		
0/1 (Standard: 0)		
<b>#3115</b>	<b>sp2_t1</b>	<b>Time constant in orientation/interpolation mode automatic reference position return (Gear: 00)</b>
Set the linear acceleration/deceleration time constant for zero point return control (#3106/bit4,8) which is automatically started at the time of switching orientation control, C axis control and synchronous tapping control when gear 00 is selected. The inclination is determined by the ratio to limit rotation speed (slimit1). Set the sufficiently large value compared to the acceleration/deceleration time constant with S command (sp_t1) so that the output torque is not saturated. When executing C axis zero point return manually, it depends on the axis specification parameter.		
<b>---Setting range---</b>		
0 to 30000 (ms)		
<b>#3116</b>	<b>sp2_t2</b>	<b>Time constant in orientation/interpolation mode automatic reference position return (Gear: 01)</b>
Set the linear acceleration/deceleration time constant for zero point return control (#3106/bit4,8) which is automatically started at the time of switching orientation control, C axis control and synchronous tapping control when gear 01 is selected. The inclination is determined by the ratio to limit rotation speed (slimit2). Set the sufficiently large value compared to the acceleration/deceleration time constant with S command (sp_t2) so that the output torque is not saturated. When executing C axis zero point return manually, it depends on the axis specification parameter.		
<b>---Setting range---</b>		
0 to 30000 (ms)		
<b>#3117</b>	<b>sp2_t3</b>	<b>Time constant in orientation/interpolation mode automatic reference position return (Gear: 10)</b>
Set the linear acceleration/deceleration time constant for zero point return control (#3106/bit4,8) which is automatically started at the time of switching orientation control, C axis control and synchronous tapping control when gear 10 is selected. The inclination is determined by the ratio to limit rotation speed (slimit3). Set the sufficiently large value compared to the acceleration/deceleration time constant with S command (sp_t3) so that the output torque is not saturated. When executing C axis zero point return manually, it depends on the axis specification parameter.		
<b>---Setting range---</b>		
0 to 30000 (ms)		

#3118	sp2_t4	<b>Time constant in orientation/interpolation mode automatic reference position return (Gear: 11)</b>
		Set the linear acceleration/deceleration time constant for zero point return control (#3106/bit4,8) which is automatically started at the time of switching orientation control, C axis control and synchronous tapping control when gear 11 is selected. The inclination is determined by the ratio to limit rotation speed (slimit4). Set the sufficiently large value compared to the acceleration/deceleration time constant with S command (sp_t4) so that the output torque is not saturated. When executing C axis zero point return manually, it depends on the axis specification parameter.
		<b>---Setting range---</b> 0 to 30000 (ms)
#3120	staptr	<b>Time constant reduction rate in high-speed synchronous tapping</b>
		When performing high-speed synchronous tapping control(#1281/bit5), set the reduction rate of the time constant compared to the time constant in normal synchronous tapping. (Setting "0" or "100" will be regarded as reduction rate zero, so the time constant won't be reduced.) E.g.) When set to "10", time constant in high-speed synchronous tapping will be 90% of that in normal synchronous tapping.
		<b>---Setting range---</b> 0 to 100 (%)
#3121	tret	<b>Turret indexing</b>
		Select the validity of turret indexing. 0: Disabled 1: Enable
#3122	GRC	<b>Turret side gear ratio</b>
		Set the number of teeth on the turret side when the gear selection command (control input 4/bit6, 5) is set to 00. Set a value of GRC so that the ratio of GRC to the spindle side gear ratio (#13057 SP057) will be 1: N (an integer). If GRC is set to "0", it will be regarded as "1".
		<b>---Setting range---</b> 0 to 32767
#3123	tret_spd	<b>Turret indexing speed</b>
		Set the turret end indexing speed when in turret indexing. When this parameter is set to 0, it follows the value set for Orientation command speed (#3107).
		<b>---Setting range---</b> 0 to 32767(r/min)
#3124	tret_t	<b>Turret indexing time constant</b>
		Set the acceleration/deceleration time constant to reach Limit rotation speed (slimt1) at gear 00 when in turret indexing. Set this parameter to a larger value than time constant in orientation (#3115).
		<b>---Setting range---</b> 0 to 30000 (ms)
#3125	tret_inpos	<b>Turret indexing in-position width</b>
		Set the position error range in which the index positioning complete signal is output when in turret indexing. When this parameter is set to 0, the value of In-position width (#13024 SP024) will be used for this width.
		<b>---Setting range---</b> 0 to 32767(1°/1000)
#3126	tret_fin_off	<b>Index positioning complete signal OFF time</b>
		Set the time to forcibly turn OFF the index positioning complete signal since the indexing start signal turns ON. If this period of time has not passed yet, the index positioning complete signal will not turn ON even at the completion of index positioning.
		<b>---Setting range---</b> 0 to 10000 (ms)

#3127	SPECSP	Spindle specification
		<p><b>bit3: Spindle rotation direction</b></p> <p>Define the relationship between the motor's actual direction of rotation and the spindle rotation signals (Spindle forward run start/Spindle reverse run start).</p> <p>0: Forward direction 1: Reverse direction</p> <p><b>bit1: Spindle cycle counter direction</b></p> <p>Specify whether the cycle counter counts up or down during the spindle forward run.</p> <p>0: Count up during forward run 1: Count down during forward run</p> <p><b>bit0: Output conditions of spindle changeover mode and spindle speed reach signals</b></p> <p>0: Conventional operation</p> <ul style="list-style-type: none"> <li>•Spindle changeover mode signal When the spindle stop signal is ON and when a gear recommended by NC and the one selected in ladder program are different, the spindle changeover mode signal is output to the spindle drive unit.</li> <li>•Spindle speed reach signal Spindle speed reach signal is turn ON/OFF according to the FB signal.</li> </ul> <p>1: Operation when the gear responds to the neutral state under full-closed control</p> <ul style="list-style-type: none"> <li>•Spindle changeover mode signal When both the spindle stop signal and the spindle gear shift signal are ON, the spindle changeover mode signal is output to the spindle drive unit.</li> <li>•Spindle speed reach signal During gear changeover (while gear changeover is being commanded), the spindle speed reach signal is turned ON/OFF according to the virtual spindle-end speed that is calculated by multiplying the motor-end speed by the gear ratio (motor-end gear teeth/spindle-end gear teeth).</li> </ul> <p><b>---Setting range---</b></p> <p>0x0000 to 0xffff (hexadecimal)</p>
#3128	ori_spec	Orientation control specification
		<p><b>bit0: Orientation in-position advance output</b></p> <p>Reduce the orientation time by detecting an in-position faster. The in-position detection width is changed from SP024(#13024) to ori_inp2.</p> <p>0: Disable 1: Enable</p> <p><b>---Setting range---</b></p> <p>0x0000 to 0xffff (hexadecimal)</p>

#3129	cax_spec	Spindle/C axis control specification
		<p><b>bit4: Gain switchover for all the axes within the part system when C axis is selected</b></p> <p>0: The gains of servo axes except C axis are not switched when C axis is selected.  1: The gains of servo axes except C axis are switched when C axis is selected.</p> <p>#2203 (PGN1) SV003 --&gt; #2249 (PGN1sp) SV049  #2204 (PGN2) SV004 --&gt; #2250 (PGN2sp) SV050  #2257 (SHGC) SV057 --&gt; #2258 (SHGCsp) SV058</p> <p><b>bit3: Mode selection at reset when the program command method is selected</b></p> <p>0: Spindle mode  1: The mode at reset is retained.</p> <p>This parameter is enabled when the program command method is selected (#3129 cax_spec/bit0 = 1).</p> <p><b>bit2: Mode selection at Power ON when the program command method is selected</b></p> <p>0: Spindle mode  1: C axis mode</p> <p>This parameter is enabled when the program command method is selected (#3129 cax_spec/bit0 = 1).</p> <p><b>bit1: Coordinate system setting when the deceleration stop type (no zero point return) is selected</b></p> <p>Select the C axis coordinate system setting method when the deceleration stop type (no zero point return) is selected.</p> <p>0: Establish the coordinates of the deceleration stop position by using the Z-phase position as the coordinate zero point.  1: The deceleration stop position is used as the coordinate zero point.</p> <p><b>bit0: Spindle position control changeover method</b></p> <p>Select the method of changing the mode between C axis and spindle.</p> <p>0: PLC signal method  1: Program command method</p> <p>---Setting range---  0x0000 to 0xffff (hexadecimal)</p>
#3130	syn_spec	Spindle synchronization control specification
		<p><b>bit2: Error compensation between reference and synchronized spindles</b></p> <p>0: Error compensation is performed.  1: Error compensation is not performed.</p> <p>(*) Set this parameter for the synchronized spindle.</p> <p><b>bit1: Phase alignment method selection</b></p> <p>0: Phase alignment method type 1 (step alignment method)  1: Phase alignment method type 2 (multi-step acceleration/deceleration method)</p> <p>(*) Set this parameter for the synchronized spindle.</p> <p><b>bit0: Tool spindle synchronization II (hobbing) automatic compensation selection</b></p> <p>0: No compensation.  1: Compensate hobbing axis delay (advance) with workpiece axis.</p> <p>---Setting range---  0x0000 to 0xffff (hexadecimal)</p>
#3131	tap_spec	Synchronous tapping control specification
		Not used. Set to "0000".
#3132	ori_inp2	2nd in-position width for orientation
		<p>Set the in-position width when in-position advance output control (#3128/bit0) is valid. Reduce the orientation time by setting a bigger value than the value of conventional SP024 and detecting an in-position faster. Conventional SP024 is used for 2nd in-position signal detection width.</p> <p>---Setting range---  0 to 32767 (1deg/1000)</p>

	<b>#3133</b>	<b>spherr</b>	<b>Hobbing axis delay (advance) allowable angle</b>
			Set the allowable angle between the commanded position and actual position of hobbing axis when it is in tool spindle synchronization II (hobbing) mode (X18AE ON), and also when hobbing axis and workpiece axis are synchronizing (X18A9 ON).
			<b>---Setting range---</b>
			0 to 32767 (1deg/1000)
	<b>#3134</b>	<b>sphtc</b>	<b>Primary delay time constant for hobbing axis automatic compensation</b>
			Set the primary delay time constant of hobbing axis automatic compensation primary delay filter control in tool spindle synchronization II (hobbing).
			When set to "0", primary delay filter control is invalid.
			<b>---Setting range---</b>
			0 to 32767 (ms)
	<b>#3135</b>	<b>sfwd_g</b>	<b>Feed forward gain for hobbing axis</b>
			Set the feed forward gain for the hobbing axis in tool spindle synchronization II (hobbing) mode.
			<b>---Setting range---</b>
			0 to 200 (%)
	<b>#3137</b>	<b>stap_ax_off</b>	<b>High-speed synchronous tapping disabled axis</b>
			Not used. Set to "0".
	<b>#3138</b>	<b>motor_type</b>	<b>Spindle motor type</b>
			Set the spindle motor type. The set type will be displayed on the drive monitor screen, and it will be also output to the system configuration data.
			<b>---Setting range---</b>
			Character string within 26 characters including A-Z, a-z, 0-9, "." (decimal point), "-" (hyphen), "/" (slash) (Setting is cleared when "0" is set)
<b>(PR)</b>	<b>#3139</b>	<b>sp_srvdrv</b>	<b>Spindle-mode servo control</b>
			Select whether to enable spindle control using a servo drive unit and servo motor (spindle-mode servo control).
			0: Disable spindle-mode servo control 1: Enable spindle-mode servo control
<b>(PR)</b>	<b>#3140</b>	<b>S_DINSp</b>	<b>Speed observation input door No.</b>
			Set the door signal input in the drive unit.
			Use this parameter only when the axis with a door signal belongs to several door groups.
			The correspondence between the door signals and bits are as follows.
			bit0: Door1 signal
			bit1: Door2 signal
			If the axis does not receive any door signal, set to "0".
			An error (Y20 0027) will occur in the following cases.
			- Several bits are enabled.
			- Any bit other than those set in "#3071 S_DSISp" is enabled.
			<b>---Setting range---</b>
			0000 to 0002 (HEX)
<b>(PR)</b>	<b>#3141</b>	<b>spsscfeed1</b>	<b>Observation speed 1</b>
			Not used.
<b>(PR)</b>	<b>#3142</b>	<b>spsscfeed2</b>	<b>Observation speed 2</b>
			Not used.
<b>(PR)</b>	<b>#3143</b>	<b>spsscfeed3</b>	<b>Observation speed 3</b>
			Not used.
<b>(PR)</b>	<b>#3144</b>	<b>spsscfeed4</b>	<b>Observation speed 4</b>
			Not used.
<b>(PR)</b>	<b>#3145</b>	<b>S_SigInSP</b>	<b>Safety observation signal input</b>
			Not used.



#3146	<b>RatedOutL(PwrCal)</b>	<b>Short-time rated output for power computation (L-coil)</b>	
Specify the short-time rated output of the spindle motor (for L-coil). This value is used for calculating the power consumption of the spindle motor.			
---Setting range---			
0 to 99999999 (W)			
#3147	<b>RatedOutH(PwrCal)</b>	<b>Short-time rated output for power computation (H-coil)</b>	
Specify the short-time rated output of the spindle motor (for H-coil). This value is used for calculating the power consumption of the spindle motor. This parameter is used also when the coil switch function is OFF.			
---Setting range---			
0 to 99999999 (W)			
#3148	<b>syncmctm</b>	<b>Temporary error cancel calculation delay time</b>	
When a period of time set in this parameter has elapsed after turning-ON of the spindle chuck close (SPC-MPC) signal, you can temporarily cancel spindle sync error by turning ON the spindle sync error temporary cancel (SPDRPO) signal. If the specified time has not elapsed when the spindle sync error temporary cancel (SPDRPO) signal is turned ON, temporary cancel of spindle sync error is enabled first when the time of this parameter has elapsed. When "0" is set in this parameter, the delay time will be 284 (ms).			
---Setting range---			
0 to 30000 (ms)			
(PR)	#3149	<b>spsscfeed5</b>	<b>Observation speed 5</b>
Not used.			
(PR)	#3150	<b>spsscfeed6</b>	<b>Observation speed 6</b>
Not used.			
(PR)	#3151	<b>spsscfeed7</b>	<b>Observation speed 7</b>
Not used.			
(PR)	#3152	<b>spsscfeed8</b>	<b>Observation speed 8</b>
Not used.			
#3153	<b>cms1</b>	<b>Spindle viscous friction coefficient 1</b>	
Set a viscous friction coefficient for spindle. This parameter is to estimate the cutting torque of spindle. #13018(SP018)/bit5=0: Mechanical gear 1-step #13018(SP018)/bit5=1: Coil changeover H			
---Setting range---			
0 to ± 9999999 (0.00001%/rpm)			
#3154	<b>cms2</b>	<b>Spindle viscous friction coefficient 2</b>	
Set a viscous friction coefficient for spindle. This parameter is to estimate the cutting torque of spindle. #13018(SP018)/bit5=0: Mechanical gear 2-step #13018(SP018)/bit5=1: Coil changeover L			
---Setting range---			
0 to ± 9999999 (0.00001%/rpm)			
#3155	<b>cms3</b>	<b>Spindle viscous friction coefficient 3</b>	
Set a viscous friction coefficient for spindle. This parameter is to estimate the cutting torque of spindle. #13018(SP018)/bit5=0: Mechanical gear 3-step #13018(SP018)/bit5=1: Coil changeover Not use			
---Setting range---			
0 to ± 9999999 (0.00001%/rpm)			

<b>#3156</b>	<b>cms4</b>	<b>Spindle viscous friction coefficient 4</b>
Set a viscous friction coefficient for spindle. This parameter is to estimate the cutting torque of spindle. #13018(SP018)/bit5=0: Mechanical gear 4-step #13018(SP018)/bit5=1: Coil changeover Not use <b>---Setting range---</b> 0 to ± 9999999 (0.00001%/rpm)		
<b>#3157</b>	<b>fms1</b>	<b>Spindle coulomb friction coefficient 1</b>
Set a coulomb friction coefficient for spindle. This parameter is to estimate the cutting torque of spindle. #13018(SP018)/bit5=0: Mechanical gear 1-step #13018(SP018)/bit5=1: Coil changeover H <b>---Setting range---</b> 0 to ± 9999999 (0.0001%/Nm)		
<b>#3158</b>	<b>fms2</b>	<b>Spindle coulomb friction coefficient 2</b>
Set a coulomb friction coefficient for spindle. This parameter is to estimate the cutting torque of spindle. #13018(SP018)/bit5=0: Mechanical gear 2-step #13018(SP018)/bit5=1: Coil changeover L <b>---Setting range---</b> 0 to ± 9999999 (0.0001%/Nm)		
<b>#3159</b>	<b>fms3</b>	<b>Spindle coulomb friction coefficient 3</b>
Set a coulomb friction coefficient for spindle. This parameter is to estimate the cutting torque of spindle. #13018(SP018)/bit5=0: Mechanical gear 3-step #13018(SP018)/bit5=1: Coil changeover Not use <b>---Setting range---</b> 0 to ± 9999999 (0.0001%/Nm)		
<b>#3160</b>	<b>fms4</b>	<b>Spindle coulomb friction coefficient 4</b>
Set a coulomb friction coefficient for spindle. This parameter is to estimate the cutting torque of spindle. #13018(SP018)/bit5=0: Mechanical gear 4-step #13018(SP018)/bit5=1: Coil changeover Not use <b>---Setting range---</b> 0 to ± 9999999 (0.0001%/Nm)		
<b>#3166</b>	<b>disttrq_t</b>	<b>Disturbance torque detection filter time constant</b>
Set the responsiveness in detecting the disturbance torque. <b>---Setting range---</b> 0 to 1000 (ms) (Default value: 0)		
<b>#3168</b>	<b>StlTrqSPSV(PwrCal)</b>	<b>Stall torque of spindle-mode servo motor for power computation</b>
Specify the stall torque of spindle-mode servo motor. This value is used for calculating the power consumption of the spindle-mode servo motor. <b>---Setting range---</b> 0.000 to 1000.000 (Nm)		
<b>#3169</b>	<b>rotspszp</b>	<b>Spindle-mode rotary axis Motor zero speed (For spindle-mode rotary axis only)</b>
Not used.		
<b>#3170</b>	<b>rotspsdts</b>	<b>Spindle-mode rotary axis Speed detection setting value (For spindle-mode rotary axis only)</b>
Not used.		

(PR)	#3192	LdMeter thresholdY	Loadmeter: Caution (Yellow) threshold
		Specify the spindle load (%) at which the loadmeter displays a caution sign (yellow). If spindle load exceeds the specified value, the loadmeter displays a caution (yellow).  If you wish to avoid showing the caution (yellow), set this parameter to be the same as "#3193 LdMeter thresholdR".  When "0" is set, the value becomes 100% (default).	
		---Setting range---	
		0 to 300(%)	
(PR)	#3193	LdMeter thresholdR	Loadmeter: Warning (Red) threshold
		Specify the spindle load (%) at which the loadmeter displays a warning sign (red). If spindle load exceeds the specified value, the loadmeter displays a warning (red). If you wish to avoid showing the warning (red), set this parameter to be the same as "#3194 LdMeter load max".  When "0" is set, the value becomes 150% (default).	
		---Setting range---	
		0 to 300(%)	
(PR)	#3194	LdMeter load max	Loadmeter: Maximum spindle load
		Specify the maximum spindle load (%) for loadmeter display. When "0" is set, the value becomes 200% (default).	
		---Setting range---	
		0 to 300(%)	
(PR)	#3195	mgrsptyp	Spindle's machine group setting type
		Specify which of the spindle's machine group No. parameters to use for the machine groupwise alarm stop function.  0: "#3196 mgrspnum1" (Spindle's machine group No. 1) 1: "#3197 mgrspnum2" (Spindle's machine group No. 2)	
(PR)	#3196	mgrspnum1	Spindle's machine group No. 1
		Specify the machine group No. to which each spindle belongs. This parameter is enabled when the parameter "#3195 mgrsptyp" (Spindle's machine group setting type) is set to "0".	
		---Setting range---	
		0 to 32	
(PR)	#3197	mgrspnum2	Spindle's machine group No. 2
		Specify the machine group No. to which each spindle belongs, by setting the corresponding bit. This parameter is enabled when the parameter "#3195 mgrsptyp" (Spindle's machine group setting type) is set to "1".	
		---Setting range---	
		00 to FF Set this in hexadecimal format.	
	#13501	vfths11	Variable speed thread multi-step accel/decel change-over speed 1 (Gear00)
		Set the spindle speed for changing the 1st step's acceleration/deceleration time constant at gear 00.	
		---Setting range---	
		0 to 99999 (r/min)	
	#13502	vfths12	Variable speed thread multi-step accel/decel change-over speed 1 (Gear01)
		Set the spindle speed for changing the 1st step's acceleration/deceleration time constant at gear 01.	
		---Setting range---	
		0 to 99999 (r/min)	

#13503	vfths13	Variable speed thread multi-step accel/decel change-over speed 1 (Gear10)
Set the spindle speed for changing the 1st step's acceleration/deceleration time constant at gear 10.		
---Setting range---		
0 to 99999 (r/min)		
#13504	vfths14	Variable speed thread multi-step accel/decel change-over speed 1 (Gear11)
Set the spindle speed for changing the 1st step's acceleration/deceleration time constant at gear 11.		
---Setting range---		
0 to 99999 (r/min)		
#13505	vftht11	Variable speed thread multi-step accel/decel change time constant 1 (Gear00)
Set the time constant to reach the variable speed thread multi-step acceleration/deceleration changeover speed 1 at gear 00.		
---Setting range---		
0 to 30000 (10 ms)		
#13506	vftht12	Variable speed thread multi-step accel/decel change time constant 1 (Gear01)
Set the time constant to reach the variable speed thread multi-step acceleration/deceleration changeover speed 1 at gear 01.		
---Setting range---		
0 to 30000 (10 ms)		
#13507	vftht13	Variable speed thread multi-step accel/decel change time constant 1 (Gear10)
Set the time constant to reach the variable speed thread multi-step acceleration/deceleration changeover speed 1 at gear 10.		
---Setting range---		
0 to 30000 (10 ms)		
#13508	vftht14	Variable speed thread multi-step accel/decel change time constant 1 (Gear11)
Set the time constant to reach the variable speed thread multi-step acceleration/deceleration changeover speed 1 at gear 11.		
---Setting range---		
0 to 30000 (10 ms)		
#13509	vfths21	Variable speed thread multi-step accel/decel change-over speed 2 (Gear00)
Set the spindle speed for changing the 2nd step's acceleration/deceleration time constant at gear 00.		
---Setting range---		
0 to 99999 (r/min)		
#13510	vfths22	Variable speed thread multi-step accel/decel change-over speed 2 (Gear01)
Set the spindle speed for changing the 2nd step's acceleration/deceleration time constant at gear 01.		
---Setting range---		
0 to 99999 (r/min)		
#13511	vfths23	Variable speed thread multi-step accel/decel change-over speed 2 (Gear10)
Set the spindle speed for changing the 2nd step's acceleration/deceleration time constant at gear 10.		
---Setting range---		
0 to 99999 (r/min)		

#13512	vfths24	Variable speed thread multi-step accel/decel change-over speed 2 (Gear11)
Set the spindle speed for changing the 2nd step's acceleration/deceleration time constant at gear 11.		
---Setting range---		
0 to 99999 (r/min)		
#13513	vftht21	Variable speed thread multi-step accel/decel change time constant 2 (Gear00)
Set the time constant to reach the variable speed thread multi-step acceleration/deceleration changeover speed 2 at gear 00.		
---Setting range---		
0 to 30000 (10 ms)		
#13514	vftht22	Variable speed thread multi-step accel/decel change time constant 2 (Gear01)
Set the time constant to reach the variable speed thread multi-step acceleration/deceleration changeover speed 2 at gear 01.		
---Setting range---		
0 to 30000 (10 ms)		
#13515	vftht23	Variable speed thread multi-step accel/decel change time constant 2 (Gear10)
Set the time constant to reach the variable speed thread multi-step acceleration/deceleration changeover speed 2 at gear 10.		
---Setting range---		
0 to 30000 (10 ms)		
#13516	vftht24	Variable speed thread multi-step accel/decel change time constant 2 (Gear11)
Set the time constant to reach the variable speed thread multi-step acceleration/deceleration changeover speed 2 at gear 11.		
---Setting range---		
0 to 30000 (10 ms)		
#13517	vftht31	Variable speed thread multi-step accel/decel change time constant 3 (Gear00)
Set the time constant to reach the limit rotation speed at gear 00.		
---Setting range---		
0 to 30000 (10 ms)		
#13518	vftht32	Variable speed thread multi-step accel/decel change time constant 3 (Gear01)
Set the time constant to reach the limit rotation speed at gear 01.		
---Setting range---		
0 to 30000 (10 ms)		
#13519	vftht33	Variable speed thread multi-step accel/decel change time constant 3 (Gear10)
Set the time constant to reach the limit rotation speed at gear 10.		
---Setting range---		
0 to 30000 (10 ms)		
#13520	vftht34	Variable speed thread multi-step accel/decel change time constant 3 (Gear11)
Set the time constant to reach the limit rotation speed at gear 11.		
---Setting range---		
0 to 30000 (10 ms)		

#13521	spt2	<b>Spindle synchronization acceleration/deceleration time constant (Gear: 01)</b>
<p>Spindle synchronization acceleration/deceleration time constant (Gear: 01) Specify the acceleration/deceleration time constant to be used when the rotation speed of spindle synchronization command is changed with the 2nd gear selected under the spindle-mode servo control or spindle synchronization control.</p> <p>---Setting range--- 0 to 9999(ms)</p>		
#13522	sptc21	<b>Spindle sync multistep acceleration/deceleration changeover speed 1 (Gear: 01)</b>
<p>Specify the spindle speed at which a changeover to the 1st step's acceleration/deceleration time constant is made when the 2nd step gear is selected.</p> <p>---Setting range--- 0 to 99999 (r/min)</p>		
#13523	sptc22	<b>Spindle sync multistep acceleration/deceleration changeover speed 2 (Gear: 01)</b>
<p>Specify the spindle speed at which a changeover to the 2nd step's acceleration/deceleration time constant is made when the 2nd step gear is selected.</p> <p>---Setting range--- 0 to 99999 (r/min)</p>		
#13524	sptc23	<b>Spindle sync multistep acceleration/deceleration changeover speed 3 (Gear: 01)</b>
<p>Specify the spindle speed at which a changeover to the 3rd step's acceleration/deceleration time constant is made when the 2nd step gear is selected.</p> <p>---Setting range--- 0 to 99999 (r/min)</p>		
#13525	sptc24	<b>Spindle sync multistep acceleration/deceleration changeover speed 4 (Gear: 01)</b>
<p>Specify the spindle speed at which a changeover to the 4th step's acceleration/deceleration time constant is made when the 2nd step gear is selected.</p> <p>---Setting range--- 0 to 99999 (r/min)</p>		
#13526	sptc25	<b>Spindle sync multistep acceleration/deceleration changeover speed 5 (Gear: 01)</b>
<p>Specify the spindle speed at which a changeover to the 5th step's acceleration/deceleration time constant is made when the 2nd step gear is selected.</p> <p>---Setting range--- 0 to 99999 (r/min)</p>		
#13527	sptc26	<b>Spindle sync multistep acceleration/deceleration changeover speed 6 (Gear: 01)</b>
<p>Specify the spindle speed at which a changeover to the 6th step's acceleration/deceleration time constant is made when the 2nd step gear is selected.</p> <p>---Setting range--- 0 to 99999 (r/min)</p>		
#13528	sptc27	<b>Spindle sync multistep acceleration/deceleration changeover speed 7 (Gear: 01)</b>
<p>Specify the spindle speed at which a changeover to the 7th step's acceleration/deceleration time constant is made when the 2nd step gear is selected.</p> <p>---Setting range--- 0 to 99999 (r/min)</p>		

<b>#13529</b>	<b>spdiv21</b>	<b>Time constant magnification for changeover speed 1 (Gear: 01)</b>
<p>Time constant magnification for changeover speed 1 (Gear: 01) Specify the acceleration/deceleration time constant to be used in a range of the spindle-mode servo control/spindle synchronization multi-step acceleration/deceleration changeover speed 1 (sptc21) to the spindle sync multi-step acceleration/deceleration changeover speed 2 (sptc22) when the 2nd step gear is selected. Set this as a magnification with respect to the spindle-mode servo control/spindle synchronization acceleration/deceleration time constant (spt2).</p> <p><b>---Setting range---</b> 0 to 127</p>		
<b>#13530</b>	<b>spdiv22</b>	<b>Time constant magnification for changeover speed 2 (Gear: 01)</b>
<p>Time constant magnification for changeover speed 2 (Gear: 01) Specify the acceleration/deceleration time constant to be used in a range of the spindle-mode servo control/spindle synchronization multi-step acceleration/deceleration changeover speed 2 (sptc22) to the spindle sync multi-step acceleration/deceleration changeover speed 3 (sptc23) when the 2nd step gear is selected. Set this as a magnification with respect to the spindle-mode servo control/spindle synchronization acceleration/deceleration time constant (spt2).</p> <p><b>---Setting range---</b> 0 to 127</p>		
<b>#13531</b>	<b>spdiv23</b>	<b>Time constant magnification for changeover speed 3 (Gear: 01)</b>
<p>Time constant magnification for changeover speed 3 (Gear: 01) Specify the acceleration/deceleration time constant to be used in a range of the spindle-mode servo control/spindle synchronization multi-step acceleration/deceleration changeover speed 3 (sptc23) to the spindle sync multi-step acceleration/deceleration changeover speed 4 (sptc24) when the 2nd step gear is selected. Set this as a magnification with respect to the spindle-mode servo control/spindle synchronization acceleration/deceleration time constant (spt2).</p> <p><b>---Setting range---</b> 0 to 127</p>		
<b>#13532</b>	<b>spdiv24</b>	<b>Time constant magnification for changeover speed 4 (Gear: 01)</b>
<p>Time constant magnification for changeover speed 4 (Gear: 01) Specify the acceleration/deceleration time constant to be used in a range of the spindle-mode servo control/spindle synchronization multi-step acceleration/deceleration changeover speed 4 (sptc24) to the spindle sync multi-step acceleration/deceleration changeover speed 5 (sptc25) when the 2nd step gear is selected. Set this as a magnification with respect to the spindle-mode servo control/spindle synchronization acceleration/deceleration time constant (spt2).</p> <p><b>---Setting range---</b> 0 to 127</p>		
<b>#13533</b>	<b>spdiv25</b>	<b>Time constant magnification for changeover speed 5 (Gear: 01)</b>
<p>Time constant magnification for changeover speed 5 (Gear: 01) Specify the acceleration/deceleration time constant to be used in a range of the spindle-mode servo control/spindle synchronization multi-step acceleration/deceleration changeover speed 5 (sptc25) to the spindle sync multi-step acceleration/deceleration changeover speed 6 (sptc26) when the 2nd step gear is selected. Set this as a magnification with respect to the spindle-mode servo control/spindle synchronization acceleration/deceleration time constant (spt2).</p> <p><b>---Setting range---</b> 0 to 127</p>		

#13534	spdiv26	<b>Time constant magnification for changeover speed 6 (Gear: 01)</b>
<p>Time constant magnification for changeover speed 6 (Gear: 01) Specify the acceleration/deceleration time constant to be used in a range of the spindle-mode servo control/spindle synchronization multi-step acceleration/deceleration changeover speed 6 (sptc26) to the spindle sync multi-step acceleration/deceleration changeover speed 7 (sptc27) when the 2nd step gear is selected. Set this as a magnification with respect to the spindle-mode servo control/spindle synchronization acceleration/deceleration time constant (spt2).</p> <p><b>---Setting range---</b> 0 to 127</p>		
#13535	spdiv27	<b>Time constant magnification for changeover speed 7 (Gear: 01)</b>
<p>Time constant magnification for changeover speed 7 (Gear: 01) Specify the acceleration/deceleration time constant to be used for the spindle-mode servo control/spindle synchronization multi-step acceleration/deceleration changeover speed 7 (sptc27) or a higher speed when the 2nd step gear is selected. Set this as a magnification with respect to the spindle-mode servo control/spindle synchronization acceleration/deceleration time constant (spt2).</p> <p><b>---Setting range---</b> 0 to 127</p>		
#13536	spt3	<b>Spindle synchronization acceleration/deceleration time constant(Gear: 10)</b>
<p>Spindle synchronization acceleration/deceleration time constant(Gear: 10) Specify the acceleration/deceleration time constant to be used when the commanded spindle synchronization rotation speed is changed with the 3rd gear selected during the spindle-mode servo control or spindle synchronization control.</p> <p><b>---Setting range---</b> 0 to 9999(ms)</p>		
#13537	sptc31	<b>Spindle sync multistep acceleration/deceleration changeover speed 1 (Gear: 10)</b>
<p>Specify the spindle speed at which a changeover to the 1st step's acceleration/deceleration time constant is made when the 3rd step gear is selected.</p> <p><b>---Setting range---</b> 0 to 99999 (r/min)</p>		
#13538	sptc32	<b>Spindle sync multistep acceleration/deceleration changeover speed 2 (Gear: 10)</b>
<p>Specify the spindle speed at which a changeover to the 2nd step's acceleration/deceleration time constant is made when the 3rd step gear is selected.</p> <p><b>---Setting range---</b> 0 to 99999 (r/min)</p>		
#13539	sptc33	<b>Spindle sync multistep acceleration/deceleration changeover speed 3 (Gear: 10)</b>
<p>Specify the spindle speed at which a changeover to the 3rd step's acceleration/deceleration time constant is made when the 3rd step gear is selected.</p> <p><b>---Setting range---</b> 0 to 99999 (r/min)</p>		
#13540	sptc34	<b>Spindle sync multistep acceleration/deceleration changeover speed 4 (Gear: 10)</b>
<p>Specify the spindle speed at which a changeover to the 4th step's acceleration/deceleration time constant is made when the 3rd step gear is selected.</p> <p><b>---Setting range---</b> 0 to 99999 (r/min)</p>		



<b>#13541</b>	<b>sptc35</b>	<b>Spindle sync multistep acceleration/deceleration changeover speed 5 (Gear: 10)</b>
Specify the spindle speed at which a changeover to the 5th step's acceleration/deceleration time constant is made when the 3rd step gear is selected.		
---Setting range---		
0 to 99999 (r/min)		
<b>#13542</b>	<b>sptc36</b>	<b>Spindle sync multistep acceleration/deceleration changeover speed 6 (Gear: 10)</b>
Specify the spindle speed at which a changeover to the 6th step's acceleration/deceleration time constant is made when the 3rd step gear is selected.		
---Setting range---		
0 to 99999 (r/min)		
<b>#13543</b>	<b>sptc37</b>	<b>Spindle sync multistep acceleration/deceleration changeover speed 7 (Gear: 10)</b>
Specify the spindle speed at which a changeover to the 7th step's acceleration/deceleration time constant is made when the 3rd step gear is selected.		
---Setting range---		
0 to 99999 (r/min)		
<b>#13544</b>	<b>spdiv31</b>	<b>Time constant magnification for changeover speed 1 (Gear: 10)</b>
Time constant magnification for changeover speed 1 (Gear: 10) Specify the acceleration/deceleration time constant to be used in a range of the spindle-mode servo control/spindle synchronization multi-step acceleration/deceleration changeover speed 1 (sptc31) to the spindle sync multi-step acceleration/deceleration changeover speed 2 (sptc32) when the 3rd step gear is selected. Set this as a magnification with respect to the spindle-mode servo control/spindle synchronization acceleration/deceleration time constant (spt3).		
---Setting range---		
0 to 127		
<b>#13545</b>	<b>spdiv32</b>	<b>Time constant magnification for changeover speed 2 (Gear: 10)</b>
Time constant magnification for changeover speed 2 (Gear: 10) Specify the acceleration/deceleration time constant to be used in a range of the spindle-mode servo control/spindle synchronization multi-step acceleration/deceleration changeover speed 2 (sptc32) to the spindle sync multi-step acceleration/deceleration changeover speed 3 (sptc33) when the 3rd step gear is selected. Set this as a magnification with respect to the spindle-mode servo control/spindle synchronization acceleration/deceleration time constant (spt3).		
---Setting range---		
0 to 127		
<b>#13546</b>	<b>spdiv33</b>	<b>Time constant magnification for changeover speed 3 (Gear: 10)</b>
Time constant magnification for changeover speed 3 (Gear: 10) Specify the acceleration/deceleration time constant to be used in a range of the spindle-mode servo control/spindle synchronization multi-step acceleration/deceleration changeover speed 3 (sptc33) to the spindle sync multi-step acceleration/deceleration changeover speed 4 (sptc34) when the 3rd step gear is selected. Set this as a magnification with respect to the spindle-mode servo control/spindle synchronization acceleration/deceleration time constant (spt3).		
---Setting range---		
0 to 127		

<b>#13547</b>	<b>spdiv34</b>	<b>Time constant magnification for changeover speed 4 (Gear: 10)</b>
<p>Time constant magnification for changeover speed 4 (Gear: 10) Specify the acceleration/deceleration time constant to be used in a range of the spindle-mode servo control/spindle synchronization multi-step acceleration/deceleration changeover speed 4 (sptc34) to the spindle sync multi-step acceleration/deceleration changeover speed 5 (sptc35) when the 3rd step gear is selected. Set this as a magnification with respect to the spindle-mode servo control/spindle synchronization acceleration/deceleration time constant (spt3).</p> <p><b>---Setting range---</b> 0 to 127</p>		
<b>#13548</b>	<b>spdiv35</b>	<b>Time constant magnification for changeover speed 5 (Gear: 10)</b>
<p>Time constant magnification for changeover speed 5 (Gear: 10) Specify the acceleration/deceleration time constant to be used in a range of the spindle-mode servo control/spindle synchronization multi-step acceleration/deceleration changeover speed 5 (sptc35) to the spindle sync multi-step acceleration/deceleration changeover speed 6 (sptc36) when the 3rd step gear is selected. Set this as a magnification with respect to the spindle-mode servo control/spindle synchronization acceleration/deceleration time constant (spt3).</p> <p><b>---Setting range---</b> 0 to 127</p>		
<b>#13549</b>	<b>spdiv36</b>	<b>Time constant magnification for changeover speed 6 (Gear: 10)</b>
<p>Time constant magnification for changeover speed 6 (Gear: 10) Specify the acceleration/deceleration time constant to be used in a range of the spindle-mode servo control/spindle synchronization multi-step acceleration/deceleration changeover speed 6 (sptc36) to the spindle sync multi-step acceleration/deceleration changeover speed 7 (sptc37) when the 3rd step gear is selected. Set this as a magnification with respect to the spindle-mode servo control/spindle synchronization acceleration/deceleration time constant (spt3).</p> <p><b>---Setting range---</b> 0 to 127</p>		
<b>#13550</b>	<b>spdiv37</b>	<b>Time constant magnification for changeover speed 7 (Gear: 10)</b>
<p>Time constant magnification for changeover speed 7 (Gear: 10) Specify the acceleration/deceleration time constant to be used for the spindle-mode servo control/spindle synchronization multi-step acceleration/deceleration changeover speed 7 (sptc37) or a higher speed when the 3rd step gear is selected. Set this as a magnification with respect to the spindle-mode servo control/spindle synchronization acceleration/deceleration time constant (spt3).</p> <p><b>---Setting range---</b> 0 to 127</p>		
<b>#13551</b>	<b>spt4</b>	<b>Spindle synchronization acceleration/deceleration time constant (Gear: 11)</b>
<p>Spindle synchronization acceleration/deceleration time constant (Gear: 11) Specify the acceleration/deceleration time constant to be used when the commanded spindle synchronization rotation speed is changed with the 4th gear selected during the spindle-mode servo control or spindle synchronization control.</p> <p><b>---Setting range---</b> 0 to 9999(ms)</p>		
<b>#13552</b>	<b>sptc41</b>	<b>Spindle sync multistep acceleration/deceleration changeover speed 1 (Gear: 11)</b>
<p>Specify the spindle speed at which a changeover to the 1st step's acceleration/deceleration time constant is made when the 4th step gear is selected.</p> <p><b>---Setting range---</b> 0 to 99999 (r/min)</p>		

<b>#13553</b>	<b>sptc42</b>	<b>Spindle sync multistep acceleration/deceleration changeover speed 2 (Gear: 11)</b>
Specify the spindle speed at which a changeover to the 2nd step's acceleration/deceleration time constant is made when the 4th step gear is selected.		
---Setting range---		
0 to 99999 (r/min)		
<b>#13554</b>	<b>sptc43</b>	<b>Spindle sync multistep acceleration/deceleration changeover speed 3 (Gear: 11)</b>
Specify the spindle speed at which a changeover to the 3rd step's acceleration/deceleration time constant is made when the 4th step gear is selected.		
---Setting range---		
0 to 99999 (r/min)		
<b>#13555</b>	<b>sptc44</b>	<b>Spindle sync multistep acceleration/deceleration changeover speed 4 (Gear: 11)</b>
Specify the spindle speed at which a changeover to the 4th step's acceleration/deceleration time constant is made when the 4th step gear is selected.		
---Setting range---		
0 to 99999 (r/min)		
<b>#13556</b>	<b>sptc45</b>	<b>Spindle sync multistep acceleration/deceleration changeover speed 5 (Gear: 11)</b>
Specify the spindle speed at which a changeover to the 5th step's acceleration/deceleration time constant is made when the 4th step gear is selected.		
---Setting range---		
0 to 99999 (r/min)		
<b>#13557</b>	<b>sptc46</b>	<b>Spindle sync multistep acceleration/deceleration changeover speed 6 (Gear: 11)</b>
Specify the spindle speed at which a changeover to the 6th step's acceleration/deceleration time constant is made when the 4th step gear is selected.		
---Setting range---		
0 to 99999 (r/min)		
<b>#13558</b>	<b>sptc47</b>	<b>Spindle sync multistep acceleration/deceleration changeover speed 7 (Gear: 11)</b>
Specify the spindle speed at which a changeover to the 7th step's acceleration/deceleration time constant is made when the 4th step gear is selected.		
---Setting range---		
0 to 99999 (r/min)		
<b>#13559</b>	<b>sptdiv41</b>	<b>Time constant magnification for changeover speed 1 (Gear: 11)</b>
Time constant magnification for changeover speed 1 (Gear: 11)		
Specify the acceleration/deceleration time constant to be used in a range of the spindle-mode servo control/spindle synchronization multi-step acceleration/deceleration changeover speed 1 (sptc41) to the spindle sync multi-step acceleration/deceleration changeover speed 2 (sptc42) when the 4th step gear is selected. Set this as a magnification with respect to the spindle-mode servo control/spindle synchronization acceleration/deceleration time constant (spt4).		
---Setting range---		
0 to 127		

<b>#13560</b>	<b>spdiv42</b>	<b>Time constant magnification for changeover speed 2 (Gear: 11)</b>
<p>Time constant magnification for changeover speed 2 (Gear: 11)</p> <p>Specify the acceleration/deceleration time constant to be used in a range of the spindle-mode servo control/spindle synchronization multi-step acceleration/deceleration changeover speed 2 (sptc42) to the spindle sync multi-step acceleration/deceleration changeover speed 3 (sptc43) when the 4th step gear is selected. Set this as a magnification with respect to the spindle-mode servo control/spindle synchronization acceleration/deceleration time constant (spt4).</p> <p><b>---Setting range---</b></p> <p>0 to 127</p>		
<b>#13561</b>	<b>spdiv43</b>	<b>Time constant magnification for changeover speed 3 (Gear: 11)</b>
<p>Time constant magnification for changeover speed 3 (Gear: 11)</p> <p>Specify the acceleration/deceleration time constant to be used in a range of the spindle-mode servo control/spindle synchronization multi-step acceleration/deceleration changeover speed 3 (sptc43) to the spindle sync multi-step acceleration/deceleration changeover speed 4 (sptc44) when the 4th step gear is selected. Set this as a magnification with respect to the spindle-mode servo control/spindle synchronization acceleration/deceleration time constant (spt4).</p> <p><b>---Setting range---</b></p> <p>0 to 127</p>		
<b>#13562</b>	<b>spdiv44</b>	<b>Time constant magnification for changeover speed 4 (Gear: 11)</b>
<p>Time constant magnification for changeover speed 4 (Gear: 11)</p> <p>Specify the acceleration/deceleration time constant to be used in a range of the spindle-mode servo control/spindle synchronization multi-step acceleration/deceleration changeover speed 4 (sptc44) to the spindle sync multi-step acceleration/deceleration changeover speed 5 (sptc45) when the 4th step gear is selected. Set this as a magnification with respect to the spindle-mode servo control/spindle synchronization acceleration/deceleration time constant (spt4).</p> <p><b>---Setting range---</b></p> <p>0 to 127</p>		
<b>#13563</b>	<b>spdiv45</b>	<b>Time constant magnification for changeover speed 5 (Gear: 11)</b>
<p>Time constant magnification for changeover speed 5 (Gear: 11)</p> <p>Specify the acceleration/deceleration time constant to be used in a range of the spindle-mode servo control/spindle synchronization multi-step acceleration/deceleration changeover speed 5 (sptc45) to the spindle sync multi-step acceleration/deceleration changeover speed 6 (sptc46) when the 4th step gear is selected. Set this as a magnification with respect to the spindle-mode servo control/spindle synchronization acceleration/deceleration time constant (spt4).</p> <p><b>---Setting range---</b></p> <p>0 to 127</p>		
<b>#13564</b>	<b>spdiv46</b>	<b>Time constant magnification for changeover speed 6 (Gear: 11)</b>
<p>Time constant magnification for changeover speed 6 (Gear: 11)</p> <p>Specify the acceleration/deceleration time constant to be used in a range of the spindle-mode servo control/spindle synchronization multi-step acceleration/deceleration changeover speed 6 (sptc46) to the spindle sync multi-step acceleration/deceleration changeover speed 7 (sptc47) when the 4th step gear is selected. Set this as a magnification with respect to the spindle-mode servo control/spindle synchronization acceleration/deceleration time constant (spt4).</p> <p><b>---Setting range---</b></p> <p>0 to 127</p>		

	<b>#13565</b>	<b>spdiv47</b>	<b>Time constant magnification for changeover speed 7 (Gear: 11)</b>
	Time constant magnification for changeover speed 7 (Gear: 11) Specify the acceleration/deceleration time constant to be used for the spindle-mode servo control/spindle synchronization multi-step acceleration/deceleration changeover speed 7 (sptc47) or a higher speed when the 4th step gear is selected. Set this as a magnification with respect to the spindle-mode servo control/spindle synchronization acceleration/deceleration time constant (spt4).		
	<b>---Setting range---</b>		
	0 to 127		
<b>(PR)</b>	<b>#43001</b>	<b>sgear_tret</b>	<b>Turret gear change ON</b>
	Not used. Set to "0".		
	<b>#43002</b>	<b>SGRA1</b>	<b>Spindle-side gear ratio 1</b>
	Not used. Set to "0".		
	<b>#43003</b>	<b>SGRA2</b>	<b>Spindle-side gear ratio 2</b>
	Not used. Set to "0".		
	<b>#43004</b>	<b>SGRA3</b>	<b>Spindle-side gear ratio 3</b>
	Not used. Set to "0".		
	<b>#43005</b>	<b>SGRA4</b>	<b>Spindle-side gear ratio 4</b>
	Not used. Set to "0".		
	<b>#43006</b>	<b>SGRB1</b>	<b>Motor shaft-side gear ratio 1</b>
	Not used. Set to "0".		
	<b>#43007</b>	<b>SGRB2</b>	<b>Motor shaft-side gear ratio 2</b>
	Not used. Set to "0".		
	<b>#43008</b>	<b>SGRB3</b>	<b>Motor shaft-side gear ratio 3</b>
	Not used. Set to "0".		
	<b>#43009</b>	<b>SGRB4</b>	<b>Motor shaft-side gear ratio 4</b>
	Not used. Set to "0".		
	<b>#43046</b>	<b>smax_tap1</b>	<b>Synchro tapping spindle Max rotation speed (Gear: 00)</b>
	Specify the maximum rotation speed in synchronous tapping multi-step acceleration/deceleration control when gear 00 is selected. Inclination of 3rd linear acceleration/deceleration control is determined by the ratio of smax_tap1(#43046) and tapt31(#3045). When "0" is set to smax_tap1, use smax1(#3005). When smax_tap1 is smax1 or more, use smax1.		
	<b>---Setting range---</b>		
	0 to 99999 (r/min)		
	<b>#43047</b>	<b>smax_tap2</b>	<b>Synchro tapping spindle Max rotation speed (Gear: 01)</b>
	Specify the maximum rotation speed in synchronous tapping multi-step acceleration/deceleration control when gear 01 is selected. Inclination of 3rd linear acceleration/deceleration control is determined by the ratio of smax_tap2(#43047) and tapt32(#3046). When "0" is set to smax_tap2, use smax2 (#3006). When smax_tap2 is smax2 or more, use smax2.		
	<b>---Setting range---</b>		
	0 to 99999 (r/min)		

<b>#43048</b>	<b>smax_tap3</b>	<b>Synchro tapping spindle Max rotation speed (Gear: 10)</b>
Specify the maximum rotation speed in synchronous tapping multi-step acceleration/deceleration control when gear 10 is selected. Inclination of 3rd linear acceleration/deceleration control is determined by the ratio of smax_tap3(#43048) and tapt33(#3047). When "0" is set to smax_tap3, use smax3 (#3007). When smax_tap3 is smax3 or more, use smax3.		
<b>---Setting range---</b>		
0 to 99999 (r/min)		
<b>#43049</b>	<b>smax_tap4</b>	<b>Synchro tapping spindle Max rotation speed (Gear: 11)</b>
Specify the maximum rotation speed in synchronous tapping multi-step acceleration/deceleration control when gear 11 is selected. Inclination of 3rd linear acceleration/deceleration control is determined by the ratio of smax_tap4(#43049) and tapt34(#3048). When 0 is set to smax_tap4, use smax4(#3008). When smax_tap4 is smax4 or more, use smax4.		
<b>---Setting range---</b>		
0 to 99999 (r/min)		
<b>#43070</b>	<b>loadrate_warn</b>	<b>Spindle motor equivalent load factor excess warning</b>
Not used.		
<b>#43071</b>	<b>sp_spd_flg_dtc_p</b>	<b>Delay time for starting spindle speed fluctuation detection</b>
Not used.		
<b>#43072</b>	<b>sp_spd_flg_dtc_r</b>	<b>Allowable spindle speed fluctuation rate</b>
Not used.		
<b>#43073</b>	<b>sp_spd_flg_dtc_i</b>	<b>Allowable spindle speed fluctuation range</b>
Not used.		
<b>#43074</b>	<b>zdet_num</b>	<b>Maximum number of revolutions for Z phase detection</b>
Not used.		

## 16.9 Spindle Parameters

<b>#13001</b>	<b>SP001 PGV</b>	<b>Position loop gain non-interpolation mode</b>
<p>Set the position loop gain for "Non-interpolation" control mode.            When the setting value increases, the command tracking ability will enhance and the positioning settling time can be shorter. However, the impact on the machine during acceleration/deceleration will increase.            Use the selection command, the control mode "bit 2, 1, 0 = 000" in control input 4.            (Note) The control mode is commanded by NC.</p> <p><b>---Setting range---</b>            1 to 200 (rad/s)</p>		
<b>#13002</b>	<b>SP002 PGN</b>	<b>Position loop gain interpolation mode</b>
<p>Set the position loop gain for "interpolation" control mode.            When the setting value increases, the command tracking ability will enhance and the positioning settling time can be shorter. However, the impact on the machine during acceleration/deceleration will increase.            Use the selection command, the control mode "bit 2, 1, 0 = 010 or 100" in control input 4.            (Note) The control mode is commanded by NC.            When carrying out the SHG control, set SP035/bitC to "1".</p> <p><b>---Setting range---</b>            1 to 200 (rad/s)</p>		
<b>#13003</b>	<b>SP003 PGS</b>	<b>Position loop gain spindle synchronization</b>
<p>Set the position loop gain for "spindle synchronization" control mode.            When the setting value increases, the command tracking ability will enhance and the positioning settling time can be shorter. However, the impact on the machine during acceleration/deceleration will increase.            Use the selection command, the control mode "bit 2, 1, 0 = 001" in control input 4.            (Note 1) The control mode is commanded by NC.            When carrying out the SHG control, set SP036/bit4 to "1".            (Note 2) Set the same value for the basic and synchronous spindles in spindle synchronization.</p> <p><b>---Setting range---</b>            1 to 200 (rad/s)</p>		
<b>#13004</b>	<b>SP004</b>	
<p>Not used. Set to "0".</p>		
<b>#13005</b>	<b>SP005 VGN1</b>	<b>Speed loop gain 1</b>
<p>Set the speed loop gain.            Set this according to the load inertia size.            The higher setting value will increase the accuracy of control, however, vibration tends to occur.            If vibration occurs, adjust by lowering by 20 to 30%.            The final value should be 70 to 80% of the value at which the vibration stops.</p> <p><b>---Setting range---</b>            1 to 9999</p>		
<b>#13006</b>	<b>SP006 VIA1</b>	<b>Speed loop lead compensation 1</b>
<p>Set the speed loop integral control gain.            The standard setting is "1900". Adjust the value by increasing/decreasing the value by about 100.            Raise this value to improve the contour tracking accuracy in high-speed cutting.            Lower this value when the position droop does not stabilize (when the vibration of 10 to 20Hz occurs).</p> <p><b>---Setting range---</b>            1 to 9999</p>		
<b>#13007</b>	<b>SP007 VIL1</b>	<b>Speed loop delay compensation 1</b>
<p>Set this parameter when the limit cycle occurs in the full-closed loop or overshooting occurs in positioning.            When setting this parameter, make sure to set the torque offset "SP050(TOF)".            When not using, set to "0".</p> <p><b>---Setting range---</b>            0 to 32767</p>		

<b>#13008</b>	<b>SP008 VGN2</b>	<b>Speed loop gain 2</b>
<p>Normally SP005(VGN1) is used.            By setting "SP035/bit1, SP035/bit9 or SP036/bit1=1", gain 2 can be used according to the application.            Gain 2 can also be used by setting "Speed gain set 2 changeover request (control input 5/ bitC) = 1".            Refer to SP005(VGN1) for adjustment procedures.</p> <p><b>---Setting range---</b>            1 to 9999</p>		
<b>#13009</b>	<b>SP009 VIA2</b>	<b>Speed loop lead compensation 2</b>
<p>Normally SP006(VIA1) is used.            By setting "SP035/bit1, SP035/bit9 or SP036/bit1=1", gain 2 can be used according to the application.            Gain 2 can also be used by setting "Speed gain set 2 changeover request (control input 5/ bitC) = 1".            Refer to SP006(VIA1) for adjustment procedures.</p> <p><b>---Setting range---</b>            1 to 9999</p>		
<b>#13010</b>	<b>SP010 VIL2</b>	<b>Speed loop delay compensation 2</b>
<p>Normally SP007(VIL1) is used.            By setting "SP035/bit1, SP035/bit9 or SP036/bit1=1", gain 2 can be used according to the application.            Gain 2 can also be used by setting "Speed gain set 2 changeover request (control input 5/ bitC) = 1".            Refer to SP007(VIL1) for adjustment procedures.</p> <p><b>---Setting range---</b>            0 to 32767</p>		
<b>#13011</b>	<b>SP011</b>	
Not used. Set to "0".		
<b>#13012</b>	<b>SP012</b>	
Not used. Set to "0".		
<b>#13013</b>	<b>SP013</b>	
Not used. Set to "0".		
<b>#13014</b>	<b>SP014 PY1</b>	<b>Minimum excitation rate 1</b>
<p>Set the minimum value for the variable excitation rate. The standard setting is "50".            Set to "0" when using an IPM spindle motor.            If noise including gear noise is loud, select a small value. However, a larger setting value is more effective for impact response.</p> <p>(Note) When setting a value at "50 or more", check if there is no problem with gear noise, motor excitation noise, vibration during low-speed rotation or vibration when the servo is locked during orientation stop, etc.            When setting a value at "less than 50", check if there is no problem with the impact load response or rigidity during servo lock.</p> <p><b>---Setting range---</b>            0 to 100 (%)</p>		
<b>#13015</b>	<b>SP015 PY2</b>	<b>Minimum excitation rate 2</b>
<p>Normally, SP014(PY1) is used.            By setting "SP035/bit2, SP035/bitA or SP036/bit2=1", the excitation rate 2 can be used according to the application.            The excitation rate 2 can also be used by setting "the minimum excitation rate 2 changeover request (control input 5/ bitB) = 1". Refer to SP014(PY1) for adjustment procedures.            Set to "0" when using an IPM spindle motor.</p> <p><b>---Setting range---</b>            0 to 100 (%)</p>		



#13016	SP016 DDT	Phase alignment deceleration rate
		<p>Set the single-rotation position alignment deceleration rate for orientation stopping, phase alignment while rotating and switching from non-interpolation mode to spindle synchronization mode while rotating. When the load inertia is larger, the setting value should be smaller. When the setting value is larger, the orientation in-position and single-rotation position alignment complete faster, but the impact applied on the machine will increase. To change the deceleration rate only during rotation command (command F Δ T ≠ 0), set this parameter together with SP070 (KDDT).</p> <p><b>---Setting range---</b></p> <p>1 to 32767 (0.1(r/min)/ms)</p>

(PR)	#13017	SP017 SPEC1	Spindle specification 1
		<p>Select the spindle specification. A function is allocated to each bit. Set this in hexadecimal format.</p> <p>Bit- F E D C B A 9 8 7 6 5 4 3 2 1 0</p>	

**bit F-C : msr Motor series selection**

- 0: 200V specification IM spindle motor
- 1: 200V specification IPM spindle motor
- 2: 400V specification IM spindle motor
- 3: 400V specification IPM spindle motor
- 4: 200V specification Tool spindle motor

**bit B-5 :**

Not used. Set to "0".

**bit 4 : fdir Position feedback**

Set the machine side encoder's installation polarity.  
 0: Forward polarity    1: Reverse polarity

**bit 3 : vfb Speed feedback filter**

0: Disable    1: Enable (4500Hz)

**bit 2 : seqh READY ON sequence**

0: Normal    1: High-speed

**bit 1 : dfbx Dual feedback control**

Control the position FB signal in full closed control by the combination of a motor side encoder and machine side encoder.  
 0: Stop    1: Start

Related parameters: SP051, SP052

**bit 0 : fdir2 Speed feedback polarity**

Set the motor side encoder's installation polarity by a built-in motor.  
 0: Forward polarity    1: Reverse polarity

(PR)	#13018	SP018 SPEC2	Spindle specification 2																
			<p>Select the spindle specification. A function is allocated to each bit. Set this in hexadecimal format.</p> <p>Bit- F E D C B A 9 8 7 6 5 4 3 2 1 0</p> <table border="1"> <tr> <td>0</td><td>0</td><td>0</td><td>0</td><td>0</td><td>0</td><td>0</td><td>0</td><td>0</td><td>0</td><td>0</td><td>0</td><td>0</td><td>0</td><td>0</td><td>0</td> </tr> </table> <p><b>bit F-A :</b> Not used. Set to "0".</p> <p><b>bit 9 : mpg Earth fault detection</b> 0: Disable 1: Enable (standard) Set "0" and it is constantly "Enable" for MDS-EJ-SP Series.</p> <p><b>bit 8 : spsu Command speed limit value</b> 0: 33,750 r/min 1: 135,000 r/min</p> <p><b>bit 7-6 :</b> Not used. Set to "0".</p> <p><b>bit 5 : mkch Coil switch function</b> 0: Disable 1: Enable</p> <p><b>bit 4-2 :</b> Not used. Set to "0".</p> <p><b>bit 1 : oplp Open loop control</b> This allows the operation in which no encoder feedback signals are used. It is used when adjusting the encoder, etc. 0: Disable 1: Enable</p> <p><b>bit 0 :</b> Not used. Set to "0".</p>	0	0	0	0	0	0	0	0	0	0	0	0	0	0	0	0
0	0	0	0	0	0	0	0	0	0	0	0	0	0	0	0				

(PR)	#13019	SP019 RNG1	Sub side encoder resolution
			<p>[For semi-closed loop] Set the same value as SP020 (RNG2). (Refer to the explanation of SP020.)</p> <p>[For full-closed loop] Set the number of pulses per revolution of the machine side encoder.</p> <p>When using the encoder interface unit MDS-EX-HR, use this with SP097(RNG1ex).</p> <p>Encoder OSE-1024 (ABZ pulse): SP019=4096, SP097=-1</p> <p>TS5690( 64 teeth): SP019 = 2000, SP097=0            TS5690( 90 teeth): SP019 = 2880, SP097=0            TS5690(128 teeth): SP019 = 4000, SP097=0            TS5690(192 teeth): SP019 = 6000, SP097=0            TS5690(256 teeth): SP019 = 8000, SP097=0            TS5690(384 teeth): SP019 =12000, SP097=0</p> <p>ERM280(1200 teeth): SP019 = 4800, SP097=0            ERM280(2048 teeth): SP019 = 8000, SP097=0</p> <p>MPCI : SP019 = 7200, SP097=0            MBE205: SP019 = 2000, SP097=0            GEL2449M(524,288(p/rev)): SP019=0, SP097=8</p> <p><b>---Setting range---</b>            When SP097=0, the setting range is from 0 to 32767 (kp)            When SP097≠0, the setting range is from 0 to 65535 (p)</p>

(PR)	#13020	SP020 RNG2	Main side encoder resolution
			Set the number of pulses per revolution of the motor side encoder. Set the standard parameters for the motor with frame.
			---Setting range---
			When SP098=0, the setting range is from 0 to 32767 (kp) When SP098≠0, the setting range is from 0 to 65535 (p)
(PR)	#13021	SP021 OLT	Overload detection time constant
			Set the detection time constant of Overload 1 (Alarm 50). (For Mitsubishi Electric adjustment) Normally, set to "60". Set to "300" when using an IPM spindle motor.
			---Setting range---
			1 to 15300 (s)
	#13022	SP022 OLL	Overload detection level
			Set the current detection level of "Overload 1" (Alarm 50) as a percentage against the motor short-time rated output current. (For Mitsubishi Electric adjustment) Normally, set to "120". Set to "100" when using an IPM spindle motor.
			---Setting range---
			1 to 200 (Short-time rated %)
	#13023	SP023 OD1	Excessive error detection width (interpolation mode - spindle synchronization)
			Set the excessive error detection width for the interpolation mode and spindle synchronization. The standard setting is "120". When set to "0", the excessive error detection will be ignored, so do not set to "0".
			---Setting range---
			1 to 32767 (°)
	#13024	SP024 INP	In-position width
			Set the in-position detection width. Set the positioning accuracy required to the machine. Lower setting value increases the positioning accuracy, but makes the cycle time (settling time) longer. The standard setting is "875".
			---Setting range---
			0 to 32767 (1°/1000)
	#13025	SP025 INP2	2nd in-position width
			Use this when detecting an in-position different from normal in-position width such as advancing the in-position signal. The adjustment procedure is the same as SP024 (INP). The standard setting is "875".
			---Setting range---
			0 to 32767 (1°/1000)
(PR)	#13026	SP026 TSP	Maximum motor speed
			Set the maximum motor speed. If the motor speed exceeds the set maximum speed, an overspeed alarm will occur.
			---Setting range---
			1 to 32767 (r/min)
	#13027	SP027 ZSP	Motor zero speed
			Set the motor speed for detecting zero speed. If the motor speed drops below the set speed, the zero speed signal turns ON. The standard setting is "50".
			---Setting range---
			1 to 1000 (r/min)

	<b>#13028</b>	<b>SP028 SDTS</b>	<b>Speed detection set value</b>
			Set the motor speed for detecting the speed. If the motor speed drops below the set speed, the speed detection signal turns ON. The standard setting is 10% of the maximum motor speed. <b>---Setting range---</b> 10 to 32767 (r/min)
	<b>#13029</b>	<b>SP029 SDTR</b>	<b>Speed detection reset width</b>
			Set the hysteresis width in which the speed detection changes from ON to OFF. If the setting value is small, the speed detection will chatter easily. The standard setting is "30". <b>---Setting range---</b> 10 to 1000 (r/min)
	<b>#13030</b>	<b>SP030 SDT2</b>	<b>2nd speed detection setting value</b>
			Set the specified speed of the specified speed output. When carrying out digital output of the specified speed output, set SP229/bitC to "1". It is not available for MDS-EJ-SP Series. <b>---Setting range---</b> 0 to 32767 (r/min)
<b>(PR)</b>	<b>#13031</b>	<b>SP031 MTYP</b>	<b>Motor type</b>
			Set the control system of the spindle drive unit. 2200: Semi closed loop control 4200: Full closed loop control by using spindle side ABZ pulse output encoder 6200: Full closed loop control by using spindle side serial output encoder

(PR)	#13032	SP032 PTYP	Power supply type/ Regenerative resistor type
------	--------	------------	---

**MDS-E/EH Series: Power supply type**

When connecting a power supply unit, set a code for each power supply unit.

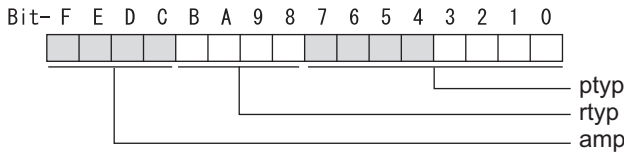

**bit F-C : amp**

Set the power backup function to be used.  
 No function used : 0  
 Deceleration and stop function at power failure : 8  
 Retraction function at power failure: C

**bit B-8 : rtp**

Not used. Set to "0".

**bit 7-0 : ptyp External emergency stop setting**

When the emergency stop input signal of the power supply unit is "disabled"

- Power supply unit is not connected : 00
- MDS-E-CV-37 / MDS-EH-CV-37 : 04
- MDS-E-CV-75 / MDS-EH-CV-75 : 08
- MDS-E-CV-110 / MDS-EH-CV-110 : 11
- MDS-E-CV-185 / MDS-EH-CV-185 : 19
- MDS-E-CV-300 / MDS-EH-CV-300 : 30
- MDS-E-CV-370 / MDS-EH-CV-370 : 37
- MDS-E-CV-450 / MDS-EH-CV-450 : 45
- MDS-E-CV-550 / MDS-EH-CV-550 : 55
- MDS-EH-CV-750 : 75

When the emergency stop input signal of the power supply unit is "enabled"

(Note) Set the power supply rotary switch to "4".

- Power supply unit is not connected : 00
- MDS-E-CV-37 / MDS-EH-CV-37 : 44
- MDS-E-CV-75 / MDS-EH-CV-75 : 48
- MDS-E-CV-110 / MDS-EH-CV-110 : 51
- MDS-E-CV-185 / MDS-EH-CV-185 : 59
- MDS-E-CV-300 / MDS-EH-CV-300 : 70
- MDS-E-CV-370 / MDS-EH-CV-370 : 77
- MDS-E-CV-450 / MDS-EH-CV-450 : 85
- MDS-E-CV-550 / MDS-EH-CV-550 : 95
- MDS-EH-CV-750 : B5

**MDS-EM/EMH Series: Power supply type**

Set as follows for the spindle drive section of the MDS-EM/EMH-SPV3.

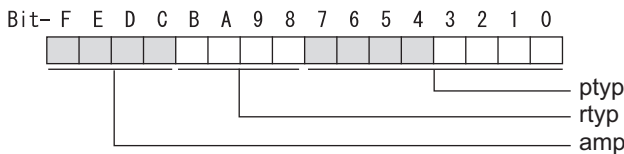

**bit F-C : amp**

Not used. Set to "0".

**bit B-8 : rtp**

Not used. Set to "0".

**bit 7-0 : ptyp External emergency stop setting**

- Normal
- MDS-EM: 20, MDS-EMH: 22, MDS-EM-SPV3-16040S: 16, MDS-EM-SPV3-320120: 37
- External emergency stop function
- MDS-EM: 60, MDS-EMH: 62, MDS-EM-SPV3-16040S: 56, MDS-EM-SPV3-320120: 77

**MDS-EJ-SP Series: Regenerative resistor type**

Set the regenerative resistor type.

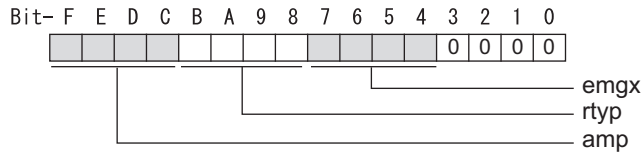

**bit F-8 : amp(bit F-C) / rtyp(bit B-8)**

- Setting prohibited : 10-12
- MR-RB12 or GZG200W39OHMK : 13
- MR-RB32 or GZG200W120OHMK 3 units connected in parallel : 14
- MR-RB30 or GZG200W39OHMK 3 units connected in parallel : 15
- MR-RB50 or GZG300W39OHMK 3 units connected in parallel : 16
- Setting prohibited : 17-1F
- Setting prohibited : 20-23
- FCUA-RB22 : 24
- FCUA-RB37 : 25
- FCUA-RB55 : 26
- FCUA-RB75/2 1 unit : 27
- R-UNIT1 : 28
- R-UNIT2 : 29
- R-UNIT3 : 2A
- R-UNIT4 : 2B
- R-UNIT5 : 2C
- FCUA-RB75/2 2 units connected in parallel : 2D
- FCUA-RB55/2 2 units connected in parallel : 2E
- Setting prohibited : 2F

**bit 7-4 : emgx External emergency stop function**

Set the external emergency stop function.  
0: Disable 4: Enable

**bit 3-0 :**

Not used. Set to "0".

<b>#13033</b>	<b>SP033 SFNC1</b>	<b>Spindle function 1</b>
---------------	--------------------	---------------------------

Select the spindle specification.  
 A function is allocated to each bit.  
 Set this in hexadecimal format.

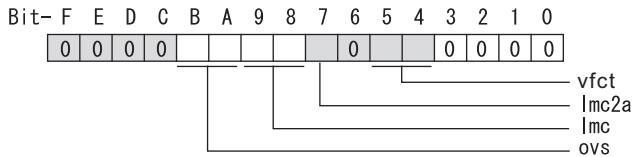

**bit F-C :**

Not used. Set to "0".

**bit B-A : ovs Overshoot compensation**

Set this parameter when overshooting occurs during positioning.  
 bitB,A=  
 00: Compensation stop  
 01: Setting prohibited  
 10: Setting prohibited  
 11: Compensation type 3

Set the compensation amount in SP043(OVS1) and SP042(OVS2).

**bit 9-8 : lmc Lost motion compensation type2**

Set this parameter when the protrusion at quadrant change is too large.  
 bit9,8=  
 00: Compensation stop  
 01: Setting prohibited  
 10: Compensation type 2  
 11: Setting prohibited  
 Set the compensation amount in SP048(LMC1) and SP041(LMC2).

**bit 7 : lmc2a Lost motion compensation 2 timing**

0: Normal    1: Change

**bit 6 :**

Not used. Set to "0".

**bit 5-4 : vfct Jitter compensation pulse number**

Suppress vibration by machine backlash when axis stops.  
 bit5,4=  
 00: Disable  
 01: 1 pulse  
 10: 2 pulse  
 11: 3 pulses

**bit 3-0 :**

Not used. Set to "0".

<b>#13034</b>	<b>SP034 SFNC2</b>	<b>Spindle function 2</b>
---------------	--------------------	---------------------------

Select the spindle function.  
 A function is allocated to each bit.  
 Set this in hexadecimal format.

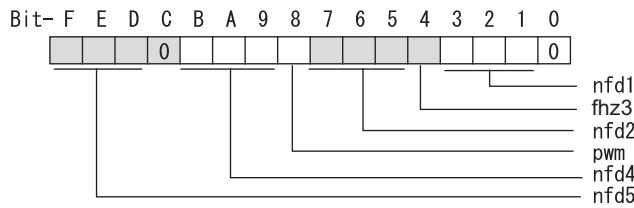

**bit F-D : nfd5 Depth of Notch filter 5**

Set the depth of Notch filter 5 (SP088).

- bit F,E,D=
- 000: -∞
- 001: -18.1[dB]
- 010: -12.0[dB]
- 011: -8.5[dB]
- 100: -6.0[dB]
- 101: -4.1[dB]
- 110: -2.5[dB]
- 111: -1.2[dB]

**bit C :**

Not used. Set to "0".

**bit B-9 : nfd4 Depth of Notch filter 4**

Set the depth of Notch filter 4 (SP087).

- bit B,A,9=
- 000: -∞
- 001: -18.1[dB]
- 010: -12.0[dB]
- 011: -8.5[dB]
- 100: -6.0[dB]
- 101: -4.1[dB]
- 110: -2.5[dB]
- 111: -1.2[dB]

**bit 8 : pwm Current control**

- 0: Standard current control    1: High frequency current control

**bit 7-5 : nfd2 Depth of Notch filter 2**

Set the depth of Notch filter 2 (SP046).

- bit 7,6,5=
- 000: -∞
- 001: -18.1[dB]
- 010: -12.0[dB]
- 011: -8.5[dB]
- 100: -6.0[dB]
- 101: -4.1[dB]
- 110: -2.5[dB]
- 111: -1.2[dB]

**bit 4 : fhz3 Notch filter 3**

- 0: Stop            1: Start (1125Hz)



**bit 3-1 : nfd1 Depth of Notch filter 1**

Set the depth of Notch filter 1 (SP038).  
 bit3,2,1=  
 000: -∞  
 001: -18.1[dB]  
 010: -12.0[dB]  
 011: -8.5[dB]  
 100: -6.0[dB]  
 101: -4.1[dB]  
 110: -2.5[dB]  
 111: -1.2[dB]

**bit 0 :**

Not used. Set to "0".

<b>(PR)</b>	<b>#13035</b>	<b>SP035 SFNC3</b>	<b>Spindle function 3</b>
-------------	---------------	--------------------	---------------------------

Select the spindle function.  
 A function is allocated to each bit.  
 Set this in hexadecimal format.

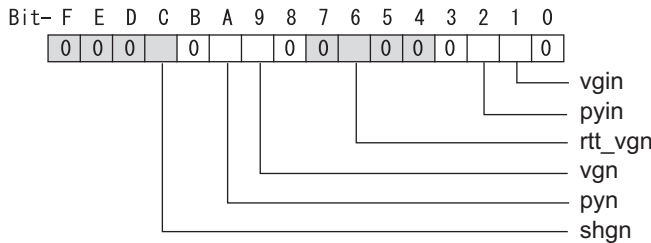

**bit F-D :**

Not used. Set to "0".

**bit C : shgn SHG control in interpolation mode**

0: Stop 1: Start  
 When using the OMR-FF control, set to "0".

**bit B :**

Not used. Set to "0".

**bit A : pyn Excitation rate selection in interpolation mode**

0: Select Excitation rate 1 1: Select Excitation rate 2

**bit 9 : vgn Speed loop gain set selection in interpolation mode**

0: Select Set 1 1: Select Set 2

**bit 8-7 :**

Not used. Set to "0".

**bit 6 : rtt\_vgn Real-time tuning I in non-interpolation mode / speed gain adaptation stop**

0: Stop 1: Start

**bit 5-3 :**

Not used. Set to "0".

**bit 2 : pyin Excitation rate selection in non-interpolation mode**

The excitation rate after the in-position can be selected.  
 0: Select Excitation rate 1 1: Select Excitation rate 2

**bit 1 : vgin Speed loop gain set selection in non-interpolation mode**

The speed loop gain set after the in-position can be selected.  
 0: Select Set 1 1: Select Set 2

**bit 0 :**

Not used. Set to "0".

<b>(PR)</b>	<b>#13036</b>	<b>SP036 SFNC4</b>	<b>Spindle function 4</b>
-------------	---------------	--------------------	---------------------------

Select the spindle function.  
A function is allocated to each bit.  
Set this in hexadecimal format.

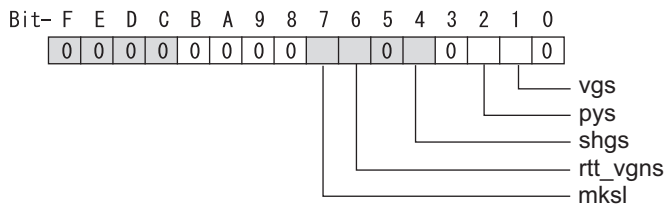

**bit F-8 :**

Not used. Set to "0".

**bit 7 : mksl Coil selection in spindle synchronization mode**

0: Select the coil commanded during synchronization 1: Select high-speed coil

**bit 6 : rtt\_vgns Real-time tuning I in spindle synchronization mode / speed gain adaptation stop**

0: Stop 1: Start

**bit 5 :**

Not used. Set to "0".

**bit 4 : shgs SHG control in spindle synchronization mode**

0: Stop 1: Start  
When using the OMR-FF control, set to "0".

**bit 3 :**

Not used. Set to "0".

**bit 2 : pys Excitation rate selection in spindle synchronization mode**

0: Select Excitation rate 1 1: Select Excitation rate 2

**bit 1 : vgs Speed loop gain set selection in spindle synchronization mode**

0: Select Set 1 (SP005,SP006,SP007) 1: Select Set 2 (SP008,SP009,SP010)

**bit 0 :**

Not used. Set to "0".

<b>#13037</b>	<b>SP037 JL</b>	<b>Load inertia scale</b>
---------------	-----------------	---------------------------

Set the motor axis conversion total load inertia including motor itself in proportion to the motor inertia.  
 $SV037(JL)=(Jm+JI)/Jm \times 100$   
 Jm: Motor inertia  
 JI: Motor axis conversion load inertia

**---Setting range---**

0 to 5000 (%)

<b>#13038</b>	<b>SP038 FHz1</b>	<b>Notch filter frequency 1</b>
---------------	-------------------	---------------------------------

Set the vibration frequency to suppress when machine vibration occurs.  
 (Enabled at 50 or more.)  
 When not using, set to "0".

Related parameters: SP034/bit3-1

**---Setting range---**

0 to 5000 (Hz)

<b>#13039</b>	<b>SP039 LMCD</b>	<b>Lost motion compensation timing</b>
---------------	-------------------	--

Set this parameter when the lost motion compensation type2 timing does not match.  
 Adjust by increasing the value by 10 at a time.

**---Setting range---**

0 to 2000 (ms)

<b>#13040</b>	<b>SP040 LMC2</b>	<b>Lost motion compensation non-sensitive band</b>
Set the non-sensitive band of the lost motion compensation in the feed forward control. When "0" is set, 2°/1000 is set. Adjust by increasing the value by 1°/1000 at a time.		
<b>---Setting range---</b>		
-32768 to 32767 (1°/1000)		
<b>#13041</b>	<b>SP041 LMC2</b>	<b>Lost motion compensation 2</b>
Set this parameter with SP048(LMC1) only to vary the lost motion compensation amount depending on the command directions. Normally, set to "0".		
<b>---Setting range---</b>		
-1 to 200 (Short-time rated %) Note that when SP227/bit2 is "1", the range will be -1 to 20000 (Short-time rated 0.01%).		
<b>#13042</b>	<b>SP042 OVS2</b>	<b>Overshooting compensation 2</b>
Set this parameter with SP043(OVS1) only to vary the lost motion compensation amount depending on the command directions. Normally, set to "0".		
<b>---Setting range---</b>		
-1 to 100 (Short-time rated %) Note that when SP227/bit2 is "1", the range will be -1 to 10000 (Short-time rated 0.01%).		
<b>#13043</b>	<b>SP043 OVS1</b>	<b>Overshooting compensation 1</b>
Set this parameter when overshooting occurs during positioning. This compensates the motor torque during positioning. This is valid only when the overshooting compensation SP033 (SFNC1/ovs) is selected.		
[Type 3 "When SP033/ bitB,A=11"] Use this when performing overshoot compensation in the feed forward control during arc cutting mode. Set the compensation amount based on the motor short-time rated current. Increase the value in increments of 1% to find the value where overshooting ceases.		
[To vary compensation amount depending on the direction] When SV042 (OVS2) is "0", change the SP043 (OVS1) value in both +/- directions to compensate. To change the compensation amount depending on the command direction, set this with SP042 (OVS2). (SP043: + direction, SP042: - direction, However, the directions may be opposite depending on other settings.) When "-1" is set, the compensation will not be performed in the command direction.		
<b>---Setting range---</b>		
-1 to 100 (Short-time rated %) Note that when SP227/bit2 is "1", the range will be -1 to 10000 (Short-time rated 0.01%).		
<b>#13044</b>	<b>SP044 OBS2</b>	<b>Disturbance observer gain</b>
Set the disturbance observer gain. The standard setting is "100". To use the disturbance observer, also set SP037(JL), SP045(OBS1) and SP226/ bitE. When not using, set to "0".		
<b>---Setting range---</b>		
0 to 500 (%)		
<b>#13045</b>	<b>SP045 OBS1</b>	<b>Disturbance observer filter frequency</b>
Set the disturbance observer filter band. Normally, set to "100". To use the disturbance observer, also set SP037(JL), SP044(OBS2) and SP226/ bitE. When not using, set to "0".		
<b>---Setting range---</b>		
0 to 1000 (rad/s)		

<b>#13046</b>	<b>SP046 FH2</b>	<b>Notch filter frequency 2</b>
<p>Set the vibration frequency to suppress when machine vibration occurs. (Enabled at 50 or more.) When not using, set to "0".</p> <p>Related parameters: SP034/bit7-5</p> <p><b>---Setting range---</b> 0 to 5000 (Hz)</p>		
<b>#13047</b>	<b>SP047 EC</b>	<b>Inductive voltage compensation gain</b>
<p>Set the inductive voltage compensation gain. Normally, set to "100". Lower the gain when the current FB peak exceeds the current command peak.</p> <p><b>---Setting range---</b> 0 to 200 (%)</p>		
<b>#13048</b>	<b>SP048 LMC1</b>	<b>Lost motion compensation 1</b>
<p>Set this parameter when the protrusion (that occurs due to the non-sensitive band by friction, torsion, backlash, etc.) at quadrant change is too large. This sets the compensation torque at quadrant change (when an axis feed direction is reversed) by Short-time rated %. Whether to enable the lost motion compensation and the method can be set with other parameters.</p> <p>[Type 2 "When SP033/bit9,8=10"] Set the compensation amount based on the motor short-time rated current. The standard setting is double of the friction torque. The compensation amount will be 0 when "0" is set.</p> <p>Related parameters: SP033/bit9-8, SP039, SP040, SP041, SP227/bit2</p> <p>[To vary compensation amount depending on the direction] When SP041 (LMC2) is "0", change SP048 (LMC1) value in both of +/- directions to compensate. To vary the compensation amount depending on the command direction, set this with SP041 (LMC2). (SP048: + direction, SP041: - direction, However, the directions may be opposite depending on other settings.) When "-1" is set, the compensation will not be performed in the command direction.</p> <p><b>---Setting range---</b> -1 to 200 (Short-time rated %) Note that when SP227/bit2 is "1", the range will be -1 to 20000 (Short-time rated 0.01%).</p>		
<b>#13049</b>	<b>SP049 FFC</b>	<b>Acceleration rate feed forward gain</b>
<p>When a relative error in the synchronous control is too large, set this parameter to the axis that is delaying. The standard setting is "0". The standard setting in the SHG control is "50". Adjust relative errors in acceleration/deceleration by increasing the value by 50.</p> <p><b>---Setting range---</b> 0 to 999 (%)</p>		
<b>#13050</b>	<b>SP050 TOF</b>	<b>Torque offset</b>
<p>Set the imbalance torque.</p> <p><b>---Setting range---</b> -100 to 100 (Short-time rated %)</p>		
<b>#13051</b>	<b>SP051 DFBT</b>	<b>Dual feed back control time constant</b>
<p>Set the control time constant in dual feed back. When the function is valid, the standard setting is "100". When "0" is set, the value is 1 ms. When the time constant is increased, the operation will get closer to the semi-closed control and the limit of the position loop gain will be raised. However, this cannot be used when the spindle slip occurs in machine configuration such as V-belt drive.</p> <p>Related parameters: SP017/bit1, SP052</p> <p><b>---Setting range---</b> 0 to 9999 (ms)</p>		

	<b>#13052</b>	<b>SP052 DFBN</b>	<b>Dual feedback control non-sensitive band</b>
			Set the non-sensitive band in the dual feedback control. Normally set to "0".
			Related parameters: SP017/bit1, SP051
			<b>---Setting range---</b> 0 to 9999 (1/1000°)
	<b>#13053</b>	<b>SP053 ODS</b>	<b>Excessive error detection width (non-interpolation mode)</b>
			Set the excessive error detection width in non-interpolation mode. Standard setting value: ODS = Maximum motor speed [r/min] × 6/PGV/2
			When set to "0", the excessive error detection will not be performed.
			<b>---Setting range---</b> 0 to 32767 (°)
	<b>#13054</b>	<b>SP054 ORE</b>	<b>Overrun detection width in closed loop control</b>
			Set the overrun detection width in the full-closed loop control. When the gap between the motor side encoder and the machine side encoder exceeds the set value, it is judged as an overrun and "Alarm 43" is detected. When "-1" is set, if the differential velocity between the motor side encoder and the machine side encoder exceeds the 30% of the maximum motor speed, it will be judged as overrun and "Alarm 43" will be detected. When "0" is set, overrun will be detected with 2°. In the full-closed loop control, normally set this parameter to "360". During V-belt drive, set to "-1".
			<b>---Setting range---</b> -1 to 32767 (°)
	<b>#13055</b>	<b>SP055 EMGx</b>	<b>Max. gate off delay time after emergency stop</b>
			Set the time required to forcibly execute READY OFF after the emergency stop is input. Normally set to "5000". When 5000ms or more is set for deceleration time constant at emergency stop(SP056), set the same value as SP056. When using the power backup system (MDS-D/DH-PFU) and setting the value of this parameter to 5000ms or more, a communication error between NC and drive unit may occur when power restarts after a instantaneous power interrupt. It is not a problem so turn the NC power ON again to start up. When "0" is set, 7000ms is the actual value to be set.
			Related parameters: SP056, SP230
			<b>---Setting range---</b> 0 to 29900 (ms)
	<b>#13056</b>	<b>SP056 EMGt</b>	<b>Deceleration time constant at emergency stop</b>
			Set the time constant used for the deceleration control at emergency stop. Set the time required to stop from the maximum motor speed (TSP). When "0" is set, the deceleration control is executed with "7000ms".
			Related parameters: SP055, SP230
			<b>---Setting range---</b> 0 to 29900 (ms)
<b>(PR)</b>	<b>#13057</b>	<b>SP057 GRA1</b>	<b>Spindle side gear ratio 1</b>
			Set the number of gear teeth on the spindle side when "the gear selection command (control input 4/bit6, 5)" is set to "00".
			<b>---Setting range---</b> 1 to 32767
<b>(PR)</b>	<b>#13058</b>	<b>SP058 GRA2</b>	<b>Spindle side gear ratio 2</b>
			Set the number of gear teeth on the spindle side when "the gear selection command (control input 4/bit6, 5)" is set to "01".
			<b>---Setting range---</b> 1 to 32767

<b>(PR)</b>	<b>#13059</b>	<b>SP059 GRA3</b>	<b>Spindle side gear ratio 3</b>
			Set the number of gear teeth on the spindle side when "the gear selection command (control input 4/bit6, 5)" is set to "10".
			<b>---Setting range---</b>
			1 to 32767
<b>(PR)</b>	<b>#13060</b>	<b>SP060 GRA4</b>	<b>Spindle side gear ratio 4</b>
			Set the number of gear teeth on the spindle side when "the gear selection command (control input 4/bit6, 5)" is set to "11".
			<b>---Setting range---</b>
			1 to 32767
<b>(PR)</b>	<b>#13061</b>	<b>SP061 GRB1</b>	<b>Motor side gear ratio 1</b>
			Set the number of gear teeth on the motor side when "the gear selection command (control input 4/bit6, 5)" is set to "00".
			<b>---Setting range---</b>
			1 to 32767
<b>(PR)</b>	<b>#13062</b>	<b>SP062 GRB2</b>	<b>Motor side gear ratio 2</b>
			Set the number of gear teeth on the motor side when "the gear selection command (control input 4/bit6, 5)" is set to "01".
			<b>---Setting range---</b>
			1 to 32767
<b>(PR)</b>	<b>#13063</b>	<b>SP063 GRB3</b>	<b>Motor side gear ratio 3</b>
			Set the number of gear teeth on the motor side when "the gear selection command (control input 4/bit6, 5)" is set to "10".
			<b>---Setting range---</b>
			1 to 32767
<b>(PR)</b>	<b>#13064</b>	<b>SP064 GRB4</b>	<b>Motor side gear ratio 4</b>
			Set the number of gear teeth on the motor side when "the gear selection command (control input 4/bit6, 5)" is set to "11".
			<b>---Setting range---</b>
			1 to 32767
	<b>#13065</b>	<b>SP065 TLM1</b>	<b>Torque limit 1</b>
			Set the torque limit value when the torque limit (spindle control input 1/bitA, 9, 8) is set to "001" (TL3, TL2, TL1 = 001).
			<b>---Setting range---</b>
			0 to 999 (Short-time rated %)
	<b>#13066</b>	<b>SP066 TLM2</b>	<b>Torque limit 2</b>
			Set the torque limit value when the torque limit (spindle control input 1/bitA, 9, 8) is set to "010" (TL3, TL2, TL1 = 010).
			<b>---Setting range---</b>
			0 to 999 (Short-time rated %)
	<b>#13067</b>	<b>SP067 TLM3</b>	<b>Torque limit 3</b>
			Set the torque limit value when the torque limit (spindle control input 1/bitA, 9, 8) is set to "011" (TL3, TL2, TL1 = 011).
			<b>---Setting range---</b>
			0 to 999 (Short-time rated %)
	<b>#13068</b>	<b>SP068 TLM4</b>	<b>Torque limit 4</b>
			Set the torque limit value when the torque limit (spindle control input 1/bitA, 9, 8) is set to "100" (TL3, TL2, TL1 = 100).
			<b>---Setting range---</b>
			0 to 999 (Short-time rated %)

<b>#13069</b>	<b>SP069 PCMP</b>	<b>Phase alignment completion width</b>
<p>Set the single-rotation position alignment completion width for phase alignment and changing from non-interpolation to spindle synchronization mode during rotation.                  Set the rotation error that is required to the machine.                  When the setting value decreases, the rotation error will decrease, but the cycle time (settling time) will get longer. The standard setting is "875".</p> <p><b>---Setting range---</b>                  0 to 32767 (1°/1000)</p>		

<b>#13070</b>	<b>SP070 KDDT</b>	<b>Phase alignment deceleration rate scale</b>
<p>Set the scale for SP016 (DDT) to change the deceleration rate only during rotation command (command F Δ T ≠ 0).                  When the setting value increases, the single-rotation position alignment will be completed faster, but the impact to the machine will also increase. When not using, set to "0".</p> <p><b>---Setting range---</b>                  0 to 255 (1/16-fold)</p>		

<b>#13071</b>	<b>SP071 DIQM</b>	<b>Variable current limit during deceleration, lower limit value</b>
<p>Set this parameter to adjust the deceleration time by changing the current limit value during deceleration depending on the motor speed.                  As shown below, set the lower limit rate of the current limit in SP071 (DIQM), and use with SP072 (DIQN).                  When DIQM is set to 100%, the standard current limit value in deceleration (SP152) is applied.</p>		

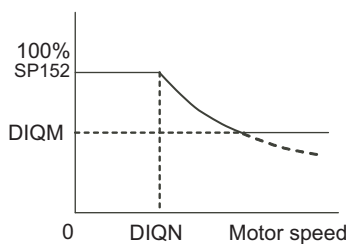

**---Setting range---**  
 0 to 999 (%)

<b>#13072</b>	<b>SP072 DIQN</b>	<b>Variable current limit during deceleration, break point speed</b>
---------------	-------------------	--

Set this parameter to adjust the deceleration time by changing the current limit value during deceleration depending on the motor speed.  
 As shown below, set the lower limit rate of the current limit in SP071 (DIQM), and use with SP072 (DIQN).  
 When DIQN is set to 100%, the standard current limit value in deceleration (SP152) is applied.

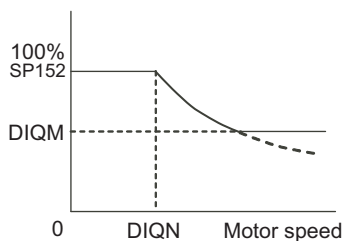

**---Setting range---**  
 1 to 32767 (r/min)

**#13073 SP073 VGVN Variable speed gain target value**

If noise is bothersome during high speed rotation, it may be reduced by lowering the speed loop gain at high speed.  
 Set this value to ensure the adequate response by suppressing noise and vibration at low speeds and increasing the speed loop gain at high speeds for a high-speed spindle of machining center, etc.  
 As shown below, set the speed loop gain rate for the overspeed detection speed in SP073 (VGVN), and use with SP074 (VGVS).  
 When not using, set to "0".  
 The overspeed detection speed (VLMT) is 115% of the maximum motor speed (TSP).  
 This function can be used when either Speed loop gain set 1 or Speed loop gain set 2 is selected.

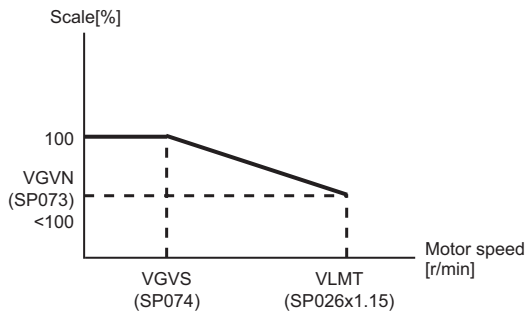

When lowering the speed loop gain at high speed

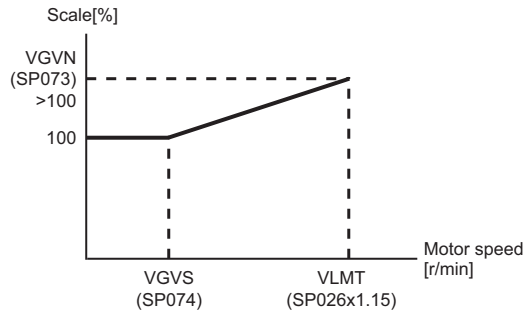

When increasing the speed loop gain at high speed

**---Setting range---**

0 to 999 (%)

**#13074 SP074 VGVS Variable speed gain change start speed**

If noise is bothersome during high speed rotation, it may be reduced by lowering the speed loop gain at high speed.  
 Set this value to ensure the adequate response by suppressing noise and vibration at low speeds and increasing the speed loop gain at high speeds for a high-speed spindle of machining center, etc.  
 As shown below, set the speed loop gain rate for the overspeed detection speed in SP073 (VGVN), and use with SP074 (VGVS).  
 When not using, set to "0".  
 The overspeed detection speed (VLMT) is 115% of the maximum motor speed (TSP).  
 This function can be used when either Speed loop gain set 1 or Speed loop gain set 2 is selected.

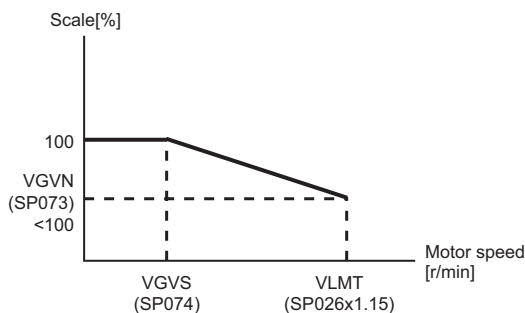

When lowering the speed loop gain at high speed

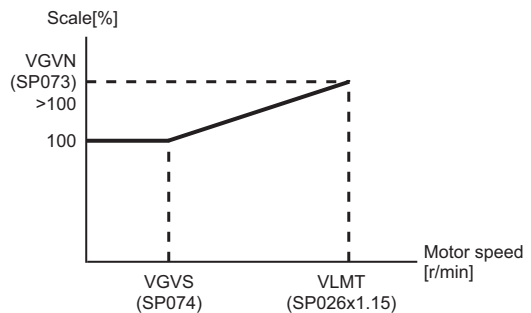

When increasing the speed loop gain at high speed

**---Setting range---**

0 to 32767 (r/min)

**#13075 SP075 DWSH Slip compensation scale during regeneration high-speed coil**

Set the slip frequency scale during deceleration.  
 Normally, set to "0". (For Mitsubishi Electric adjustment)

**---Setting range---**

0 to 255 (1/16-fold)



<b>#13076</b>	<b>SP076 DWSL</b>	<b>Slip compensation scale during regeneration low-speed coil</b>
<p>Set the slip frequency scale at deceleration when using the low-speed coil. Normally, set to "0". (For Mitsubishi Electric adjustment)</p> <p>---Setting range---</p> <p>0 to 255 (1/16-fold)</p>		
<b>#13077</b>	<b>SP077 IQA</b>	<b>Q axis current lead compensation</b>
<p>Set the current loop gain. To use the coil switch function, set the current loop gain for when the high-speed coil is selected. The setting value is determined by the motor's electrical characteristics so that the value is fixed to each motor used. Set the value given in the spindle parameter list. (For Mitsubishi Electric adjustment)</p> <p>---Setting range---</p> <p>1 to 20480</p>		
<b>#13078</b>	<b>SP078 IDA</b>	<b>D axis current lead compensation</b>
<p>Set the current loop gain. To use the coil switch function, set the current loop gain for when the high-speed coil is selected. The setting value is determined by the motor's electrical characteristics so that the value is fixed to each motor used. Set the value given in the spindle parameter list. (For Mitsubishi Electric adjustment)</p> <p>---Setting range---</p> <p>1 to 20480</p>		
<b>#13079</b>	<b>SP079 IQG</b>	<b>Q axis current gain</b>
<p>Set the current loop gain. To use the coil switch function, set the current loop gain for when the high-speed coil is selected. The setting value is determined by the motor's electrical characteristics so that the value is fixed to each motor used. Set the value given in the spindle parameter list. (For Mitsubishi Electric adjustment)</p> <p>---Setting range---</p> <p>1 to 8192</p>		
<b>#13080</b>	<b>SP080 IDG</b>	<b>D axis current gain</b>
<p>Set the current loop gain. To use the coil switch function, set the current loop gain for when the high-speed coil is selected. The setting value is determined by the motor's electrical characteristics so that the value is fixed to each motor used. Set the value given in the spindle parameter list. (For Mitsubishi Electric adjustment)</p> <p>---Setting range---</p> <p>1 to 8192</p>		
<b>#13081</b>	<b>SP081 IQAL</b>	<b>Q axis current lead compensation low-speed coil</b>
<p>When using coil switch function, set the current loop gain for when the low-speed coil is selected. The setting value is determined by the motor's electrical characteristics so that the value is fixed to each motor used. Set the value given in the spindle parameter list. (For Mitsubishi Electric adjustment)</p> <p>---Setting range---</p> <p>1 to 20480</p>		
<b>#13082</b>	<b>SP082 IDAL</b>	<b>D axis current lead compensation low-speed coil</b>
<p>When using coil switch function, set the current loop gain for when the low-speed coil is selected. The setting value is determined by the motor's electrical characteristics so that the value is fixed to each motor used. Set the value given in the spindle parameter list. (For Mitsubishi Electric adjustment)</p> <p>---Setting range---</p> <p>1 to 20480</p>		

<b>#13083</b>	<b>SP083 IQGL</b>	<b>Q axis current gain low-speed coil</b>
<p>When using coil switch function, set the current loop gain for when the low-speed coil is selected. The setting value is determined by the motor's electrical characteristics so that the value is fixed to each motor used. Set the value given in the spindle parameter list. (For Mitsubishi Electric adjustment)</p> <p><b>---Setting range---</b> 1 to 8192</p>		
<b>#13084</b>	<b>SP084 IDGL</b>	<b>D axis current gain low-speed coil</b>
<p>When using coil switch function, set the current loop gain for when the low-speed coil is selected. The setting value is determined by the motor's electrical characteristics so that the value is fixed to each motor used. Set the value given in the spindle parameter list. (For Mitsubishi Electric adjustment)</p> <p><b>---Setting range---</b> 1 to 8192</p>		
<b>#13085</b>	<b>SP085</b>	
Not used. Set to "0".		
<b>#13086</b>	<b>SP086</b>	
Not used. Set to "0".		
<b>#13087</b>	<b>SP087 FHZ4</b>	<b>Notch filter frequency 4</b>
<p>Set the vibration frequency to suppress when machine vibration occurs. (Enabled at 50 or more.) When not using, set to "0".</p> <p>Related parameters: SP034/bitB-9</p> <p><b>---Setting range---</b> 0 to 5000 (Hz)</p>		
<b>#13088</b>	<b>SP088 FHZ5</b>	<b>Notch filter frequency 5</b>
<p>Set the vibration frequency to suppress when machine vibration occurs. (Enabled at 50 or more.) When not using, set to "0".</p> <p>Related parameters: SP034/bitF-D</p> <p><b>---Setting range---</b> 0 to 5000 (Hz)</p>		
<b>#13089</b>	<b>SP089 TMKQ</b>	<b>Spindle output stabilizing gain Q axis</b>
<p>Set the magnification of the torque current stabilizing gain. (For Mitsubishi Electric adjustment) When set to "0", the torque current stabilization is disabled. When not using, set to "0".</p> <p><b>---Setting range---</b> 0 to 32767</p>		
<b>#13090</b>	<b>SP090 TMKD</b>	<b>Spindle output stabilizing gain D axis</b>
<p>Set the magnification of the excitation current stabilizing gain. (For Mitsubishi Electric adjustment) When set to "0", the excitation current stabilization is disabled. When not using, set to "0".</p> <p><b>---Setting range---</b> 0 to 32767</p>		
<b>#13091</b>	<b>SP091</b>	
Not used. Set to "0".		
<b>#13092</b>	<b>SP092</b>	
Not used. Set to "0".		
<b>#13093</b>	<b>SP093</b>	
Not used. Set to "0".		

<b>#13094</b>	<b>SP094 MPV</b>	<b>Magnetic pole error detection speed</b>
<p>In the magnetic pole position detection function, the command motor speed and motor speed during the position command stop are monitored.</p> <p>Set the command motor speed level and motor speed level during the position command stop in "r/min" unit. When the command motor speed level is set to "0", the magnetic pole position error is detected at 10r/min. Set to "10" as a standard setting when the magnetic pole position error detection function is enabled. This detects the magnetic pole position error when the motor speed is "100r/min".</p> <p>Ten-thousands digit, Thousands digit ----- Command motor speed level (10r/min)          Hundreds digit, Tens digit, Ones digit ----- Motor speed level (10r/min)</p> <p><b>---Setting range---</b>          0 to 31999</p>		
<b>#13095</b>	<b>SP095 VIAX</b>	<b>Lead compensation scale during high-response acceleration/deceleration</b>
<p>Set the magnification against delay/lead compensation (SP006) of the high-response acceleration/deceleration (valid when SP226/ bitD is set to "1"). Normally, set to "0". Set this parameter to suppress overshooting when the speed is reached.</p> <p><b>---Setting range---</b>          0 to 10000 (0.01%)</p>		
<b>#13096</b>	<b>SP096 SDW</b>	<b>Speed slowdown allowable width</b>
<p>When the spindle slows down due to multiple cutting, set the processable speed as percentage against the NC command speed.</p> <p>If the speed reduces below the tolerable range, the alarm 23 (Excessive speed error) will occur.</p> <p>(E.g.) When set to 90 [%]          If S1000 is commanded, the speed reduced by 900r/min (=1000r/min × 90%) is the allowable lower limit. Thus if the spindle speed reduces to 100r/min or below, the alarm will occur.</p> <p>When "0" is set, the magnification is the same as when "85" is set. When set to "-1", the allowable width will be disabled.</p> <p><b>---Setting range---</b>          -1,0 to 100 (%)</p>		
<b>#13097</b>	<b>SP097 RNG1ex</b>	<b>Extension sub side encoder resolution</b>
<p>When setting the machine side encoder resolution in pulse (p) unit, set the number of pulses to four bite data of SP097 (high-order) and SP019 (low-order) in pulse (p) unit.</p> <p>When SP097=0, the setting unit of SP019 is (kp). Refer to SP019 for details.</p> <p>Related parameters: SP019, SP020, SP098</p> <p><b>---Setting range---</b>          -1 to 32767</p>		
<b>#13098</b>	<b>SP098 RNG2ex</b>	<b>Extension main side encoder resolution</b>
<p>When setting the motor side encoder resolution in pulse (p) unit, set the number of pulses to four bite data of SP098 (high-order) and SP020 (low-order) in pulse (p) unit.</p> <p>When SP098=0, the setting unit of SP020 is (kp). Refer to SP020 for details.</p> <p>Related parameters: SP019, SP020, SP097</p> <p><b>---Setting range---</b>          -1 to 32767</p>		
<b>#13099-13105</b>	<b>SP099-SP105</b>	
<p>Not used. Set to "0".</p>		

<b>#13106</b>	<b>SP106 PGM</b>	<b>OMR-FF scale model gain</b>
<p>Set the scale model gain (position response) in OMR-FF control.  Set the same value as SV002(PGN).  Increase the setting value to perform a high-speed machining such as a fine arc or to improve the path error.  Lower the value when vibration occurs during acceleration/deceleration.  Set to "0" when not using OMR-FF control.</p> <p><b>---Setting range---</b>  0 to 300 (rad/s)</p>		
<b>#13107- 13111</b>	<b>SP107-SP111</b>	
<p>Not used. Set to "0".</p>		
<b>#13112</b>	<b>SP112 IFF</b>	<b>OMR-FF current feed forward gain</b>
<p>Set the current feed forward rate in OMR-FF control.  The standard setting is "10000".  Setting value of 0 is equal to "10000(100%)" setting.  Set to "0" when not using OMR-FF control.</p> <p><b>---Setting range---</b>  0 to 32767 (0.01%)</p>		
<b>#13113</b>	<b>SP113 OPLP</b>	<b>Current command value for open loop</b>
<p>Set the current command value for when the open loop control is enabled.  When "0" is set, the state will be the same as when "50" is set.  When not using, set to "0".  The open loop control is enabled when "SP018/bit1" is set to "1".</p> <p><b>---Setting range---</b>  0 to 999 (Short-time rated %)</p>		
<b>#13114</b>	<b>SP114 MKT</b>	<b>Coil changeover gate cutoff timer</b>
<p>Set the time required to cut off the gate when turning OFF/ON the coil switch contactor.  The value should be longer than the coil switch contactor's OFF/ON time.  The standard setting is "150".</p> <p><b>---Setting range---</b>  0 to 3500 (ms)</p>		
<b>#13115</b>	<b>SP115 MKT2</b>	<b>Coil changeover current limit timer</b>
<p>Set the time required to limit the current immediately after the coil switch contactor ON/OFF is completed and the gate is turned ON.  The standard setting is "250".</p> <p><b>---Setting range---</b>  0 to 3500 (ms)</p>		
<b>#13116</b>	<b>SP116 MKIL</b>	<b>Coil changeover current limit value</b>
<p>Set the time required to limit the current immediately after the coil switch contactor ON/OFF is completed and the gate is turned ON.  The standard setting is "120".</p> <p><b>---Setting range---</b>  0 to 999 (Short-time rated %)</p>		
<b>#13117</b>	<b>SP117 SETM</b>	<b>Excessive speed deviation timer</b>
<p>Set the time to detect the speed excessive error alarm.  Set the time required to the machine.  The standard setting is "12".</p> <p><b>---Setting range---</b>  0 to 60 (s)</p>		

<b>(PR)</b>	<b>#13118</b>	<b>SP118 MSFT</b>	<b>Magnetic pole shift amount</b>
			Set the magnetic pole shift amount of IPM spindle motor. During DC excitation of the initial setup: Set the same value displayed in the "AFLT gain" on the NC monitor screen in SP225/bit4=1. When not using, set to "0".  <b>---Setting range---</b> -18000 to 18000 (electrical angle 0.01°)
	<b>#13119</b>	<b>SP119</b>	
			Not used. Set to "0".
	<b>#13120</b>	<b>SP120</b>	
			Not used. Set to "0".
	<b>#13121</b>	<b>SP121 MP Kpp</b>	<b>Magnetic pole detection position loop gain</b>
			Set the position loop gain in the magnetic polar detection loop. This is used in the initial magnetic polar detection when the IPM spindle motor is turned ON. Set to "0" when using an IM spindle motor.  <b>---Setting range---</b> 0 to 32767
	<b>#13122</b>	<b>SP122 MP Kvp</b>	<b>Magnetic pole detection speed loop gain</b>
			Set the speed loop gain in the magnetic polar detection loop. This is used in the initial magnetic polar detection when the IPM spindle motor is turned ON. Set to "0" when using an IM spindle motor.  <b>---Setting range---</b> 0 to 32767
	<b>#13123</b>	<b>SP123 MP Kvi</b>	<b>Magnetic pole detection speed loop lead compensation</b>
			Set the speed loop lead compensation in the magnetic polar detection loop. This is used in the initial magnetic polar detection when the IPM spindle motor is turned ON. Set to "0" when using an IM spindle motor.  <b>---Setting range---</b> 0 to 32767
	<b>#13124</b>	<b>SP124 ILMTsp</b>	<b>Magnetic pole detection current limit value</b>
			Set the current limit value for the magnetic polar detection loop. This is used in the initial magnetic polar detection when the IPM spindle motor is turned ON. Set to "0" when using an IM spindle motor.  <b>---Setting range---</b> 0 to 999 (Short-time rated %)
	<b>#13125</b>	<b>SP125 DA1NO</b>	<b>D/A output ch1 data No. / Initial DC excitation level</b>
			Input the desired data number to D/A output channel. When using the 2-axis drive unit, set "-1" to the axis that the data will not be output.  When the DC excitation is running: Use in the DC excitation function. DC excitation: Set the initial excitation level when SP225/bit4=1. When "0" is set, the state will be the same as when "20" is set.  <b>---Setting range---</b> -32768 to 32767
	<b>#13126</b>	<b>SP126 DA2NO</b>	<b>D/A output ch2 data No. / Final DC excitation level</b>
			Input the desired data number to D/A output channel. When using the 2-axis drive unit, set "-1" to the axis that the data will not be output.  When the DC excitation is running: Use in the DC excitation function. DC excitation: Set the final excitation level when SP225/bit4=1. When "0" is set, the state will be the same as when "50" is set.  <b>---Setting range---</b> -32768 to 32767

	<b>#13127</b>	<b>SP127 DA1MPY</b>	<b>D/A output ch1 output scale / Initial DC excitation time</b>
	<p>Set the output scale in increments of 1/100. When "0" is set, the scale is the same as when "100" is set.</p> <p>When the DC excitation is running: Use in the DC excitation function. DC excitation: Set the initial excitation time when SP225/bit4=1. When "0" is set, the state will be the same as when "10000" is set.</p> <p><b>---Setting range---</b> -32768 to 32767 (1/100-fold)</p>		
	<b>#13128</b>	<b>SP128 DA2MPY</b>	<b>D/A output ch2 output scale</b>
	<p>Set the output scale in increments of 1/100. When "0" is set, the scale is the same as when "100" is set.</p> <p><b>---Setting range---</b> -32768 to 32767 (1/100-fold)</p>		
<b>(PR)</b>	<b>#13129- 13141</b>	<b>SP129-SP141</b>	
	<p>Set the unique constants for the spindle motor. (High-speed coil) The setting value is determined by the motor's mechanical and electrical characteristics and specifications, so normally set the value given in the spindle parameter list.</p>		
<b>(PR)</b>	<b>#13142</b>	<b>SP142</b>	
	<p>Set the unique constants for the spindle motor. (High-speed coil) The setting value is determined by the motor's mechanical and electrical characteristics and specifications, so normally set the value given in the spindle parameter list. For IPM spindle motor This parameter is used in initial magnetic pole detection of IPM spindle motor. (1) Pulse application time: Set it in [<math>\mu</math>s] unit. (0 &lt; application time &lt; 350) (2) Pulse application coil: To select a low-speed coil, add 1000 to the pulse application time. (3) Polarity of estimated magnetic pole: When it is set to the reverse polarity, add "-" to the total of (1) and (2). E.g.: When performing 333<math>\mu</math>s pulse-applied magnetic pole estimation in a low-speed coil and selecting the reverse polarity for the estimated polarity SP142 = -(333+1000) = -1333</p>		
<b>(PR)</b>	<b>#13143- 13160</b>	<b>SP143-SP160</b>	
	<p>Set the unique constants for the spindle motor. (High-speed coil) The setting value is determined by the motor's mechanical and electrical characteristics and specifications, so normally set the value given in the spindle parameter list.</p>		
<b>(PR)</b>	<b>#13161- 13192</b>	<b>SP161-SP192</b>	
	<p>Set the unique constants for the spindle motor. (Low-speed coil) The setting value is determined by the motor's mechanical and electrical characteristics and specifications, so normally set the value given in the spindle parameter list.</p>		
	<b>#13193</b>	<b>SP193 LMR</b>	<b>Change magnification for load meter standard output (High-speed coil)</b>
	<p>Set the standard output to be displayed as 100% in load meter using the short-time rated output ratio. To display the continuous rated output as 100%, set as follows. Continuous rated output/Short-time rated output <math>\times</math> 100 When "0" is set, the standard output to be displayed as 100% in load meter will be the short-time rated output. (Note) When several output characteristics such as 15-minute rating and 30-minute rating are plotted on the characteristics figure, set the change magnification for the characteristic with the highest rated output.</p> <p><b>---Setting range---</b> 0 to 100 (%)</p>		

<b>#13194</b>	<b>SP194 LMN</b>	<b>Base speed for load meter standard output (High-speed coil)</b>
---------------	------------------	--

Set the base speed of the standard output to be displayed as 100% in load meter.  
 To display the continuous rated output as 100%, set the base speed of the continuous rated output as follows.

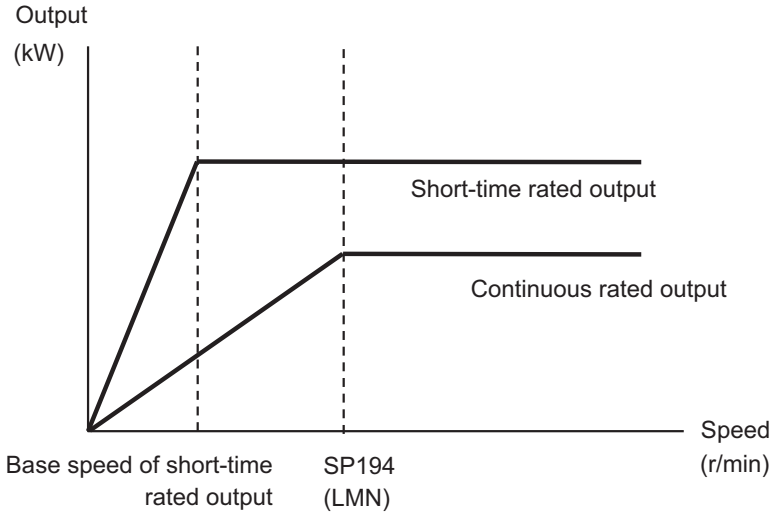

When "0" is set, the base speed of the short-time rated output will be applied.

(Note) When the speed is less than the base speed, the standard output to be displayed as 100% in load meter changes with the motor speed.

**---Setting range---**

0 to 32767 (r/min)

<b>#13195</b>	<b>SP195 LMRL</b>	<b>Change magnification for load meter standard output (Low-speed coil)</b>
---------------	-------------------	---

Set the standard output to be displayed as 100% in load meter using the short-time rated output ratio.  
 To display the continuous rated output as 100%, set as follows.

Continuous rated output/Short-time rated output × 100

When "0" is set, the standard output to be displayed as 100% in load meter will be the short-time rated output.

(Note) When several output characteristics such as 15-minute rating and 30-minute rating are plotted on the characteristics figure, set the change magnification for the characteristic with the highest rated output.

**---Setting range---**

0 to 100 (%)

<b>#13196</b>	<b>SP196 LMNL</b>	<b>Base speed for load meter standard output (Low-speed coil)</b>
---------------	-------------------	---

Set the base speed of the standard output to be displayed as 100% in load meter.  
 To display the continuous rated output as 100%, set the base speed of the continuous rated output as follows.

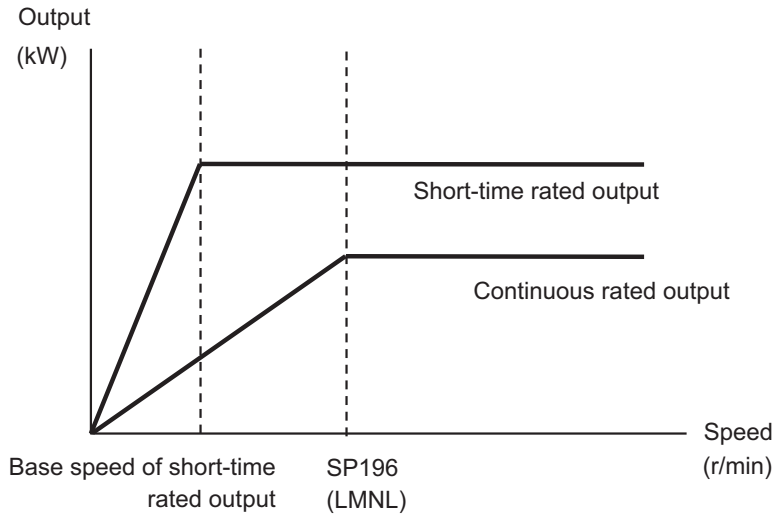

When "0" is set, the base speed of the short-time rated output will be applied.

(Note) When the speed is less than the base speed, the standard output to be displayed as 100% in load meter changes with the motor speed.

**---Setting range---**

0 to 32767 (r/min)

<b>#13197-13198</b>	<b>SP197-SP198</b>	
---------------------	--------------------	--

Not used. Set to "0".



**#13199      SP199 RTGM      Real-time tuning: maximum adaptive gain multiplier**

In case that machine resonance is induced when mounting a workpiece, the speed loop gain is switched automatically in response to inertia by setting the speed loop gain and workpiece inertia multiplier in advance.

The speed loop gain SP199(RTGM) changes in response to the estimated inertia ratio SP200(RTJX) based on the speed loop gain SP005(VGN1) and the inertia multiplier SP037(JL) which were adjusted when no workpiece was mounted.

When SP199 is set to "0", the adaptation of the speed loop gain will be disabled.

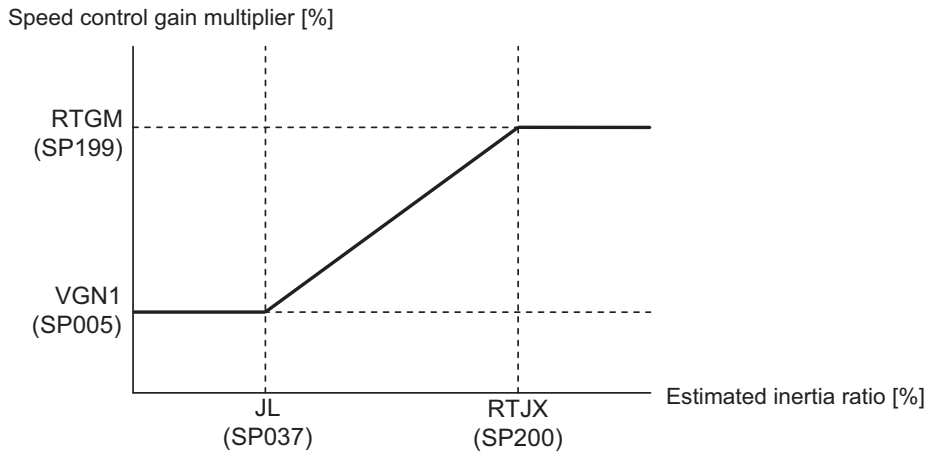

Related parameters: SP005, SP037, SP200

**---Setting range---**  
0 to 5000 (%)

**#13200      SP200 RTJX      Real-time tuning: maximum adaptive inertia ratio**

In case that machine resonance is induced when mounting a workpiece, the speed loop gain is switched automatically in response to inertia by setting the speed loop gain and workpiece inertia multiplier in advance.

The speed loop gain SP199(RTGM) changes in response to the estimated inertia ratio SP200(RTJX) based on the speed loop gain SP005(VGN1) and the inertia multiplier SP037(JL) which were adjusted when no workpiece was mounted.

When SP199 is set to "0", the adaptation of the speed loop gain will be disabled.

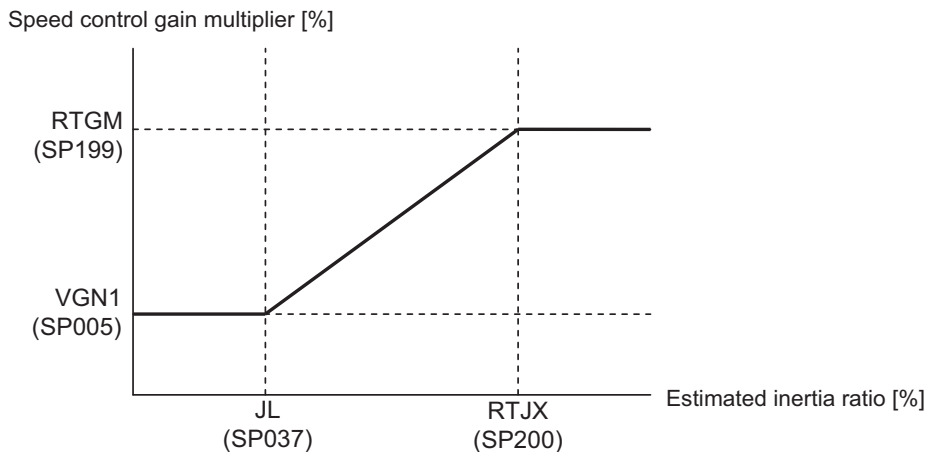

Related parameters: SP005, SP037, SP199

**---Setting range---**  
0 to 32767 (%)

#13201-13224	SP201-SP224
Not used. Set to "0".	
#13225	SP225 SFNC5
<b>Spindle function 5</b>	

Select the spindle functions.  
 Functions are allocated to each bit.  
 Set this in hexadecimal format.

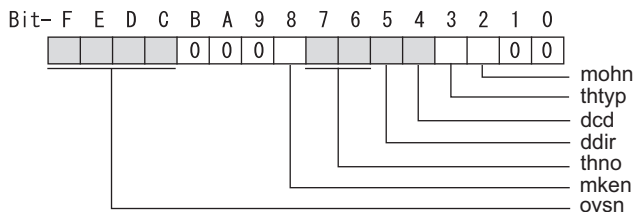

**bit F-C: ovsn Overshooting compensation type 3 non-sensitive band**

Set the non-sensitive band of the overshooting compensation type 3 in increments of 2°/1000.  
 In the feed forward control, set the non-sensitive band for the model position droop and ignore the model overshooting. Set to "2°/1000" as a standard.

**bit B-9:**

Not used. Set to "0".

**bit 8: mken Coil switch allowance in deceleration control**

This enables a coil changeover while decelerating after an emergency stop for a spindle motor with coil changeover specification. A coil changeover may enable an excessive load inertia to stop within the maximum delay time.

0: Normal (Disable)

1: Enable

**bit 7-6: thno**

Select the thermistor characteristics.  
 When SP225/bit3=0 (N type) is selected  
 bit7,6=  
 00: For Mitsubishi spindle motor  
 01: Setting prohibited  
 10: Setting prohibited  
 11: Setting prohibited  
 When SP225/bit3=1 (P type) is selected  
 bit7,6=  
 00: KTY84-130 (Manufactured by Philips)  
 01: Setting prohibited  
 10: Pt1000 (Platinum resistance temperature detector)  
 11: Setting prohibited

**bit 5: ddir Proximity switch signal enable edge**

0: Falling edge 1: Rising edge

**bit 4: dcd DC excitation mode**

0: Normal 1: Start

**bit 3: thtyp**

Select the thermistor type.  
 0: Type N thermistor (Mitsubishi Electric standard)  
 1: Type P thermistor or platinum resistance temperature detector

**bit 2: mohn Thermistor temperature detection**

0: Normal 1: Disable (Except for TS5690/5691)

**bit 1-0:**

Not used. Set to "0".

<b>#13226</b>	<b>SP226 SFNC6</b>	<b>Spindle function 6</b>
---------------	--------------------	---------------------------

Select the spindle functions.  
 Functions are allocated to each bit.  
 Set this in hexadecimal format.

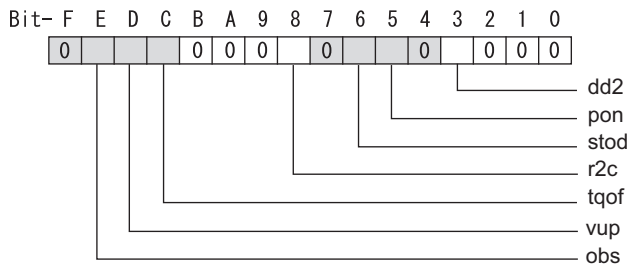

**bit F :**

Not used. Set to "0".

**bit E : obs Disturbance observer**

0: Normal 1: Enable

**bit D : vup High response acceleration / deceleration**

This suppresses a temporal delay which occurs when the target speed is attained from acceleration and when the spindle stops from deceleration.

0: Normal acceleration/deceleration 1: High response acceleration/deceleration Enable

**bit C : tqof Spindle output stabilization during acceleration**

0: Normal 1: Disable

**bit B-9 :**

Not used. Set to "0".

**bit 8 : r2c Temperature compensation adjustment indicator**

0: Normal 1: Display

**bit 7 :**

Not used. Set to "0".

**bit 6 : stod 4D-2 detection disabled during deceleration and stop**

0: Normal 1: Alarm 4D-2 detection disabled during deceleration and stop

**bit 5 : pon IPM spindle pulse application magnetic pole estimation**

0: Normal 1: Enable

**bit 4 :**

Not used. Set to "0".

**bit 3 : dd2 High-speed synchronous tapping 2**

0: Normal 1: Enable

**bit 2-0 :**

Not used. Set to "0".

#13227	SP227 SFNC7	Spindle function 7																
<p>Select the spindle functions.                      Functions are allocated to each bit.                      Set this in hexadecimal format.</p>																		
<p>Bit- F E D C B A 9 8 7 6 5 4 3 2 1 0</p> <table border="1" style="margin-left: 40px;"> <tr> <td style="width: 20px; height: 20px;"></td> <td style="width: 20px; height: 20px;"></td> <td style="width: 20px; height: 20px;"></td> <td style="width: 20px; height: 20px;"></td> <td style="width: 20px; height: 20px;"></td> <td style="width: 20px; height: 20px;"></td> <td style="width: 20px; height: 20px; text-align: center;">0</td> <td style="width: 20px; height: 20px; text-align: center;">0</td> <td style="width: 20px; height: 20px; text-align: center;">0</td> <td style="width: 20px; height: 20px; text-align: center;">0</td> <td style="width: 20px; height: 20px; text-align: center;">0</td> <td style="width: 20px; height: 20px; text-align: center;">0</td> <td style="width: 20px; height: 20px; text-align: center;">0</td> <td style="width: 20px; height: 20px; text-align: center;">0</td> <td style="width: 20px; height: 20px; text-align: center;">0</td> <td style="width: 20px; height: 20px; text-align: center;">0</td> </tr> </table>									0	0	0	0	0	0	0	0	0	0
						0	0	0	0	0	0	0	0	0	0			
<p><b>bit F-C : dis Digital signal input selection</b></p> <p>0: No signal                      4: Proximity switch signal detection                      Other settings: setting prohibited</p>																		
<p><b>bit B-A : dos3 Digital signal output 3 selection (MDS-EJ-SP/SP2)</b></p> <p>bitB,A=                      00: Disable                      01: Setting prohibited                      10: Contactor control signal output                      11: Setting prohibited</p>																		
<p><b>bit 9-3 :</b></p> <p>Not used. Set to "0".</p>																		
<p><b>bit 2 : ccu Lost motion/overshoot compensation compensation amount setting unit</b></p> <p>0: Short-time rated %    1: Short-time rated 0.01%</p>																		
<p><b>bit 1-0 :</b></p> <p>Not used. Set to "0".</p>																		
#13228	SP228 SFNC8	Spindle function 8																
<p>Not used. Set to "0000".</p>																		

**#13229      SP229 SFNC9      Spindle function 9**

Select the spindle functions.  
 Functions are allocated to each bit.  
 Set this in hexadecimal format.

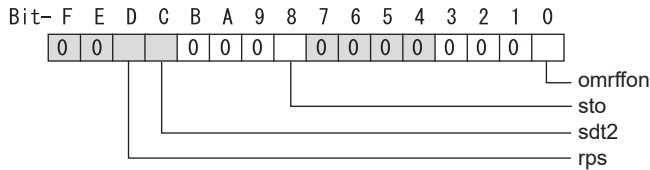

**bit F-E :**

Not used. Set to "0".

**bit D : rps Safely limited speed setting unit**

0: Normal 1: 100°/min

**bit C : sdt2 Specified speed output digital signal 2 output**

0: Normal 1: Enable

**bit B-9 :**

Not used. Set to "0".

**bit 8 : sto Dedicated wiring STO function**

Set this parameter to use dedicated wiring STO function.  
 0: Dedicated wiring STO function unused 1: Dedicated wiring STO function used  
 (Only for MDS-E/EH and MDS-EJ/EJH)

**bit 7-1 :**

Not used. Set to "0".

**bit 0 : omrffon OMR-FF control enabled**

0: Disable 1: Enable

**#13230      SP230 SFNC10      Spindle function 10**

Select the spindle functions.  
 Functions are allocated to each bit.  
 Set this in hexadecimal format.

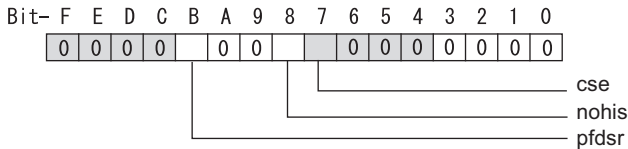

**bit F-C :**

Not used. Set to "0".

**bit B : pfdsr**

Set the spindle stop operation at a power failure when the deceleration and stop function at power failure is enabled.  
 Normal (Coast to a stop at power failure) : 0  
 Deceleration and stop at power failure : 1

**bit A-9 :**

Not used. Set to "0".

**bit 8 : nohis History of communication error alarm between NC and DRV(34,36,38,39)**

0: Enable 1: Disable

**bit 7 : cse Spindle C axis command speed monitoring function**

0: Normal setting (function disabled) 1: Function enabled

**bit 6-0 :**

Not used. Set to "0".

Related parameters: SP055, SP056

	<b>#13231</b>	<b>SP231</b>	
	<b>bit 3-0 : Sensitivity of estimated resonance frequency</b>		
	Set the sensitivity of the estimated resonance frequency. Smaller setting value enables to detect smaller vibration component 0: Normal setting 1: Sensitivity high to F: Sensitivity low.		
	<b>#13232</b>	<b>SP232</b>	
	Not used. Set to "0000".		
	<b>#13233</b>	<b>SP233 IVC</b>	<b>Voltage non-sensitive band compensation</b>
	When 100% is set, the voltage equivalent to the logical non-energized time will be compensated. When "0" is set, 100% compensation will be performed. Adjust in increments of 10% from the default value 100%. If the value is too large, vibration or vibration noise may be generated.		
	<b>---Setting range---</b>		
	0 to 255 (%)		
	<b>#13234</b>	<b>SP234</b>	
	Not used. Set to "0".		
<b>(PR)</b>	<b>#13235</b>	<b>SP235 R2H</b>	<b>Temperature compensation gain</b>
	Set the magnification in converting the thermistor temperature to the control compensation amount. When "0" is set, the temperature compensation function is disabled. When not using, or when using an IPM spindle motor, set to "0".		
	<b>---Setting range---</b>		
	0 to 400 (%)		
<b>(PR)</b>	<b>#13236</b>	<b>SP236 WIH</b>	<b>Temperature compensation time constant</b>
	Set the delay time constant from the thermistor temperature to the control compensation amount. When "0" is set, the delay time constant is disabled. When not using, or when using an IPM spindle motor, set to "0".		
	<b>---Setting range---</b>		
	0 to 150 (min)		
<b>(PR)</b>	<b>#13237</b>	<b>SP237 TCF</b>	<b>Torque command filter</b>
	Set the filter for the torque command. The standard value is "500".		
	<b>---Setting range---</b>		
	0 to 5000 (rad/s)		
	<b>#13238</b>	<b>SP238 SSCFEED</b>	<b>Safely limited speed</b>
	Set the safely limited speed at the spindle end for the SLS (Safely Limited Speed) function. When not using, set to "0".		
	<b>---Setting range---</b>		
	0 to 18000 (°/min)		
	However, when SP229/bitD is set to "1", the setting range is from -32768 to 32767 (100°/min).		

---

<b>#13239</b>	<b>SP239 SSCRPM</b>	<b>Safely limited motor speed</b>
---------------	---------------------	-----------------------------------

---

Set the motor's safely limited speed for the SLS (Safely Limited Speed) function.  
 When not using, set to "0".

**---Setting range---**

0 to 32767 (r/min)

(Note) The value of the safely limited speed and safely limited motor speed must satisfy the following relation. If this relation is not satisfied, the parameter error (37 or E4) will occur. (Error parameter No. is 239.)  
 Checking this relation is executed when the drive unit is turned ON and parameter is changed and speed observation mode (states when a speed observation command is turned ON) is entered.

$$\frac{\text{SP238 :SSCFEED}}{360} \times \frac{\text{SP057 :GRA1}}{\text{SP061 :GRB1}} = \text{SP239 :SSCRPM}$$

Note that "1 (r/min)" is applied when the calculation result is "0 (r/min)"

---

<b>(PR)</b>	<b>#13240</b>	<b>SP240</b>
-------------	---------------	--------------

---

Not used. Set to "0".

---

<b>(PR)</b>	<b>#13241- 13256</b>	<b>SP241-SP256</b>
-------------	--------------------------	--------------------

---

This is automatically set by the NC system.

## 16.10 Spindle-type Servo Parameters

#52001	SVSPEC	Spindle-mode servo: Specification
		[Exclusive for spindle-mode servo motor]
		<b>bit0: Selection of position loop gain when C axis is selected</b>
		0: Use the position loop gain (#52203 SV003, #52204 SV004, #52257 SV057)
		1: Use the spindle sync control position loop gain (#52249 SV049, #52250 SV050, #52258 SV058)
		<b>bit1: Selection of sync tap cycle position loop gain</b>
		0: Use the position loop gain (#52203 SV003, #52204 SV004, #52257 SV057)
		1: Use the spindle sync control position loop gain (#52249 SV049, #52250 SV050, #52258 SV058)
		<b>---Setting range---</b>
		00 to FFFF (HEX)
#52002	svzsp	Spindle-mode servo: Motor zero speed
		[Exclusive for spindle-mode servo motor]
		Specify the motor rotation speed at which zero speed detection is carried out. When the actual motor speed drops to the specified speed or below, the zero speed detection signal turns ON. The standard setting value is "50". When the setting value is "0", it is on the standard setting value.
		<b>---Setting range---</b>
		0 to 1000 (r/min)
#52003	svsdt	Spindle-mode servo: Speed detection set value
		[Exclusive for spindle-mode servo motor]
		Specify the motor speed at which speed detection is carried out. When the actual motor speed drops to the specified speed or below, the speed detection signal turns ON. The standard setting value is 10% of the "#3001 slimt1" setting value. When the setting value is "0", it is on the standard setting value.
		<b>---Setting range---</b>
		0 to 32767(r/min)
#52004	svtlm1	Spindle-mode servo: Torque limit 1
		[Exclusive for spindle-mode servo motor]
		Specify the torque limit value to be applied when Torque limit (Control input 1/bitA,9,8)=001.
		<b>---Setting range---</b>
		0 to 999 (Short-time rated %)
#52005	svtlm2	Spindle-mode servo: Torque limit 2
		[Exclusive for spindle-mode servo motor]
		Specify the torque limit value to be applied when Torque limit (Control input 1/bitA,9,8)=010.
		<b>---Setting range---</b>
		0 to 999 (Short-time rated %)
#52006	svtlm3	Spindle-mode servo: Torque limit 3
		[Exclusive for spindle-mode servo motor]
		Specify the torque limit value to be applied when Torque limit (Control input 1/bitA,9,8)=011.
		<b>---Setting range---</b>
		0 to 999 (Short-time rated %)
#52201-52456	SV001-SV256	Spindle-type Servo Parameters
		The description and setting range for these parameters are the same as Servo parameters "SV001" to "SV256". Refer to "Servo Parameters" for details.
		(Note) Set the same value to #52203 SV003(PGN) for the reference and synchronized spindles in spindle synchronization.



## 16.11 Rotary Axis Configuration Parameters

<b>(PR)</b>	<b>#7900</b>	<b>RCDAX_I</b>	<b>Orthogonal coordinate horizontal axis name</b>
			Set the name of the horizontal axis in the orthogonal coordinate system. Set "0" when horizontal axis is not used.
			<b>---Setting range---</b> A,B,C,U,V,W,X,Y,Z Two digits between A to Z and 1 to 9 0: Mechanical axis specifications
<b>(PR)</b>	<b>#7901</b>	<b>RCDAX_J</b>	<b>Orthogonal coordinate vertical axis name</b>
			Set the name of the vertical axis in the orthogonal coordinate system. Set "0" when vertical axis is not used.
			<b>---Setting range---</b> A,B,C,U,V,W,X,Y,Z Two digits between A to Z and 1 to 9 0: Mechanical axis specifications
<b>(PR)</b>	<b>#7902</b>	<b>RCDAX_K</b>	<b>Orthogonal coordinate height axis name</b>
			Set the name of the height axis in the orthogonal coordinate system. Set "0" when height axis is not used.
			<b>---Setting range---</b> A,B,C,U,V,W,X,Y,Z Two digits between A to Z and 1 to 9 0: Mechanical axis specifications
	<b>#7903</b>	<b>G92_CRD</b>	<b>Origin zero set coordinate selection</b>
			Select the coordinate to preset when issuing an origin zero command (G92X_Y_Z;). 0: Tool center coordinate 1: Holder center coordinate
	<b>#7904</b>	<b>NO_TIP</b>	<b>Tool handle feed function selection</b>
			Not used. Set to "0".
	<b>#7905</b>	<b>NO_ABS</b>	<b>Selection of tool axis travel amount display at manual ABS switch ON/OFF</b>
			Select how to update the display of tool axis travel amount. 0: Update at ABS switch OFF 1: Update at every ON and OFF of ABS switch
	<b>#7906</b>	<b>PASSTYP</b>	<b>Singular point passage type</b>
			Select the movement after passing a singular point. 0: Type 1 A/B axis rotation angle will be in the same sign direction as that when the tool center point control started. 1: Type 2 C axis rotation amount on the singular point will be smaller.
	<b>#7907</b>	<b>CHK_ANG</b>	<b>Near singular judgment angle</b>
			Set the angle for judging a position near the singular point. When "0.000" is set, it will operate as 1.000 (°).
			<b>---Setting range---</b> 0.000 to 5.000 (°)
	<b>#7908</b>	<b>SLCT_PRG_COORD</b>	<b>Programming coordinate system selection</b>
			Select the coordinate system for the programming coordinate. 0: Table coordinate system (coordinate system that rotates together with workpiece) 1: Workpiece coordinate system

#7909	IJK_VEC_MR	Posture vector mirror image selection
	Select whether to enable the mirror image on the posture vector (IJK) when Type 2 is selected in "#7906 PASSTYP".	
	0: Disable	
	1: Enable	
#7910	SLCT_INT_MODE	Interpolation method selection
	Select the interpolation method.	
	When combining spline interpolation 2 and tool center point control, only the joint interpolation method is valid.	
	0: Joint interpolation method	
	1: Single axis rotation interpolation method	
#7911	SLCT_STANDARD_POS	Reference position of rotary axis
	Select the reference point of the rotary axis.	
	0: The workpiece coordinate origin	
	1: The position at the time when tool center point command is issued	
	(Note) Even if the position is changed, it is not changed during tool center point control. It is changed when next tool center point control will be commanded.	
#7912	NO_MANUAL	Selection of 3-dimensional manual feed
	Select whether to enable the 3-dimensional manual feed	
	0: Enable (3-dimensional manual feed)	
	1: Disable (standard manual feed)	
#7913	MCHN_SPEED_CTRL	Machine speed fluctuation suppression
	Select whether to suppress the machine speed fluctuation due to rotary axis movement.	
	0: Not suppress	
	1: Suppress	
	(Note) This parameter is disabled when SSS control is enabled.	
#7914	ROT_PREFILT	Rotary axis prefilter time constant
	Not used. Set to "0".	
#7915	SLCT_SLOPE_CRD_MOD	Rotary axis basic position in inclined surface machining
	Set the basic position of rotary axis to establish the feature coordinate system when inclined surface machining is commanded.	
	* The position will not change when inclined surface machining is running. It will change when the next inclined surface machining is commanded.	
	0: At zero degree	
	1: At the start position	
#7916	ROT_ERR_MODE	Rotation center error compensation method
	Not used.	
(PR) #7917	SLCT_G53_6_ROTAX	G53.6 rotary axes rotation order
	Specify in which order to rotate the rotary axes when the address Q is unspecified in G53.6 and when the number of simultaneous contour control axes is limited to 4.	
	0: In the order of primary and secondary rotary axes	
	1: In the order of secondary and primary rotary axes	

<b>(PR)</b>	<b>#7920</b>	<b>SLCT_T1</b>	<b>Rotary axis selection</b>
			Select in which axis direction to rotate the base-side rotary axis of the rotary head. When the base-side rotary axis is tilting, use the tens place to select the axis around which the rotary axis is tilted. 0: Invalid 1: I axis 2: J axis 3: K axis 1x: Tilted around I axis 2x: Tilted around J axis 3x: Tilted around K axis (Note) A value from 0 to 99 can be set from the screen. However when an invalid value is set, the operation error (M01 0127) occurs at the power ON. <b>---Setting range---</b> 0 to 3 12, 13, 21, 23, 31, 32
<b>(PR)</b>	<b>#7921</b>	<b>TIANGT1</b>	<b>Tilt angle</b>
			Set the tilt angle if the base-side rotary axis of the rotary head is tilted. Set the angle with the CCW direction of the tilted plane being defined as the positive direction. <b>---Setting range---</b> -359.999 to 359.999 (°) (Follow as "#1003 iunit Input setup unit".)
<b>(PR)</b>	<b>#7922</b>	<b>ROTAXT1</b>	<b>Rotary axis name</b>
			Set the name of the tool rotating type base-side rotary axis. <b>---Setting range---</b> A,B,C,U,V,W,X,Y,Z Two digits between A to Z and 1 to 9 0: Mechanical axis specifications
	<b>#7924</b>	<b>COFST1H</b>	<b>Horizontal axis rotation center offset</b>
			Set the distance in the horizontal axis direction between the rotation centers of the tool-side rotary axis and the base-side rotary axis. <b>---Setting range---</b> -99999.999 to 99999.999 (mm)
	<b>#7925</b>	<b>COFST1V</b>	<b>Vertical axis rotation center offset</b>
			Set the distance in the vertical axis direction between the rotation centers of the tool-side rotary axis and the base-side rotary axis. <b>---Setting range---</b> -99999.999 to 99999.999 (mm)
	<b>#7926</b>	<b>COFST1T</b>	<b>Height axis rotation center offset</b>
			Set the distance in the height axis direction between the rotation centers of the tool-side rotary axis and the base-side rotary axis. <b>---Setting range---</b> -99999.999 to 99999.999 (mm)
	<b>#7927</b>	<b>CERRT1H</b>	<b>Horizontal axis rotation center error compensation amount</b>
			Not used. Set to "0.000".
	<b>#7928</b>	<b>CERRT1V</b>	<b>Vertical axis rotation center error compensation amount</b>
			Not used. Set to "0.000".

<b>(PR)</b>	<b>#7930</b>	<b>LCT_T2</b>	<b>Rotary axis selection</b>
			Select in which axis direction to rotate the tool-side rotary axis of the rotary head. When the tool-side rotary axis is tilting, use the tens place to select the axis around which the rotary axis is tilted. 0: Invalid 1: I axis 2: J axis 3: K axis 1x: Tilted around I axis 2x: Tilted around J axis 3x: Tilted around K axis (Note) A value from 0 to 99 can be set from the screen. However when an invalid value is set, the operation error (M01 0127) occurs at the power ON. <b>---Setting range---</b> 0 to 3 12, 13, 21, 23, 31, 32
<b>(PR)</b>	<b>#7931</b>	<b>TIANGT2</b>	<b>Tilt angle</b>
			Set the tilt angle if the tool-side rotary axis of the rotary head is tilted. Set the angle with the CCW direction of the tilted plane being defined as the positive direction. <b>---Setting range---</b> -359.999 to 359.999 (°) (Follow as "#1003 iunit Input setup unit".)
<b>(PR)</b>	<b>#7932</b>	<b>ROTAXT2</b>	<b>Rotary axis name</b>
			Set the name of the tool rotating type tool-side rotary axis. <b>---Setting range---</b> A,B,C,U,V,W,X,Y,Z Two digits between A to Z and 1 to 9 0: Mechanical axis specifications
	<b>#7934</b>	<b>COFST2H</b>	<b>Horizontal axis rotation center offset</b>
			Set the distance in the horizontal axis direction between the spindle holder center and the rotation center of the tool-side rotary axis. <b>---Setting range---</b> -99999.999 to 99999.999 (mm)
	<b>#7935</b>	<b>COFST2V</b>	<b>Vertical axis rotation center offset</b>
			Set the distance in the vertical axis direction between the spindle holder center and the rotation center of the tool-side rotary axis. <b>---Setting range---</b> -99999.999 to 99999.999 (mm)
	<b>#7936</b>	<b>COFST2T</b>	<b>Height axis rotation center offset</b>
			Set the distance in the height axis direction between the spindle holder center and the rotation center of the tool-side rotary axis. <b>---Setting range---</b> -99999.999 to 99999.999 (mm)
	<b>#7937</b>	<b>CERRT2H</b>	<b>Horizontal axis rotation center error compensation amount</b>
			Not used. Set to "0.000".
	<b>#7938</b>	<b>CERRT2V</b>	<b>Vertical axis rotation center error compensation amount</b>
			Not used. Set to "0.000".

<b>(PR)</b>	<b>#7940</b>	<b>SLCT_W1</b>	<b>Rotary axis selection</b>
			Select in which axis direction to rotate the base-side rotary axis of the rotary table. When the base-side rotary axis is tilting, use the tens place to select the axis around which the rotary axis is tilted. 0: Invalid 1: I axis 2: J axis 3: K axis 1x: Tilted around I axis 2x: Tilted around J axis 3x: Tilted around K axis (Note) A value from 0 to 99 can be set from the screen. However when an invalid value is set, the operation error (M01 0127) occurs at the power ON. <b>---Setting range---</b> 0 to 3 12, 13, 21, 23, 31, 32
<b>(PR)</b>	<b>#7941</b>	<b>TIANGW1</b>	<b>Tilt angle</b>
			Set the tilt angle if the base-side rotary axis of the rotary table is tilted. Set the angle with the CCW direction of the tilted plane being defined as the negative direction. <b>---Setting range---</b> -359.999 to 359.999 (°) (Follow as "#1003 iunit" (Input setup unit).)
<b>(PR)</b>	<b>#7942</b>	<b>ROTAXW1</b>	<b>Rotary axis name</b>
			Set the name of the table rotating type base-side rotary axis. <b>---Setting range---</b> A,B,C,U,V,W,X,Y,Z Two digits between A to Z and 1 to 9 0: Mechanical axis specifications
	<b>#7944</b>	<b>COFSW1H</b>	<b>Horizontal axis rotation center offset</b>
			When all axes are at the machine zero point, set the distance in the horizontal axis direction from the machine zero point to the rotation center of the base-side rotary axis. <b>---Setting range---</b> -99999.999 to 99999.999 (mm)
	<b>#7945</b>	<b>COFSW1V</b>	<b>Vertical axis rotation center offset</b>
			When all axes are at the machine zero point, set the distance in the vertical axis direction from the machine zero point to the rotation center of the base-side rotary axis. <b>---Setting range---</b> -99999.999 to 99999.999 (mm)
	<b>#7946</b>	<b>COFSW1T</b>	<b>Height axis rotation center offset</b>
			When all axes are at the machine zero point, set the distance in the height axis direction from the machine zero point to the rotation center of the base-side rotary axis. <b>---Setting range---</b> -99999.999 to 99999.999 (mm)
	<b>#7947</b>	<b>CERRW1H</b>	<b>Horizontal axis rotation center error compensation amount</b>
			Not used. Set to "0.000".
	<b>#7948</b>	<b>CERRW1V</b>	<b>Vertical axis rotation center error compensation amount</b>
			Not used. Set to "0.000".

<b>(PR)</b>	<b>#7950</b>	<b>SLCT_W2</b>	<b>Rotary axis selection</b>
			Select in which axis direction to rotate the workpiece-side rotary axis of the rotary table. When the workpiece-side rotary axis is tilting, use the tens place to select the axis around which the rotary axis is tilted. 0: Invalid 1: I axis 2: J axis 3: K axis 1x: Tilted around I axis 2x: Tilted around J axis 3x: Tilted around K axis (Note) A value from 0 to 99 can be set from the screen. However when an invalid value is set, the operation error (M01 0127) occurs at the power ON. <b>---Setting range---</b> 0 to 3 12, 13, 21, 23, 31, 32
<b>(PR)</b>	<b>#7951</b>	<b>TIANGW2</b>	<b>Tilt angle</b>
			Set the tilt angle if the workpiece-side rotary axis of the rotary table is tilted. Set the angle with the CCW direction of the tilted plane being defined as the negative direction. <b>---Setting range---</b> -359.999 to 359.999 (°) (Follow as "#1003 iunit" (Input setup unit).)
<b>(PR)</b>	<b>#7952</b>	<b>ROTAXW2</b>	<b>Rotary axis name</b>
			Set the name of the table rotating type workpiece-side rotary axis. <b>---Setting range---</b> A,B,C,U,V,W,X,Y,Z Two digits between A to Z and 1 to 9 0: Mechanical axis specifications
	<b>#7954</b>	<b>COFSW2H</b>	<b>Horizontal axis rotation center offset</b>
			When all axes are at the machine zero point, set the distance in the horizontal axis direction between rotation centers of the base-side rotary axis and the workpiece-side rotary axis. <b>---Setting range---</b> -99999.999 to 99999.999 (mm)
	<b>#7955</b>	<b>COFSW2V</b>	<b>Vertical axis rotation center offset</b>
			When all axes are at the machine zero point, set the distance in the vertical axis direction between rotation centers of the base-side rotary axis and the workpiece-side rotary axis. <b>---Setting range---</b> -99999.999 to 99999.999 (mm)
	<b>#7956</b>	<b>COFSW2T</b>	<b>Height axis rotation center offset</b>
			When all axes are at the machine zero point, set the distance in the height axis direction between rotation centers of the base-side rotary axis and the workpiece-side rotary axis. <b>---Setting range---</b> -99999.999 to 99999.999 (mm)
	<b>#7957</b>	<b>CERRW2H</b>	<b>Horizontal axis rotation center error compensation amount</b>
			Not used. Set to "0.000".
	<b>#7958</b>	<b>CERRW2V</b>	<b>Vertical axis rotation center error compensation amount</b>
			Not used. Set to "0.000".

<b>#7960</b>	<b>Rot1 Ang Geo Dev1</b>	<b>Angular deviation 1 of center line of 1st rotary axis</b>
When 1st rotary axis is I axis rotation, set the angular deviation of J axis rotation. When 1st rotary axis is J axis rotation, set the angular deviation of K axis rotation. When 1st rotary axis is K axis rotation, set the angular deviation of I axis rotation.		
<b>---Setting range---</b>		
-1.000000 to 1.000000 (deg)		
<b>#7961</b>	<b>Rot1 Ang Geo Dev2</b>	<b>Angular deviation 2 of center line of 1st rotary axis</b>
When 1st rotary axis is I axis rotation, set the angular deviation of K axis rotation. When 1st rotary axis is J axis rotation, set the angular deviation of I axis rotation. When 1st rotary axis is K axis rotation, set the angular deviation of J axis rotation.		
<b>---Setting range---</b>		
-1.000000 to 1.000000 (deg)		
<b>#7962</b>	<b>Rot2 Ang Geo Dev1</b>	<b>Angular deviation 1 of center line of 2nd rotary axis</b>
When 2nd rotary axis is I axis rotation, set the angular deviation of J axis rotation. When 2nd rotary axis is J axis rotation, set the angular deviation of K axis rotation. When 2nd rotary axis is K axis rotation, set the angular deviation of I axis rotation.		
<b>---Setting range---</b>		
-1.000000 to 1.000000 (deg)		
<b>#7963</b>	<b>Rot2 Ang Geo Dev2</b>	<b>Angular deviation 2 of center line of 2nd rotary axis</b>
When 2nd rotary axis is I axis rotation, set the angular deviation of K axis rotation. When 2nd rotary axis is J axis rotation, set the angular deviation of I axis rotation. When 2nd rotary axis is K axis rotation, set the angular deviation of J axis rotation.		
<b>---Setting range---</b>		
-1.000000 to 1.000000 (deg)		

## 16.12 PLC Timer

---

#16000- 16703	T0 - T703	PLC timer <10ms/100ms>
------------------	-----------	------------------------

---

Not used.



## 16.13 PLC Integrated Timer

---

#17000- 17063	ST0 - ST63	PLC integrated timer <100ms INC.>
------------------	------------	-----------------------------------

---

Not used.

## 16.14 PLC Counter

---

#17200- 17455	C000 - C255	Counter
------------------	-------------	---------

---

Not used.

## 16.15 PLC Constants

#18001- 18150	R7500,7501 - R7798,7799	PLC constant (Base area)
		<p>Set the value to be set in the data type R register used in the PLC program (ladder). Even if the data is set in the R register that corresponds to the PLC side when this parameter is displayed, the screen will not change. Enter a different screen once, and then select this screen again.</p> <p><b>---Setting range---</b></p> <p>-2 to the power of 31 to 2 to the power of 31 -1</p>
#18151- 18900	R8300,8301 - R9798,9799	PLC constant (Extension area)
		Not used. Set to "0".

## 16.16 PLC Bit Selection

(Note) Even if the data is set in the R register(R7800 to R7897) that corresponds to the PLC side when this parameter is displayed, the screen will not change. Enter a different screen once, and then select this screen again. #6449 to #6496 are PLC operation parameters used by MITSUBISHI.

Refer to "PLC Development Manual" and "PLC Programming Manual" for details.

#6401-6448	R7800-Low - R7823-High	Bit selection
These bit type parameters are used in the user PLC (ladder).		
#6449	R7824-Low	Bit selection
bit7: Control unit thermal alarm valid		
bit6: Setting and display unit thermal management valid (This function may not be available for some NC models.)		
bit5: Set to "0".		
bit4: Battery alarm/warning detection disabled		
(Note) When the parameter is set to "1", the "Battery alarm" signal and the "Battery warning" signal will not be turned ON, and the alarm messages will not be displayed.		
bit3-0: Set to "0".		
#6450	R7824-High	Bit selection
bit7: Set to "0".		
bit6: External alarm message display (This function may not be available for some NC models.)		
bit5: Alarm/operator change (This function may not be available for some NC models.)		
bit4: Full screen display of message (This function may not be available for some NC models.)		
bit3: Set to "0".		
bit2: Operator message valid		
bit1: Not used. Set to "0".		
bit0: Not used. Set to "0".		
#6451	R7825-Low	Bit selection
bit7-4: Set to "0".		
bit3: Select the key input switch setting.		
0: Key code is processed without going through the sequence program.		
1: Key code is processed through the sequence program.		
(Note) When this parameter is 1, key data is set in KEYOUT(R212) through a sequence program, and is enabled. Even if the key data is not changed through a sequence program, make sure to loop-back the key data read from KEYIN(R8) of the NC to R212 of the PLC. Without this loop-back, the key becomes disabled.		
bit2-0: Set to "0".		
#6452	R7825-High	Bit selection
bit7: Set to "0".		
bit6: Branch destination label check valid		
bit5: Set to "0".		
bit4: Not used. Set to "0".		
bit3-0: Set to "0".		
#6453	R7826-Low	Bit selection
bit7-0: Set to "0".		
#6454	R7826-High	Bit selection
bit7-0: Set to "0".		
#6455	R7827-Low	Bit selection
bit7: Enable ladder program writing during RUN		
bit6: Enable ladder program writing during RUN (in high-speed processing)		
bit5-3: Set to "0".		
bit2-0: R device access variables decimal point valid region		

<b>#6456</b>	<b>R7827-High</b>	<b>Bit selection</b>
bit7-5: Set to "0".		
bit4: Motor insulation deterioration detection ON		
bit3: Motor insulation deterioration warning ON		
bit2-0: Set to "0".		
<b>#6457-6458</b>	<b>R7828-Low - R7828-High</b>	<b>Bit selection</b>
High-speed input specification 1		
<b>#6459-6460</b>	<b>R7829-Low - R7829-High</b>	<b>Bit selection</b>
High-speed input specification 2		
<b>#6461-6462</b>	<b>R7830-Low - R7830-High</b>	<b>Bit selection</b>
High-speed output specification 1		
<b>#6463-6464</b>	<b>R7831-Low - R7831-High</b>	<b>Bit selection</b>
High-speed output specification 2		
<b>#6465-6466</b>	<b>R7832-Low - R7832-High</b>	<b>Bit selection</b>
High-speed input specification 3		
<b>#6467-6468</b>	<b>R7833-Low - R7833-High</b>	<b>Bit selection</b>
High-speed input specification 4		
<b>#6469-6470</b>	<b>R7834-Low - R7834-High</b>	<b>Bit selection</b>
Set to "0".		
<b>#6471</b>	<b>R7835-Low</b>	<b>Bit selection</b>
bit7-1: Set to "0".		
bit0: ERROR LED display		
Select the display specifications of ERROR LED (red) when only minor errors occur.		
0: Turning OFF when only minor errors occur.		
1: Turning ON when only minor errors occur.		
<b>#6472</b>	<b>R7835-High</b>	<b>Bit selection</b>
Set to "0".		
<b>#6473-6474</b>	<b>R7836-Low - R7836-High</b>	<b>Bit selection</b>
High-speed output specification 3		
<b>#6475-6476</b>	<b>R7837-Low - R7837-High</b>	<b>Bit selection</b>
High-speed output specification 4		
<b>#6477-6480</b>	<b>R7838-Low - R7839-High</b>	<b>Bit selection</b>
Set to "0".		
<b>#6481-6496</b>	<b>R7840-Low - R7847-High</b>	<b>Bit selection</b>
This is reserved for debugging by MITSUBISHI. Set to "0".		
<b>#6497-6596</b>	<b>R7848-Low - R7897-High</b>	<b>Bit selection</b>
These bit type parameters are used in the user PLC (ladder).		

## 16.17 Machine Error Compensation Parameters

(PR)	#4000	Pinc	Machine error compensation increment method
			Select the method to set the machine error compensation data. 0: Absolute amount method 1: Incremental amount method
#4001	cmpax		Base axis <n-th axis>
			Set a name of the basic axis for machine error compensation. (1) For pitch error compensation, set the name of the axis to be compensated. (2) For relative position compensation, set the name of the axis to be the basic axis. Set "system No. + axis name" when using the multi-part system. (Example) Z axis for 2nd part system: 2Z  When two or more same name exist, set "axis name + serial number". The serial number is common to all systems. (Example) If C axis of the 1st system has 2 axes, and another C axis in the 2nd system has 1 axis, set the C axis of the 2nd system as "C3". <b>---Setting range---</b> Abbreviation as X, Y, Z, U, V, W, A, B, C, etc.
#4002	drcax		Compensation axis <n-th axis>
			Set a name of the compensation axis for machine error compensation. (1) For pitch error compensation, set the same axis name as in "#4001 cmpax". (2) For relative position compensation, set the name of the axis to be actually compensated. Set "system No. + axis name" when using the multi-part system. (Example) Z axis for 2nd part system: 2Z  When two or more same name exist, set "axis name + serial number". The serial number is common to all systems. (Example) If C axis of the 1st system has 2 axes, and another C axis in the 2nd system has 1 axis, set the C axis of the 2nd system as "C3". <b>---Setting range---</b> Abbreviation as X, Y, Z, U, V, W, A, B, C, etc.
#4003	rdvno		Division point number at reference position <n-th axis>
			Set the compensation data No. corresponding to the reference position. As the reference position is actually the base position, there is no compensation No. Therefore set the number that is decremented by 1. (Note) When bidirectional pitch error compensation is enabled, set compensation data No. corresponding to reference point in shifting in plus direction. <b>---Setting range---</b> 4101 to 5124
#4004	mdvno		Division point number at the most negative side <n-th axis>
			Set the compensation data No. at the farthest end on the negative side. (Note) When the axis moves in positive direction with bidirectional pitch error compensation enabled, set compensation data No. of which locates on the nearest point to negative side. The compensation point should be set with even number. <b>---Setting range---</b> 4101 to 5124

<b>#4005</b>	<b>pdvno</b>	<b>Division point number at the most positive side &lt;n-th axis&gt;</b>
<p>Set the compensation data No. at the farthest end on the positive side.</p> <p>(Note) When the axis moves in negative direction with bidirectional pitch error compensation enabled, set compensation data No. of which locates on the nearest point to positive side. The compensation point should be set with even number.</p> <p>---Setting range---</p> <p>4101 to 5124</p>		
<b>#4006</b>	<b>sc</b>	<b>Compensation scale factor &lt;n-th axis&gt;</b>
<p>Set the scale factor for the compensation amount.</p> <p>---Setting range---</p> <p>0 to 99</p>		
<b>#4007</b>	<b>spcdv</b>	<b>Division interval &lt;n-th axis&gt;</b>
<p>Set the interval to divide the basic axis.</p> <p>Each compensation data will be the compensation amount for each of these intervals.</p> <p>---Setting range---</p> <p>0.001 to 9999.999 (mm)</p>		
<b>#4008</b>	<b>twopc</b>	<b>Bidirectional pitch error compensation &lt;n-th axis&gt;</b>
<p>Select whether to enable bidirectional pitch error compensation.</p> <p>0: Disable</p> <p>1: Enable</p>		
<b>#4009</b>	<b>refcmp</b>	<b>Reference position compensation amount &lt;n-th axis&gt;</b>
<p>When bidirectional pitch error compensation is enabled, set the compensation amount of the reference position when the axis moves to the position from the opposite direction of the zero point return.</p> <p>(Note) The actual compensation amount will be the value obtained by multiplying the setting value with the compensation scale.</p> <p>---Setting range---</p> <p>-32768 to 32767</p>		
<b>#4101-5999</b>		
<p>Set the compensation amount for each axis.</p> <p>(Note) The actual compensation amount will be the value obtained by multiplying the setting value with the compensation scale.</p> <p>---Setting range---</p> <p>-32768 to 32767</p>		

## 16.18 Macro List

<b>#7001</b>	<b>M[01] Code</b>
Set the M code used for calling out the macro with the M command.	
Select codes to be entered other than the codes basically required by the machine and M codes of M0, M1, M2, M30, M96 through M99, and M198.	
This is valid when "#1195 Mmac" is set to "1".	
<b>---Setting range---</b>	
0 to 9999	
<b>#7002</b>	<b>M[01] TYPE</b>
Specify the macro call type.	
0: Equivalent to M98 P****;	
1: Equivalent to G65 P****;	
2: Equivalent to G66 P****;	
3: Equivalent to G66.1 P****;	
4: Equivalent to G144 D0 A****; (Sub part system control II complete wait method)	
5: Equivalent to G144 D1 A****; (Sub part system control II parallel process method)	
<b>#7003</b>	<b>M[01] Program No.</b>
Set the No. of the program or file name to be called out. The file name can contain up to 32 characters.	
<b>---Setting range---</b>	
Program name or file name (up to 32 characters)	
<b>#7011</b>	<b>M[02] Code</b>
The setting method is same as "#7001".	
<b>#7012</b>	<b>M[02] Type</b>
The setting method is same as "#7002".	
<b>#7013</b>	<b>M[02] Program No.</b>
The setting method is same as "#7003".	
<b>#7021</b>	<b>M[03] Code</b>
The setting method is same as "#7001".	
<b>#7022</b>	<b>M[03] Type</b>
The setting method is same as "#7002".	
<b>#7023</b>	<b>M[03] Program No.</b>
The setting method is same as "#7003".	
<b>#7031</b>	<b>M[04] Code</b>
The setting method is same as "#7001".	
<b>#7032</b>	<b>M[04] Type</b>
The setting method is same as "#7002".	
<b>#7033</b>	<b>M[04] Program No.</b>
The setting method is same as "#7003".	
<b>#7041</b>	<b>M[05] Code</b>
The setting method is same as "#7001".	
<b>#7042</b>	<b>M[05] Type</b>
The setting method is same as "#7002".	
<b>#7043</b>	<b>M[05] Program No.</b>
The setting method is same as "#7003".	
<b>#7051</b>	<b>M[06] Code</b>
The setting method is same as "#7001".	



<b>#7052</b>	<b>M[06] Type</b>
	The setting method is same as "#7002".
<b>#7053</b>	<b>M[06] Program No.</b>
	The setting method is same as "#7003".
<b>#7061</b>	<b>M[07] Code</b>
	The setting method is same as "#7001".
<b>#7062</b>	<b>M[07] Type</b>
	The setting method is same as "#7002".
<b>#7063</b>	<b>M[07] Program No.</b>
	The setting method is same as "#7003".
<b>#7071</b>	<b>M[08] Code</b>
	The setting method is same as "#7001".
<b>#7072</b>	<b>M[08] Type</b>
	The setting method is same as "#7002".
<b>#7073</b>	<b>M[08] Program No.</b>
	The setting method is same as "#7003".
<b>#7081</b>	<b>M[09] Code</b>
	The setting method is same as "#7001".
<b>#7082</b>	<b>M[09] Type</b>
	The setting method is same as "#7002".
<b>#7083</b>	<b>M[09] Program No.</b>
	The setting method is same as "#7003".
<b>#7091</b>	<b>M[10] Code</b>
	The setting method is same as "#7001".
<b>#7092</b>	<b>M[10] Type</b>
	The setting method is same as "#7002".
<b>#7093</b>	<b>M[10] Program No.</b>
	The setting method is same as "#7003".
<b>#7102</b>	<b>M2mac Type</b>
	Set the type for when calling out the macro with the 2nd miscellaneous command. The macro will be called out with the "#1170 M2name" address command when "#1198 M2mac" is set to "1". The setting method is same as "M call macro".
	<b>---Setting range---</b>
	0 to 3
<b>#7103</b>	<b>M2mac Program No.</b>
	Set the program No. for when calling out the macro with the 2nd miscellaneous command. The macro will be called out with the "#1170 M2name" address command when "#1198 M2mac" is set to "1". The setting method is same as "M call macro".
	<b>---Setting range---</b>
	Program name or file name (up to 32 characters)
<b>#7201</b>	<b>G[01] Code</b>
	Set the G code to be used when calling the macro with a G command. Do not set a G code used in the system. G101 to G110 and G200 to G202 are user macro I codes. However, if a parameter is set for the G code call code, the G code call will have the priority, and these cannot be used as the user macro I.
	<b>---Setting range---</b>
	1 to 999

<b>#7202</b>	<b>G[01] Type</b>
	Specify the macro call type. 0: Equivalent to M98 P****; 1: Equivalent to G65 P****; 2: Equivalent to G66 P****; 3: Equivalent to G66.1 P****; <b>---Setting range---</b> 0 to 3
<b>#7203</b>	<b>G[01] Program No.</b>
	Set the No. of the program or file name to be called out. The file name can contain up to 32 characters. <b>---Setting range---</b> Program name or file name (up to 32 characters)
<b>#7211</b>	<b>G[02] Code</b>
	The setting method is same as "#7201".
<b>#7212</b>	<b>G[02] Type</b>
	The setting method is same as "#7202".
<b>#7213</b>	<b>G[02] Program No.</b>
	The setting method is same as "#7203".
<b>#7221</b>	<b>G[03] Code</b>
	The setting method is same as "#7201".
<b>#7222</b>	<b>G[03] Type</b>
	The setting method is same as "#7202".
<b>#7223</b>	<b>G[03] Program No.</b>
	The setting method is same as "#7203".
<b>#7231</b>	<b>G[04] Code</b>
	The setting method is same as "#7201".
<b>#7232</b>	<b>G[04] Type</b>
	The setting method is same as "#7202".
<b>#7233</b>	<b>G[04] Program No.</b>
	The setting method is same as "#7203".
<b>#7241</b>	<b>G[05] Code</b>
	The setting method is same as "#7201".
<b>#7242</b>	<b>G[05] Type</b>
	The setting method is same as "#7202".
<b>#7243</b>	<b>G[05] Program No.</b>
	The setting method is same as "#7203".
<b>#7251</b>	<b>G[06] Code</b>
	The setting method is same as "#7201".
<b>#7252</b>	<b>G[06] Type</b>
	The setting method is same as "#7202".
<b>#7253</b>	<b>G[06] Program No.</b>
	The setting method is same as "#7203".
<b>#7261</b>	<b>G[07] Code</b>
	The setting method is same as "#7201".
<b>#7262</b>	<b>G[07] Type</b>
	The setting method is same as "#7202".

<b>#7263</b>	<b>G[07] Program No.</b>
	The setting method is same as "#7203".
<b>#7271</b>	<b>G[08] Code</b>
	The setting method is same as "#7201".
<b>#7272</b>	<b>G[08] Type</b>
	The setting method is same as "#7202".
<b>#7273</b>	<b>G[08] Program No.</b>
	The setting method is same as "#7203".
<b>#7281</b>	<b>G[09] Code</b>
	The setting method is same as "#7201".
<b>#7282</b>	<b>G[09] Type</b>
	The setting method is same as "#7202".
<b>#7283</b>	<b>G[09] Program No.</b>
	The setting method is same as "#7203".
<b>#7291</b>	<b>G[10] Code</b>
	The setting method is same as "#7201".
<b>#7292</b>	<b>G[10] Type</b>
	The setting method is same as "#7202".
<b>#7293</b>	<b>G[10] Program No.</b>
	The setting method is same as "#7203".
<b>#7302</b>	<b>Smac Type</b>
	Set the type No. for when calling the macro with an S command. This is valid when "#1196 Smac" is set to "1". The setting method is same as "M call macro".
	<b>---Setting range---</b>
	0 to 3
<b>#7303</b>	<b>Smac Program No.</b>
	Set the program No. for when calling the macro with an S command. This is valid when "#1196 Smac" is set to "1". The setting method is same as "M call macro".
	<b>---Setting range---</b>
	Program name or file name (up to 32 characters)
<b>#7312</b>	<b>Tmac Type</b>
	Set the type for when calling the macro with a T command. This is valid when "#1197 Tmac" is set to "1". The setting method is same as "M call macro".
	<b>---Setting range---</b>
	0 to 3
<b>#7313</b>	<b>Tmac Program No.</b>
	Set the program No. for when calling the macro with a T command. This is valid when "#1197 Tmac" is set to "1". The setting method is same as "M call macro".
	<b>---Setting range---</b>
	Program name or file name (up to 32 characters)

<b>#7322</b>	<b>G200 type</b>
	Specify the macro call type. 0: Equivalent to M98P P****; 1: Equivalent to G65P P****; 2: Equivalent to G66P P****; 3: Equivalent to G66.1P P****; <b>---Setting range---</b> 0 to 3
<b>#7323</b>	<b>G200 program No.</b>
	Specify the figures in the hundreds and higher places of the macro program No. to be called. <b>---Setting range---</b> 90 to 99, or 1000100 to 1999999  (Note) To set the program No. to "1000100 to 1999999", set the macro call out type to 0 (M98) or 1 (G65).
<b>#7332</b>	<b>G300 type</b>
	The setting method is same as "#7322".
<b>#7333</b>	<b>G300 program No.</b>
	The setting method is same as "#7323".
<b>#7342</b>	<b>G400 type</b>
	The setting method is same as "#7322".
<b>#7343</b>	<b>G400 program No.</b>
	The setting method is same as "#7323".
<b>#7352</b>	<b>G500 type</b>
	The setting method is same as "#7322".
<b>#7353</b>	<b>G500 program No.</b>
	The setting method is same as "#7323".
<b>#7362</b>	<b>G600 type</b>
	The setting method is same as "#7322".
<b>#7363</b>	<b>G600 program No.</b>
	The setting method is same as "#7323".
<b>#7372</b>	<b>G700 type</b>
	The setting method is same as "#7322".
<b>#7373</b>	<b>G700 program No.</b>
	The setting method is same as "#7323".
<b>#7382</b>	<b>G800 type</b>
	The setting method is same as "#7322".
<b>#7383</b>	<b>G800 program No.</b>
	The setting method is same as "#7323".
<b>#7392</b>	<b>G900 type</b>
	The setting method is same as "#7322".
<b>#7393</b>	<b>G900 program No.</b>
	The setting method is same as "#7323".
<b>#7401</b>	<b>ASCII[01] Valid</b>
	The ASCII code macro parameters (#7402 to 7405) are validated. 0: Disable 1: Enable

<b>#7402</b>	<b>ASCII[01] Code</b>
Set the ASCII code used to call macros with the ASCII code. L system: A,B,D,F,H,I,J,K,M,Q,R,S,T M system: A,B,F,H,I,K,M,Q,R,S,T	
<b>#7403</b>	<b>ASCII[01] Type</b>
Set the macro call type. 0: M98 1: G65 2: G66 3: G66.1	
<b>#7404</b>	<b>ASCII[01] Program No.</b>
Set the program No. called with macro call. ---Setting range--- Program name or file name (up to 32 characters)	
<b>#7405</b>	<b>ASCII[01] Variable</b>
When the call type is "0", set the variable No. set after the ASCII code. ---Setting range--- 100 to 149	
<b>#7411</b>	<b>ASCII[02] Valid</b>
The ASCII code macro parameters (#7412 to 7415) are validated. 0: Disable 1: Enable	
<b>#7412</b>	<b>ASCII[02] Code</b>
Set the ASCII code used to call macros with the ASCII code. L system: A,B,D,F,H,I,J,K,M,Q,R,S,T M system: A,B,F,H,I,K,M,Q,R,S,T	
<b>#7413</b>	<b>ASCII[02] Type</b>
Set the macro call type. 0: M98 1: G65 2: G66 3: G66.1	
<b>#7414</b>	<b>ASCII[02] Program No.</b>
Set the program No. called with macro call. ---Setting range--- Program name or file name (up to 32 characters)	
<b>#7415</b>	<b>ASCII[02] Variable</b>
When the call type is "0", set the variable No. set after the ASCII code. ---Setting range--- 100 to 149	

## 16.19 Position Switches

(Note) The parameters #7741 to #7814 (position switch No. 25 to 32) are only for C80.

#7500	Pcheck	High-speed switching of position switch
		Specify whether to perform position switch area checking at high speeds. 0: Do not perform position switch area checking at high speed (do it the same as before). 1: Perform position switch area checking at high speed. For C80, whether the setting is "0" or "1", the operation of "1" is always performed.
#7501+10(n-1)	PSWn axis	Axis name
		"n" represents the position switch No. (n=1 to 24) Specify the name of the axis for which a position switch is provided. ---Setting range--- NC axis: the NC axis address such as X, Y, Z, U, V PLC axis: the PLC axis No. such as 1, 2, 3, 4, 5, 6, 7, 8
#7502+10(n-1)	PSWn dog1	Imaginary dog position 1
		"n" represents the position switch No. (n=1 to 24) When the machine enters the range between imaginary dog positions 1 and 2, a signal is output to the PLC. For the device No., refer to "PLC Interface Manual". ---Setting range--- -99999.999 to 99999.999 (mm)
#7503+10(n-1)	PSWn dog2	Imaginary dog position 2
		"n" represents the position switch No. (n=1 to 24) When the machine enters the range between imaginary dog positions 1 and 2, a signal is output to the PLC. For the device No., refer to "PLC Interface Manual". ---Setting range--- -99999.999 to 99999.999 (mm)
#7504+10(n-1)	PSWn check	Selection of area check method
		"n" represents the PS position switch No. (n=1 to 24) When position switch area checking at high speed is selected, specify the mode of area checking, i.e., whether to use the command type machine position or encoder feedback position, for each position switch. 0: Use the command type machine position as the machine position for position switch area checking. 1: Use the encoder feedback position as the machine position for position switch area checking.
#7741+10(n-25)	PSWn axis	Axis name
		"n" represents the position switch No. (n=25 to 32) Specify the name of the axis for which a position switch is provided. ---Setting range--- PLC axis: the PLC axis No. such as 1, 2, 3, 4, 5, 6, 7, 8
#7742+10(n-25)	PSWn dog1	Imaginary dog position 1
		"n" represents the position switch No. (n=25 to 32) When the machine enters the range between imaginary dog positions 1 and 2, a signal is output to the PLC. For the device No., refer to the PLC Interface Manual. ---Setting range--- -99999.999 to 99999.999 (mm)
#7743+10(n-25)	PSWn dog2	Imaginary dog position 2
		"n" represents the position switch No. (n=25 to 32) When the machine enters the range between imaginary dog positions 1 and 2, a signal is output to the PLC. For the device No., refer to the PLC Interface Manual. ---Setting range--- -99999.999 to 99999.999 (mm)

#7744+10(n-25)	PSWn check	Selection of area check method
		"n" represents the position switch No. (n=25 to 32) When position switch area checking at high speed is selected, specify the mode of area checking, i.e., whether to use the command type machine position or encoder feedback position, for each position switch. 0: Use the command type machine position as the machine position for position switch area checking. 1: Use the encoder feedback position as the machine position for position switch area checking.

## 16.20 Open Parameters

---

<b>#29001- 29896</b>	<b>Open param 1</b>
--------------------------	---------------------

---

Set LONG data.

#29001 to #29896 are used as parameter range where C language modules can be used arbitrarily.

---

<b>#29901- 29996</b>	<b>Open param 2</b>
--------------------------	---------------------

---

Set DOUBLE data.

#29901 to #29996 are used as parameter range where C language modules can be used arbitrarily.



## 16.21 PLC Axis Indexing Parameters

(PR)	#12800	chgauxno	Auxiliary axis number
Set the axis No. to be controlled as auxiliary axis using auxiliary axis interface. When "0" is set, the axis will not operate as auxiliary axis.			
---Setting range---			
0 to 8			
(PR)	#12801	aux_station	Number of indexing stations
Set the number of stations. For linear axis, this value is expressed by: number of divisions = number of stations -1. Setting "0" or "1" sets the number of stations to 2.			
---Setting range---			
0 to 360			
(PR)	#12802	aux_Cont1	Control parameter 1
The bits that are not explained here must be set to "0".			
<b>bit3:</b>			
0: Automatic reach signal isn't interlocked with the start signal.			
1: Automatic reach signal is interlocked with the start signal.			
<b>bit4:</b>			
0: Automatic reach signal is turned ON again.			
1: Automatic reach signal isn't turned ON again.			
<b>bit5:</b>			
0: Station No. Output within fixed position.			
1: Station No. Constantly output.			
<b>bit9:</b>			
0: Rotation direction determined by operation control signal (DIR)			
1: Rotation direction in the shortcut direction			
<b>bitE:</b>			
0: Rotation direction in operation control signal (DIR) or in the shortcut direction			
1: Rotation direction in the arbitrary position command sign direction			
<b>bitF:</b>			
0: Stopper direction is in the positioning direction.			
1: Stopper direction is in the sign direction of the stopper amount.			
(PR)	#12803	aux_Cont2	Control parameter 2
The bits that are not explained here must be set to "0".			
<b>bit4:</b>			
0: Uniform assignment			
1: Arbitrary coordinate assignment			
(PR)	#12804	aux_tleng	Linear axis stroke length
Set the movement stroke length for linear axes. (Note 1) Setting "0.000" causes an MCP alarm at the power ON. (Note 2) This parameter is meaningless at the non-uniform index or random position command.			
---Setting range---			
0.000 to 99999.999 (mm)			
	#12805	aux_ST.offset	Station offset
Set the distance (offset) from the reference position to station 1.			
---Setting range---			
-99999.999 to 99999.999 (° or mm)			

<b>#12810+10(n-1)</b>	<b>aux_Aspeedn</b>	<b>Operation parameter group n Automatic operation speed</b>
<p>Set the feedrate during automatic operation when "operation parameter group n" is selected.</p> <p>"#12810 aux_Aspeed1" is regarded as the clamp value for the automatic operation speeds and manual operation speeds of all operation groups.</p> <p>A speed exceeding "aux_Aspeed1" cannot be commanded, even if it is set in a parameter.</p> <p>(Note) Setting "0" causes an operation error at the "Operation start" signal's ON.</p> <p><b>---Setting range---</b></p> <p>0 to 100000 (°/min or mm/min)</p>		
<b>#12811+10(n-1)</b>	<b>aux_Mspeedn</b>	<b>Operation parameter group n Manual operation speed</b>
<p>Set the feedrate during manual operation or JOG operation when "operation parameter group n" is selected.</p> <p>(Note) Setting "0" causes an operation error at the "Operation start" signal's ON.</p> <p><b>---Setting range---</b></p> <p>0 to 100000 (°/min or mm/min)</p>		
<b>#12812+10(n-1)</b>	<b>aux_timen.1</b>	<b>Operation parameter group n Acceleration/deceleration time constant 1</b>
<p>Set the linear acceleration/deceleration time for "Operation parameter group 1 automatic operation speed" (clamp speed) when "operation parameter group n" is selected.</p> <p>When "#12818+10(n-1) aux_smgstn" is "F", S-shape acceleration/deceleration is carried out.</p> <p>When operating at a speed less than the clamp speed, if "#1361 aux_acc" is set to "0", the axis will accelerate/decelerate with the time constant set in this parameter. If "#1361 aux_acc" is set to "1", the axis will accelerate/decelerate at the constant inclination determined by this parameter and "aux_Aspeed1".</p> <p>Setting "0" cancels acceleration/deceleration: The axis will move with the time constant "0".</p> <p><b>---Setting range---</b></p> <p>0 to 4000 (ms)</p>		
<b>#12813+10(n-1)</b>	<b>aux_timen.2</b>	<b>Operation parameter group n Acceleration/deceleration time constant 2</b>
<p>Set the total time of the non-linear parts in the S-pattern acceleration/deceleration.</p> <p>In the handle feed operation mode, this setting value is regarded as time constant for the linear acceleration/deceleration.</p> <p>(Note) If this parameter is set to "0" while "#12818 aux_smgst1" is set to "F", an MCP alarm will occur.</p> <p><b>---Setting range---</b></p> <p>0 to 4000 (ms)</p>		
<b>#12814+10(n-1)</b>	<b>aux_TLn</b>	<b>Operation parameter group n Torque limit value</b>
<p>Set the motor output torque limit value when "operation parameter group n" is selected.</p> <p>When setting 500%, the torque is limited at the maximum torque of the motor specifications. Set 500%, when torque is not particularly needed to be limited.</p> <p>In the stopper positioning operation mode, this will be regarded as torque limit value when positioning to the stopper starting coordinates.</p> <p><b>---Setting range---</b></p> <p>0 to 500 (%)</p>		
<b>#12815+10(n-1)</b>	<b>aux_ODn</b>	<b>Operation parameter group n Excessive error detection width</b>
<p>Set the excessive error detection width when "operation parameter group n" is selected.</p> <p>The excessive error alarm (S03 0052) will be detected when the position droop becomes larger than this setting value.</p> <p>In the stopper positioning operation mode, this will be regarded as excessive error detection width when positioning to the stopper starting coordinates.</p> <p><b>---Setting range---</b></p> <p>0 to 32767(° or mm)</p>		

	<b>#12816+10(n-1)</b>	<b>aux_justn</b>	<b>Operation parameter group n Set position output width</b>
			<p>Set the tolerable value at which "set position reached" (JST) or "automatic set position reached" (JSTA) signal is output when "operation parameter group n" is selected.</p> <p>"Set position reached" (JST) indicates that the machine position is at any station.</p> <p>During automatic operation, "automatic set position reached" (JSTA) is also output under the same condition. These signals will turn OFF when the machine position moves away from the station over this value.</p> <p><b>---Setting range---</b></p> <p>0.000 to 99999.999 (° or mm)</p>
	<b>#12817+10(n-1)</b>	<b>aux_nearn</b>	<b>Operation parameter group n Near set position output width</b>
			<p>Set the tolerable value at which "near set position" (NEAR) signal is output when "operation parameter group n" is selected.</p> <p>"Near set position" (NEAR) indicates that the machine position is near any station position. This value is generally set wider than the set position output width.</p> <p>During operations, this is related to the special commands when the station selection is set to "0".</p> <p><b>---Setting range---</b></p> <p>0.000 to 99999.999 (° or mm)</p>
<b>(PR)</b>	<b>#12818+10(n-1)</b>	<b>aux_smgstn</b>	<b>Operation parameter group n Acceleration/Deceleration type</b>
			<p>Select the acceleration/deceleration type when "operation parameter group n" is selected.</p> <p>0, 1: Linear acceleration/deceleration</p> <p>F: S-pattern acceleration/deceleration</p>
	<b>#12850</b>	<b>aux_stpos2</b>	<b>Station 2 coordinate</b>
			<p>Set the station 2 coordinate value when arbitrary coordinate assignment is selected.</p> <p>The station 1 coordinate value is fixed at "0.000" (machine coordinate zero point).</p> <p><b>---Setting range---</b></p> <p>-99999.999 to 99999.999 (° or mm)</p>
	<b>#12851</b>	<b>aux_stpos3</b>	<b>Station 3 coordinate</b>
			<p>Set the station 3 coordinate value when arbitrary coordinate assignment is selected.</p> <p>The station 1 coordinate value is fixed at "0.000" (machine coordinate zero point).</p> <p><b>---Setting range---</b></p> <p>-99999.999 to 99999.999 (° or mm)</p>
	<b>#12852</b>	<b>aux_stpos4</b>	<b>Station 4 coordinate</b>
			<p>Set the station 4 coordinate value when arbitrary coordinate assignment is selected.</p> <p>The station 1 coordinate value is fixed at "0.000" (machine coordinate zero point).</p> <p><b>---Setting range---</b></p> <p>-99999.999 to 99999.999 (° or mm)</p>
	<b>#12853</b>	<b>aux_stpos5</b>	<b>Station 5 coordinate</b>
			<p>Set the station 5 coordinate value when arbitrary coordinate assignment is selected.</p> <p>The station 1 coordinate value is fixed at "0.000" (machine coordinate zero point).</p> <p><b>---Setting range---</b></p> <p>-99999.999 to 99999.999 (° or mm)</p>
	<b>#12854</b>	<b>aux_stpos6</b>	<b>Station 6 coordinate</b>
			<p>Set the station 6 coordinate value when arbitrary coordinate assignment is selected.</p> <p>The station 1 coordinate value is fixed at "0.000" (machine coordinate zero point).</p> <p><b>---Setting range---</b></p> <p>-99999.999 to 99999.999 (° or mm)</p>

<b>#12855</b>	<b>aux_stpos7</b>	<b>Station 7 coordinate</b>
Set the station 7 coordinate value when arbitrary coordinate assignment is selected. The station 1 coordinate value is fixed at "0.000" (machine coordinate zero point).		
<b>---Setting range---</b>		
-99999.999 to 99999.999 (° or mm)		
<b>#12856</b>	<b>aux_stpos8</b>	<b>Station 8 coordinate</b>
Set the station 8 coordinate value when arbitrary coordinate assignment is selected. The station 1 coordinate value is fixed at "0.000" (machine coordinate zero point).		
<b>---Setting range---</b>		
-99999.999 to 99999.999 (° or mm)		
<b>#12857</b>	<b>aux_stpos9</b>	<b>Station 9 coordinate</b>
Set the station 9 coordinate value when arbitrary coordinate assignment is selected. The station 1 coordinate value is fixed at "0.000" (machine coordinate zero point).		
<b>---Setting range---</b>		
-99999.999 to 99999.999 (° or mm)		
<b>#12858</b>	<b>aux_stpos10</b>	<b>Station 10 coordinate</b>
Set the station 10 coordinate value when arbitrary coordinate assignment is selected. The station 1 coordinate value is fixed at "0.000" (machine coordinate zero point).		
<b>---Setting range---</b>		
-99999.999 to 99999.999 (° or mm)		
<b>#12859</b>	<b>aux_stpos11</b>	<b>Station 11 coordinate</b>
Set the station 11 coordinate value when arbitrary coordinate assignment is selected. The station 1 coordinate value is fixed at "0.000" (machine coordinate zero point).		
<b>---Setting range---</b>		
-99999.999 to 99999.999 (° or mm)		
<b>#12860</b>	<b>aux_stpos12</b>	<b>Station 12 coordinate</b>
Set the station 12 coordinate value when arbitrary coordinate assignment is selected. The station 1 coordinate value is fixed at "0.000" (machine coordinate zero point).		
<b>---Setting range---</b>		
-99999.999 to 99999.999 (° or mm)		
<b>#12861</b>	<b>aux_stpos13</b>	<b>Station 13 coordinate</b>
Set the station 13 coordinate value when arbitrary coordinate assignment is selected. The station 1 coordinate value is fixed at "0.000" (machine coordinate zero point).		
<b>---Setting range---</b>		
-99999.999 to 99999.999 (° or mm)		
<b>#12862</b>	<b>aux_stpos14</b>	<b>Station 14 coordinate</b>
Set the station 14 coordinate value when arbitrary coordinate assignment is selected. The station 1 coordinate value is fixed at "0.000" (machine coordinate zero point).		
<b>---Setting range---</b>		
-99999.999 to 99999.999 (° or mm)		
<b>#12863</b>	<b>aux_stpos15</b>	<b>Station 15 coordinate</b>
Set the station 15 coordinate value when arbitrary coordinate assignment is selected. The station 1 coordinate value is fixed at "0.000" (machine coordinate zero point).		
<b>---Setting range---</b>		
-99999.999 to 99999.999 (° or mm)		

<b>#12864</b>	<b>aux_stpos16</b>	<b>Station 16 coordinate</b>
Set the station 16 coordinate value when arbitrary coordinate assignment is selected. The station 1 coordinate value is fixed at "0.000" (machine coordinate zero point).		
---Setting range---		
-99999.999 to 99999.999 (° or mm)		
<b>#12865</b>	<b>aux_stpos17</b>	<b>Station 17 coordinate</b>
Set the station 17 coordinate value when arbitrary coordinate assignment is selected. The station 1 coordinate value is fixed at "0.000" (machine coordinate zero point).		
---Setting range---		
-99999.999 to 99999.999 (° or mm)		
<b>#12866</b>	<b>aux_stpos18</b>	<b>Station 18 coordinate</b>
Set the station 18 coordinate value when arbitrary coordinate assignment is selected. The station 1 coordinate value is fixed at "0.000" (machine coordinate zero point).		
---Setting range---		
-99999.999 to 99999.999 (° or mm)		
<b>#12867</b>	<b>aux_stpos19</b>	<b>Station 19 coordinate</b>
Set the station 19 coordinate value when arbitrary coordinate assignment is selected. The station 1 coordinate value is fixed at "0.000" (machine coordinate zero point).		
---Setting range---		
-99999.999 to 99999.999 (° or mm)		
<b>#12868</b>	<b>aux_stpos20</b>	<b>Station 20 coordinate</b>
Set the station 20 coordinate value when arbitrary coordinate assignment is selected. The station 1 coordinate value is fixed at "0.000" (machine coordinate zero point).		
---Setting range---		
-99999.999 to 99999.999 (° or mm)		
<b>#12870</b>	<b>aux_PSWcheck</b>	<b>PSW detection method</b>
Select the criterion for the output of position switches 1 to 15. bit0 to E correspond to position switches 1 to 15. 0: Judged by the machine position of the command system. 1: Judged by the machine FB position (actual position).		
(Note) The bits that are not explained here must be set to "0".		
<b>#12871</b>	<b>aux_PSW1dog1</b>	<b>PSW1 area setting 1</b>
Set "PSW1 area setting" 1 and 2 to specify the area where the position switch 1 will turn ON when the machine is positioned. Whether the value of setting 1 is larger than setting 2 (or vice versa) does not affect the position switch operation. For rotary axes, the output turns ON in the area excluding 0.000 degree.		
---Setting range---		
-99999.999 to 99999.999 (° or mm)		
<b>#12872</b>	<b>aux_PSW1dog2</b>	<b>PSW1 area setting 2</b>
Set "PSW1 area setting" 1 and 2 to specify the area where the position switch 1 will turn ON when the machine is positioned. Whether the value of setting 1 is larger than setting 2 (or vice versa) does not affect the position switch operation. For rotary axes, the output turns ON in the area excluding 0.000 degree.		
---Setting range---		
-99999.999 to 99999.999 (° or mm)		

<b>#12873</b>	<b>aux_PSW2dog1</b>	<b>PSW2 area setting 1</b>
Set "PSW2 area setting" 1 and 2 to specify the area where the position switch 2 will turn ON when the machine is positioned.		
Whether the value of setting 1 is larger than setting 2 (or vice versa) does not affect the position switch operation.		
For rotary axes, the output turns ON in the area excluding 0.000 degree.		
<b>---Setting range---</b>		
-99999.999 to 99999.999 (° or mm)		
<b>#12874</b>	<b>aux_PSW2dog2</b>	<b>PSW2 area setting 2</b>
Set "PSW2 area setting" 1 and 2 to specify the area where the position switch 2 will turn ON when the machine is positioned.		
Whether the value of setting 1 is larger than setting 2 (or vice versa) does not affect the position switch operation.		
For rotary axes, the output turns ON in the area excluding 0.000 degree.		
<b>---Setting range---</b>		
-99999.999 to 99999.999 (° or mm)		
<b>#12875</b>	<b>aux_PSW3dog1</b>	<b>PSW3 area setting 1</b>
Set "PSW3 area setting" 1 and 2 to specify the area where the position switch 3 will turn ON when the machine is positioned.		
Whether the value of setting 1 is larger than setting 2 (or vice versa) does not affect the position switch operation.		
For rotary axes, the output turns ON in the area excluding 0.000 degree.		
<b>---Setting range---</b>		
-99999.999 to 99999.999 (° or mm)		
<b>#12876</b>	<b>aux_PSW3dog2</b>	<b>PSW3 area setting 2</b>
Set "PSW3 area setting" 1 and 2 to specify the area where the position switch 3 will turn ON when the machine is positioned.		
Whether the value of setting 1 is larger than setting 2 (or vice versa) does not affect the position switch operation.		
For rotary axes, the output turns ON in the area excluding 0.000 degree.		
<b>---Setting range---</b>		
-99999.999 to 99999.999 (° or mm)		
<b>#12877</b>	<b>aux_PSW4dog1</b>	<b>PSW4 area setting 1</b>
Set "PSW4 area setting" 1 and 2 to specify the area where the position switch 4 will turn ON when the machine is positioned.		
Whether the value of setting 1 is larger than setting 2 (or vice versa) does not affect the position switch operation.		
For rotary axes, the output turns ON in the area excluding 0.000 degree.		
<b>---Setting range---</b>		
-99999.999 to 99999.999 (° or mm)		
<b>#12878</b>	<b>aux_PSW4dog2</b>	<b>PSW4 area setting 2</b>
Set "PSW4 area setting" 1 and 2 to specify the area where the position switch 4 will turn ON when the machine is positioned.		
Whether the value of setting 1 is larger than setting 2 (or vice versa) does not affect the position switch operation.		
For rotary axes, the output turns ON in the area excluding 0.000 degree.		
<b>---Setting range---</b>		
-99999.999 to 99999.999 (° or mm)		

<b>#12879</b>	<b>aux_PSW5dog1</b>	<b>PSW5 area setting 1</b>
<p>Set "PSW5 area setting" 1 and 2 to specify the area where the position switch 5 will turn ON when the machine is positioned.</p> <p>Whether the value of setting 1 is larger than setting 2 (or vice versa) does not affect the position switch operation.</p> <p>For rotary axes, the output turns ON in the area excluding 0.000 degree.</p> <p><b>---Setting range---</b></p> <p>-99999.999 to 99999.999 (° or mm)</p>		
<b>#12880</b>	<b>aux_PSW5dog2</b>	<b>PSW5 area setting 2</b>
<p>Set "PSW5 area setting" 1 and 2 to specify the area where the position switch 5 will turn ON when the machine is positioned.</p> <p>Whether the value of setting 1 is larger than setting 2 (or vice versa) does not affect the position switch operation.</p> <p>For rotary axes, the output turns ON in the area excluding 0.000 degree.</p> <p><b>---Setting range---</b></p> <p>-99999.999 to 99999.999 (° or mm)</p>		
<b>#12881</b>	<b>aux_PSW6dog1</b>	<b>PSW6 area setting 1</b>
<p>Set "PSW6 area setting" 1 and 2 to specify the area where the position switch 6 will turn ON when the machine is positioned.</p> <p>Whether the value of setting 1 is larger than setting 2 (or vice versa) does not affect the position switch operation.</p> <p>For rotary axes, the output turns ON in the area excluding 0.000 degree.</p> <p><b>---Setting range---</b></p> <p>-99999.999 to 99999.999 (° or mm)</p>		
<b>#12882</b>	<b>aux_PSW6dog2</b>	<b>PSW6 area setting 2</b>
<p>Set "PSW6 area setting" 1 and 2 to specify the area where the position switch 6 will turn ON when the machine is positioned.</p> <p>Whether the value of setting 1 is larger than setting 2 (or vice versa) does not affect the position switch operation.</p> <p>For rotary axes, the output turns ON in the area excluding 0.000 degree.</p> <p><b>---Setting range---</b></p> <p>-99999.999 to 99999.999 (° or mm)</p>		
<b>#12883</b>	<b>aux_PSW7dog1</b>	<b>PSW7 area setting 1</b>
<p>Set "PSW7 area setting" 1 and 2 to specify the area where the position switch 7 will turn ON when the machine is positioned.</p> <p>Whether the value of setting 1 is larger than setting 2 (or vice versa) does not affect the position switch operation.</p> <p>For rotary axes, the output turns ON in the area excluding 0.000 degree.</p> <p><b>---Setting range---</b></p> <p>-99999.999 to 99999.999 (° or mm)</p>		
<b>#12884</b>	<b>aux_PSW7dog2</b>	<b>PSW7 area setting 2</b>
<p>Set "PSW7 area setting" 1 and 2 to specify the area where the position switch 7 will turn ON when the machine is positioned.</p> <p>Whether the value of setting 1 is larger than setting 2 (or vice versa) does not affect the position switch operation.</p> <p>For rotary axes, the output turns ON in the area excluding 0.000 degree.</p> <p><b>---Setting range---</b></p> <p>-99999.999 to 99999.999 (° or mm)</p>		

<b>#12885</b>	<b>aux_PSW8dog1</b>	<b>PSW8 area setting 1</b>
<p>Set "PSW8 area setting" 1 and 2 to specify the area where the position switch 8 will turn ON when the machine is positioned.</p> <p>Whether the value of setting 1 is larger than setting 2 (or vice versa) does not affect the position switch operation.</p> <p>For rotary axes, the output turns ON in the area excluding 0.000 degree.</p> <p><b>---Setting range---</b></p> <p>-99999.999 to 99999.999 (° or mm)</p>		
<b>#12886</b>	<b>aux_PSW8dog2</b>	<b>PSW8 area setting 2</b>
<p>Set "PSW8 area setting" 1 and 2 to specify the area where the position switch 8 will turn ON when the machine is positioned.</p> <p>Whether the value of setting 1 is larger than setting 2 (or vice versa) does not affect the position switch operation.</p> <p>For rotary axes, the output turns ON in the area excluding 0.000 degree.</p> <p><b>---Setting range---</b></p> <p>-99999.999 to 99999.999 (° or mm)</p>		
<b>#12887</b>	<b>aux_PSW9dog1</b>	<b>PSW9 area setting 1</b>
<p>Set "PSW9 area setting" 1 and 2 to specify the area where the position switch 9 will turn ON when the machine is positioned.</p> <p>Whether the value of setting 1 is larger than setting 2 (or vice versa) does not affect the position switch operation.</p> <p>For rotary axes, the output turns ON in the area excluding 0.000 degree.</p> <p><b>---Setting range---</b></p> <p>-99999.999 to 99999.999 (° or mm)</p>		
<b>#12888</b>	<b>aux_PSW9dog2</b>	<b>PSW9 area setting 2</b>
<p>Set "PSW9 area setting" 1 and 2 to specify the area where the position switch 9 will turn ON when the machine is positioned.</p> <p>Whether the value of setting 1 is larger than setting 2 (or vice versa) does not affect the position switch operation.</p> <p>For rotary axes, the output turns ON in the area excluding 0.000 degree.</p> <p><b>---Setting range---</b></p> <p>-99999.999 to 99999.999 (° or mm)</p>		
<b>#12889</b>	<b>aux_PSW10dog1</b>	<b>PSW10 area setting 1</b>
<p>Set "PSW10 area setting" 1 and 2 to specify the area where the position switch 10 will turn ON when the machine is positioned.</p> <p>Whether the value of setting 1 is larger than setting 2 (or vice versa) does not affect the position switch operation.</p> <p>For rotary axes, the output turns ON in the area excluding 0.000 degree.</p> <p><b>---Setting range---</b></p> <p>-99999.999 to 99999.999 (° or mm)</p>		
<b>#12890</b>	<b>aux_PSW10dog2</b>	<b>PSW10 area setting 2</b>
<p>Set "PSW10 area setting" 1 and 2 to specify the area where the position switch 10 will turn ON when the machine is positioned.</p> <p>Whether the value of setting 1 is larger than setting 2 (or vice versa) does not affect the position switch operation.</p> <p>For rotary axes, the output turns ON in the area excluding 0.000 degree.</p> <p><b>---Setting range---</b></p> <p>-99999.999 to 99999.999 (° or mm)</p>		



<b>#12891</b>	<b>aux_PSW11dog1</b>	<b>PSW11 area setting 1</b>
<p>Set "PSW11 area setting" 1 and 2 to specify the area where the position switch 11 will turn ON when the machine is positioned.</p> <p>Whether the value of setting 1 is larger than setting 2 (or vice versa) does not affect the position switch operation.</p> <p>For rotary axes, the output turns ON in the area excluding 0.000 degree.</p> <p><b>---Setting range---</b></p> <p>-99999.999 to 99999.999 (° or mm)</p>		
<b>#12892</b>	<b>aux_PSW11dog2</b>	<b>PSW11 area setting 2</b>
<p>Set "PSW11 area setting" 1 and 2 to specify the area where the position switch 11 will turn ON when the machine is positioned.</p> <p>Whether the value of setting 1 is larger than setting 2 (or vice versa) does not affect the position switch operation.</p> <p>For rotary axes, the output turns ON in the area excluding 0.000 degree.</p> <p><b>---Setting range---</b></p> <p>-99999.999 to 99999.999 (° or mm)</p>		
<b>#12893</b>	<b>aux_PSW12dog1</b>	<b>PSW12 area setting 1</b>
<p>Set "PSW12 area setting" 1 and 2 to specify the area where the position switch 12 will turn ON when the machine is positioned.</p> <p>Whether the value of setting 1 is larger than setting 2 (or vice versa) does not affect the position switch operation.</p> <p>For rotary axes, the output turns ON in the area excluding 0.000 degree.</p> <p><b>---Setting range---</b></p> <p>-99999.999 to 99999.999 (° or mm)</p>		
<b>#12894</b>	<b>aux_PSW12dog2</b>	<b>PSW12 area setting 2</b>
<p>Set "PSW12 area setting" 1 and 2 to specify the area where the position switch 12 will turn ON when the machine is positioned.</p> <p>Whether the value of setting 1 is larger than setting 2 (or vice versa) does not affect the position switch operation.</p> <p>For rotary axes, the output turns ON in the area excluding 0.000 degree.</p> <p><b>---Setting range---</b></p> <p>-99999.999 to 99999.999 (° or mm)</p>		
<b>#12895</b>	<b>aux_PSW13dog1</b>	<b>PSW13 area setting 1</b>
<p>Set "PSW13 area setting" 1 and 2 to specify the area where the position switch 13 will turn ON when the machine is positioned.</p> <p>Whether the value of setting 1 is larger than setting 2 (or vice versa) does not affect the position switch operation.</p> <p>For rotary axes, the output turns ON in the area excluding 0.000 degree.</p> <p><b>---Setting range---</b></p> <p>-99999.999 to 99999.999 (° or mm)</p>		
<b>#12896</b>	<b>aux_PSW13dog2</b>	<b>PSW13 area setting 2</b>
<p>Set "PSW13 area setting" 1 and 2 to specify the area where the position switch 13 will turn ON when the machine is positioned.</p> <p>Whether the value of setting 1 is larger than setting 2 (or vice versa) does not affect the position switch operation.</p> <p>For rotary axes, the output turns ON in the area excluding 0.000 degree.</p> <p><b>---Setting range---</b></p> <p>-99999.999 to 99999.999 (° or mm)</p>		

<b>#12897</b>	<b>aux_PSW14dog1</b>	<b>PSW14 area setting 1</b>
<p>Set "PSW14 area setting" 1 and 2 to specify the area where the position switch 14 will turn ON when the machine is positioned.</p> <p>Whether the value of setting 1 is larger than setting 2 (or vice versa) does not affect the position switch operation.</p> <p>For rotary axes, the output turns ON in the area excluding 0.000 degree.</p> <p><b>---Setting range---</b></p> <p>-99999.999 to 99999.999 (° or mm)</p>		
<b>#12898</b>	<b>aux_PSW14dog2</b>	<b>PSW14 area setting 2</b>
<p>Set "PSW14 area setting" 1 and 2 to specify the area where the position switch 14 will turn ON when the machine is positioned.</p> <p>Whether the value of setting 1 is larger than setting 2 (or vice versa) does not affect the position switch operation.</p> <p>For rotary axes, the output turns ON in the area excluding 0.000 degree.</p> <p><b>---Setting range---</b></p> <p>-99999.999 to 99999.999 (° or mm)</p>		
<b>#12899</b>	<b>aux_PSW15dog1</b>	<b>PSW15 area setting 1</b>
<p>Set "PSW15 area setting" 1 and 2 to specify the area where the position switch 15 will turn ON when the machine is positioned.</p> <p>Whether the value of setting 1 is larger than setting 2 (or vice versa) does not affect the position switch operation.</p> <p>For rotary axes, the output turns ON in the area excluding 0.000 degree.</p> <p><b>---Setting range---</b></p> <p>-99999.999 to 99999.999 (° or mm)</p>		
<b>#12900</b>	<b>aux_PSW15dog2</b>	<b>PSW15 area setting 2</b>
<p>Set "PSW15 area setting" 1 and 2 to specify the area where the position switch 15 will turn ON when the machine is positioned.</p> <p>Whether the value of setting 1 is larger than setting 2 (or vice versa) does not affect the position switch operation.</p> <p>For rotary axes, the output turns ON in the area excluding 0.000 degree.</p> <p><b>---Setting range---</b></p> <p>-99999.999 to 99999.999 (° or mm)</p>		
<b>#12910</b>	<b>aux_push</b>	<b>Stopper amount</b>
<p>Set the command stroke of the stopper operation in the stopper positioning.</p> <p><b>---Setting range---</b></p> <p>0.000 to 359.999(° or mm)</p>		
<b>#12911</b>	<b>aux_pusht1</b>	<b>Stopper standby time</b>
<p>Set the standby time from the stopper starting coordinate positioning to the stopper operation start in the stopper positioning.</p> <p><b>---Setting range---</b></p> <p>0 to 9999 (ms)</p>		
<b>#12912</b>	<b>aux_pusht2</b>	<b>Stopper torque release time</b>
<p>Set the time from the completion of the stopper operation to the changeover of the stopper torque in the stopper positioning.</p> <p><b>---Setting range---</b></p> <p>0 to 9999(ms)</p>		
<b>#12913</b>	<b>aux_pusht3</b>	<b>Set position signal output delay time</b>
<p>Set the time from the completion of the stopper operation to the output of the "automatic set position reached" (JSTA), "set position reached" (JST) or "near set position" (NEAR) signal in the stopper positioning.</p> <p><b>---Setting range---</b></p> <p>0 to 9999(ms)</p>		

## 16.22 Safety Common Parameters

<b>(PR)</b>	<b>#51001</b>	<b>SIO_Enable</b>	<b>Enable safety related I/O observation</b>
Select whether to enable the safety related I/O observation.			
0: Disable			
1: Enable			
<b>(PR)</b>	<b>#51002</b>	<b>SLS_Enable</b>	<b>Enable SLS observation</b>
Select whether to enable the safely limited speed observation.			
0: Disable			
1: Enable			
<b>(PR)</b>	<b>#51003</b>	<b>SLP_Enable</b>	<b>Enable SLP observation</b>
Select whether to enable the safely limited position observation.			
0: Disable			
1: Enable			
<b>(PR)</b>	<b>#51004</b>	<b>SSM_Enable</b>	<b>Enable Safe speed monitor</b>
Select whether to enable the safe speed monitor.			
0: Disable			
1: Enable			
<b>(PR)</b>	<b>#51005</b>	<b>SCA_Enable</b>	<b>Enable safe cam</b>
Select whether to enable the safe cam.			
0: Disable			
1: Enable			
<b>(PR)</b>	<b>#51006</b>	<b>SOS_Enable</b>	<b>Enable Safe operating stop</b>
Select whether to enable the safe operating stop.			
0: Disable			
1: Enable			
(*) When SS2 is executed, SOS is activated irrespective of this parameter.			
<b>(PR)</b>	<b>#51007</b>	<b>SS1_Enable</b>	<b>Enable Safe stop 1</b>
Select whether to enable the safe stop 1.			
0: Disable			
1: Enable			
(*) Irrespective of this parameter, when a smart safety observation error is detected, SS1 may be activated depending on the setting of "#51102 SF_Stoptype".			
<b>(PR)</b>	<b>#51008</b>	<b>SS2_Enable</b>	<b>Enable Safe stop 2</b>
Select whether to enable the safe stop 2.			
0: Disable			
1: Enable			
<b>(PR)</b>	<b>#51009</b>	<b>STO_Enable</b>	<b>Enable Safe torque off</b>
Select whether to enable the safe torque off.			
0: Disable			
1: Enable			
(*) Irrespective of this parameter, when a smart safety observation error is detected, STO may be activated depending on the setting of "#51102 SF_Stoptype".			
<b>(PR)</b>	<b>#51010</b>	<b>SBC_Enable</b>	<b>Safe brake control enabled</b>
Select whether to enable the safe brake control.			
0: Disable			
1: Enable			

<b>(PR)</b>	<b>#51011</b>	<b>SBT_INT</b>	<b>SBT interval</b>
			Set the time that elapses before the next SBT incomplete signal (SBTNFEXm / SBTNFMOm) turns ON after completing the brake test. When set "0", the interval will be 8 hours. <b>---Setting range---</b> 0 to 255 hours
<b>(PR)</b>	<b>#51012</b>	<b>CRSCHK_TOL</b>	<b>Cross-check status inconsistency tolerable time</b>
			Set the tolerable time for inconsistency between CPUs status. (When the status is inconsistent for more than tolerable time, the alarm occurs and the motor power shuts OFF.) When set "0", the inconsistency tolerable time is 100 ms. <b>---Setting range---</b> 0 to 5000 (ms)
	<b>#51013</b>	<b>SF_PSWD</b>	<b>Safe password</b>
			Set the safety password. Setting: 7 or 8 uppercase alphanumeric characters If no password is set, turn ON the machine parameter setup mode to set the safety parameters. <b>---Setting range---</b> 7 or 8 uppercase alphanumeric characters
<b>(PR)</b>	<b>#51015</b>	<b>safe_drv_test</b>	<b>Drive safety function easy test mode</b>
			Select whether to enable the simple test mode in which the drive safety function operation can be checked without connecting any smart safety observation-capable drive unit. 0: Disable the drive safety function simple test mode 1: Enable the drive safety function simple test mode
<b>(PR)</b>	<b>#51016</b>	<b>SCN_Enable</b>	<b>Safety communication network valid</b>
			Select whether to enable or disable the safety communication network. 0: Disabled 1: Enabled
<b>(PR)</b>	<b>#51701</b>	<b>SCN_Slot No.</b>	<b>Safety communication network slot No.</b>
			Select the number of the slot in which the CC-Link IE Field network module managed by CNC CPU or the CC-Link IE TSN module accessible from CNC CPU is mounted. (* ) Set the I/O number of the base unit. When connecting the CC-Link IE Field network module, do not set a slot number that has already been set for any other CPU. <b>---Setting range---</b> 0 to 11
<b>(PR)</b>	<b>#51702</b>	<b>SCN_Network No.</b>	<b>Safety communication network No.</b>
			Specify the network number of the CNC-controlled CC-Link IE Field network module. (* ) Set the network number of the master station. <b>---Setting range---</b> 0 to 239
<b>(PR)</b>	<b>#51703</b>	<b>SCN_Station No.</b>	<b>Safety communication network station No.</b>
			Specify the station number of the CNC-controlled CC-Link IE Field network module. (* ) Set the unique station number of the master station. <b>---Setting range---</b> 0 to 120

(PR)	#51704	SCN_SIM Time	Safety communication network transmission interval to be monitored
			<p>In each safety connection, a safety communication error is detected by the CC-Link IE Field network module managed by CNC CPU or by the CC-Link IE TSN module accessible from CNC CPU. Specify the transmission interval to be monitored for the detection.</p> <p>Note that when the set value is in the range of 0 to 349, the default value "350" is applied (Transmission interval to be monitored is 35 ms).</p> <p>---Setting range---</p> <p>0 to 10000 (100 <math>\mu</math>s)</p>
(PR)	#51705	SCN_IETSN_MA IP	CC-Link IE TSN master station IP address
			<p>This parameter specifies the IP address of the master station to be connected to the CC-Link IE TSN safety communication.</p> <p>(*) Do not set the following address.</p> <ul style="list-style-type: none"> <li>♦The numbers in the 3rd and 4th octets contain all 0s or 1s.</li> <li>♦The host address contains all 0s or 1s.</li> <li>♦Reserved address</li> </ul> <p>---Setting range---</p> <p>0.0.0.0 to 255.255.255.255</p>
(PR)	#51706	SCN_IETSN_OWN IP	CC-Link IE TSN own station IP address
			<p>This parameter specifies the IP address of the own station to be connected to the CC-Link IE TSN safety communication.</p> <p>(*) Do not set the following address.</p> <ul style="list-style-type: none"> <li>♦The numbers in the 3rd and 4th octets contain all 0s or 1s.</li> <li>♦The host address contains all 0s or 1s.</li> <li>♦Reserved address</li> </ul> <p>---Setting range---</p> <p>0.0.0.0 to 255.255.255.255</p>

## 16.23 Safety Axis Parameters

(PR)	#51101	SF_Disable	Disable smart safety observation
<p>Exclude the axis from the smart safety observation target.</p> <p>0: Enable smart safety observation 1: Disable smart safety observation</p> <p>(Note) The settings of "#51101 SF_Disable" and "#51301 SF_SDisable" must be the same within a multi-hybrid drive unit.</p>			
(PR)	#51102	SF_Stoptype	Stop method at error
<p>Select which of the safe stop methods to use when an error is detected in the smart safety observation.</p> <p>0: STO 1: SS1</p>			
(PR)	#51103-51106	SLS_Speed1-4	SLS speed tolerance 1-4
<p>Specify the upper limits of machine-end speed determined as safe for each of SLS speed tolerances 1 to 4. If the SLS detection delay time has elapsed with the command/FB speed exceeding the safely-limited speed while SLS is ON, a safe stop (SS1 or STO) is executed. The safely-limited speed to be applied to SLS is calculated using the following equation.</p> <p>Safely-limited speed = SLS speed tolerance x SLS speed override / 100</p> <p>---Setting range---</p> <p>0 to 999999 (mm/min or °/min)</p>			
(PR)	#51107-51122	SLS_Override1-16	SLS speed override 1-16
<p>Specify the speed overrides 1 to 16 with respect to SLS speed tolerances 1 to 4. For details refer to SLS speed tolerances 1 to 4.</p> <p>---Setting range---</p> <p>0 to 100 (%)</p>			
(PR)	#51123	SLS_Clamp	SLS speed clamp ratio
<p>Specify the speed clamp ratio that is applied while SLS is ON. Set the ratio to about 80 to 90%. While SLS is ON, the command speed is clamped at the following speed:</p> <p>Clamp speed = Safely-limited speed x SLS speed clamp ratio / 100</p> <p>(Safely-limited speed = SLS speed tolerance x SLS speed override / 100)</p> <p>---Setting range---</p> <p>0 to 100 (%)</p>			
	#51124	SLS_T1	SLS detection delay time
<p>Specify a period of time to detect a speed error while SLS is ON. A safe stop (SS1 or STO) is executed if the period of time set in this parameter has elapsed with the command/FB speed exceeding the safely-limited speed.</p> <p>---Setting range---</p> <p>0 to 9999 (ms)</p>			
	#51125	SLS_T2	SLS deceleration observation time
<p>Specify a period of time to detect a deceleration error that is caused due to change of the safely-limited speed at the start of or during SLS. If you have changed the safely-limited speed at the start of or during SLS, and the time set in this parameter has elapsed with the command/FB speed exceeding the safely-limited speed, a safe stop (SS1 or STO) is executed. When set to "0", the detection time is treated as 200(ms).</p> <p>---Setting range---</p> <p>0 to 99999 (ms)</p>			

(PR)	#51126+2(n-1)	SLP_PositionPn	SLP position tolerance n (+)
	<p>"n" represents the SLP position tolerance No. (n=1 to 4)</p> <p>Specify the upper and lower limits of machine position, which is determined as safe, for each of SLP position tolerances 1(+) to 4(+). If the SLP detection delay time has elapsed while SLP is ON with the command/FB position outside the SLP position tolerance range, a safe stop (SS1 or STO) is executed.</p> <p>*SLP is not available for a rotation-type rotary axis.</p> <p>---Setting range---</p> <p>-99999.999 to +99999.999 (mm)</p>		
(PR)	#51127+2(n-1)	SLP_PositionMn	SLP position tolerance n (-)
	<p>"n" represents the SLP position tolerance No. (n=1 to 4)</p> <p>Specify the upper and lower limits of machine position, which is determined as safe, for each of SLP position tolerances 1(-) to 4(-). If the SLP detection delay time has elapsed while SLP is ON with the command/FB position outside the SLP position tolerance range, a safe stop (SS1 or STO) is executed.</p> <p>*SLP is not available for a rotation-type rotary axis.</p> <p>---Setting range---</p> <p>-99999.999 to +99999.999 (mm)</p>		
	#51134	SLP_T1	SLP detection delay time
	<p>Specify a period of time to detect a machine position error while SLP is ON. If the time set in this parameter has elapsed with the command/FB position outside the SLP position tolerance range, a safe stop (SS1 or STO) is executed.</p> <p>---Setting range---</p> <p>0 to 9999 (ms)</p>		
(PR)	#51135- 51138	SSM_Speed1-4	SSM speed 1-4
	<p>Specify the upper limits of machine-end speed determined as safe for each of SSM speeds 1 to 4. If the command/FB speed is at the safe speed or lower while SSM is ON, the Under SSM safe speed signal turns ON. If the command/FB speed exceeds the safe speed, the Under SSM safe speed signal turns OFF. The safe speed to be applied to SSM is calculated using the following equation.</p> <p>(When the Under SSM safe speed signal is ON) Safe speed = SSM speed</p> <p>(When the Under SSM safe speed signal is OFF) Safe speed = SSM speed - SSM hysteresis width</p> <p>---Setting range---</p> <p>0 to 999999 (mm/min or °/min)</p>		
	#51139- 51142	SSM_Hysteresis1-4	SSM hysteresis width 1-4
	<p>Specify the hysteresis widths that correspond to SSM speeds 1 to 4. For details refer to SSM speeds 1 to 4.</p> <p>---Setting range---</p> <p>0 to 999999 (mm/min or °/min)</p>		
(PR)	#51143+2(n-1)	SCA_PositionPn	SCA position n (+)
	<p>"n" represents the SCA position No. (n=1 to 16)</p> <p>Specify the upper and lower limits of machine position determined as safe for each of SCA positions 1(+) to 16(+). If the command/FB position is in the SCA safe position or smaller while SCA is ON, the Safe cam position signal turns OFF. If the position has exceeded the SCA safe position, the Safe cam position signal turns ON. The SCA safe position is calculated using the following equation.</p> <p>(When the Safe cam position signal is ON) SCA safe position = SCA position (+) – SCA hysteresis width</p> <p>(When the Safe cam position signal is OFF) SCA safe position = SCA position (+)</p> <p>---Setting range---</p> <p>-99999.999 to +99999.999 (mm)</p>		

<b>(PR)</b>	<b>#51144+2(n-1)</b>	<b>SCA_PositionMn</b>	<b>SCA position n (-)</b>
		<p>"n" represents the SCA position No. (n=1 to 16)</p> <p>Specify the upper and lower limits of machine position determined as safe for each of SCA positions 1(-) to 16(-). If the command/FB position is in the SCA safe position or smaller while SCA is ON, the Safe cam position signal turns OFF. If the position has exceeded the SCA safe position, the Safe cam position signal turns ON. The SCA safe position is calculated using the following equation.</p> <p>(When the Safe cam position signal is ON)  SCA safe position = SCA position (-) – SCA hysteresis width</p> <p>(When the Safe cam position signal is OFF)  SCA safe position = SCA position (-)</p> <p><b>---Setting range---</b></p> <p>-99999.999 to +99999.999 (mm)</p>	
	<b>#51175</b>	<b>SCA_Hysteresis</b>	<b>SCA hysteresis width</b>
		<p>Specify the hysteresis widths that correspond to SCA positions 1 to 16. For details refer to SCA positions 1(+/-) to 16(+/-).</p> <p><b>---Setting range---</b></p> <p>0 to 99999.999 (mm)</p>	
<b>(PR)</b>	<b>#51176</b>	<b>SOS_Speed</b>	<b>SOS stop speed</b>
		<p>Specify the upper limit of machine-end speed determined as a safe operating stop.</p> <ul style="list-style-type: none"> <li>•If the SOS_V detection delay time has elapsed with the command/FB speed exceeding the speed of this parameter while SOS is ON, a safe stop (SS1 or STO) is executed.</li> <li>•The point of time at which the command/FB speed drops to that of this parameter or lower while SS1/SS2 is ON is treated as a standstill.</li> </ul> <p>*When this parameter is set to 0, "SOS speed error" may occur even though the axis is at a standstill.</p> <p><b>---Setting range---</b></p> <p>0 to 9999 (mm/min or °/min)</p>	
	<b>#51177</b>	<b>SOS_T1</b>	<b>SOS_V detection delay time</b>
		<p>Specify a period of time to detect a speed error while SOS is ON. If the period of time set in this parameter has elapsed with the command/FB speed exceeding the SOS stop speed while SOS is ON, a safe stop (SS1 or STO) is executed.</p> <p><b>---Setting range---</b></p> <p>0 to 9999 (ms)</p>	
<b>(PR)</b>	<b>#51178</b>	<b>SOS_Droop</b>	<b>SOS position deviation tolerance</b>
		<p>Specify the upper limit of machine-end position deviation determined as a safe operating stop. If the SOS_PD detection delay time has elapsed with the position deviation (difference between the command and FB positions) exceeding that of this parameter while SOS is ON, a safe stop (SS1 or STO) is executed.</p> <p>*When this parameter is set to 0, "SOS position deviation error" may occur even though the axis is at a standstill.</p> <p><b>---Setting range---</b></p> <p>0 to 9999.999 (mm or °)</p>	
	<b>#51179</b>	<b>SOS_T2</b>	<b>SOS_PD detection delay time</b>
		<p>Specify a period of time to detect a position deviation error while SOS is ON. If a period of time set in this parameter has elapsed with the position deviation (difference between the command and FB positions) exceeding the SOS position deviation tolerance while SOS is ON, a safe stop (SS1 or STO) is executed.</p> <p><b>---Setting range---</b></p> <p>0 to 9999 (ms)</p>	
<b>(PR)</b>	<b>#51180</b>	<b>SOS_PositionM</b>	<b>SOS travel distance tolerance (-)</b>
		<p>Specify the upper limit of machine-end travel distance (minus side) determined as a safe operating stop. If the SOS_P detection delay time has elapsed with the command/FB travel distance in the minus direction exceeding that of this parameter while SOS is ON, a safe stop (SS1 or STO) is executed.</p> <p>*When this parameter is set to 0, "SOS travel distance error" may occur even though the axis is at a standstill.</p> <p><b>---Setting range---</b></p> <p>0 to 9999.999 (mm or °)</p>	



(PR)	#51181	SOS_PositionP	SOS travel distance tolerance (+)
			Specify the upper limit of machine-end travel distance (plus side) determined as a safe operating stop. If the SOS_P detection delay time has elapsed with the command/FB travel distance in the plus direction exceeding that of this parameter while SOS is ON, a safe stop (SS1 or STO) is executed. *When this parameter is set to 0, "SOS travel distance error" may occur even though the axis is at a standstill.
			---Setting range--- 0 to 9999.999 (mm or °)
	#51182	SOS_T3	SOS_P detection delay time
			Specify a period of time to detect a travel distance error while SOS is ON. If the period of time set in this parameter has elapsed with the command/FB travel distance exceeding the SOS travel distance tolerance (+/-) while SOS is ON, a safe stop (SS1 or STO) is executed.
			---Setting range--- 0 to 9999 (ms)
	#51183	SS1_T1	SS1 deceleration observation time
			Specify a period of time to detect a deceleration error while SS1 is ON. If the time set in this parameter has elapsed with the command/FB speed exceeding the SOS stop speed, STO is activated.
			---Setting range--- 0 to 99999 (ms)
	#51184	SS2_T1	SS2 deceleration observation time
			Specify a period of time to detect a deceleration error while SS2 is ON. If the time set in this parameter has elapsed with the command/FB speed exceeding the SOS stop speed, STO is activated.
			---Setting range--- 0 to 99999 (ms)
(PR)	#51185	STO_EXEWT	Waiting time before STO execution
			Specify a period of time to wait from when the drive unit receives an STO request from the NC until when STO is actually executed. Set this time so that the brake is activated within this period of time. When set to "0", the STO execution standby time is treated as 200 ms.
			---Setting range--- 0 to 20000 (ms)
(PR)	#51186	SBTEX_Enable	External brake SBT enabled
			0: Disable 1: Enable
(PR)	#51187	SBTMO_Enable	Motor brake SBT enabled
			0: Disable 1: Enable
	#51191	SBT_ILIM	SBT current limit value
			Set the current limit value in the brake test in proportion to the stall current. When set to "0", the alarm occurs at the start of the brake test. (The test does not start.)
			---Setting range--- 0 to 100 (%)
(PR)	#51192	SBT_CMDWT	SBT command wait time
			Set the wait time of output of movement command for brake test from NC since receiving SBT starting signal (SBTSTEXm / SBTSTMOM). When set to "0", the commanded wait time is 400 ms.
			---Setting range--- 0 to 30000 (ms)
(PR)	#51193	SBT_FD	SBT command movement amount
			Set the movement amount to command to the test target axis at the time of brake test. When set to "0", the alarm occurs at the start of the brake test. (The test does not start.)
			---Setting range--- -99999.999 to 99999.999 (mm or °)

<b>(PR)</b>	<b>#51194</b>	<b>SBT_FDRATE</b>	<b>SBT command speed</b>
Set the command speed to command to the test target axis at the time of brake test. When set to "0", the alarm occurs at the start of the brake test. (The test does not start.)			
<b>---Setting range---</b>			
0 to 1000000 (mm/min or °/min)			
<b>(PR)</b>	<b>#51195</b>	<b>SBT_OBTIM</b>	<b>SBT observation time</b>
Set the time to continue the observation of axis movement amount after the output of movement command for test at the time of brake test. When set to "0", the observation time is 1000 ms.			
<b>---Setting range---</b>			
0 to 30000 (ms)			
<b>(PR)</b>	<b>#51196</b>	<b>SBT_TOL</b>	<b>SBT tolerable movement amount</b>
Set the tolerable movement amount of the test target axis at the time of brake test. (The alarm occurs if the movement amount during the test exceeds this parameter value.) When set "0", the tolerable movement amount is 100 mm (or °).			
<b>---Setting range---</b>			
0 to 99999.999 (mm or °)			
<b>(PR)</b>	<b>#51197</b>	<b>SLP/SCA_FDTOL</b>	<b>SLP/SCA tolerable movement amount during power OFF</b>
Sets the tolerable value of the difference (error amount) between [saved position at power shut OFF] and [restored position at power ON] in SLP/SCA encoder diagnosis during power OFF. When this above difference exceeds the tolerable value, the system starts in STO status. When set "0", the tolerable value is as in below formula.			
Tolerable movement amount = SV018(PIT) * 0.9			
<b>---Setting range---</b>			
0 to 99999.999 (mm)			
<b>(PR)</b>	<b>#51198</b>	<b>MIRtAbsSEnc_FDChk</b>	<b>SLP/SCA encoder diagnosis during power OFF application for Multi revolution safety encoder</b>
Enables the encoder diagnosis during power OFF to use SLP/SCA for the axes connected with Multi revolution safety encoder.			
0: Disable the encoder diagnosis during power OFF to use SLP/SCA for the axes connected with Multi revolution safety encoder			
1: Enable the encoder diagnosis during power OFF to use SLP/SCA for the axes connected with Multi revolution safety encoder			
* As for the axes not connected with Multi revolution safety encoder, the above diagnosis will be enabled regardless of the setting value of this parameter.			
* The above diagnosis will not be executed when SLP/SCA are disabled. (Both SLP_Enable and SCA_Enable are 0.)			
	<b>#51199</b>	<b>SF_PDCHK_TOL</b>	<b>Servo axis position deviation diagnosis tolerable value</b>
Sets the tolerable value of the position deviation (the difference between the commanded position generated inside NC and the feedback position received from drive unit) in the position deviation diagnosis. When the position deviation exceeds the tolerable value, the Safe stop (SS1/STO) will be carried out. When "0" is set, the tolerable value is as in below formula.			
Tolerable value = SV018(PIT) * 2.0			
<b>---Setting range---</b>			
0 to 32767 (mm or °)			

(PR)	#51200	SFSPEC1	Safety specification 1
			<p>Specify the Safety axis's specification by turning ON the corresponding bit. Input the hexadecimal value for this parameter.</p> <p>bit0-2: Not used</p> <p>bit3: Motor brake connection status</p> <p>0: Motor brake connected</p> <p>1: Motor brake not connected</p> <p>bit4-F: Not used</p> <p>* If the settings of encoder type (bit0, bit1) are different from the actually connected ones, the servo alarm 4D is output.</p> <p><b>---Setting range---</b></p> <p>0x0000 to 0xFFFF</p>
(PR)	#51201	SENCTYP	Safety encoder type
			<p>For a safety encoder-connected axis, set the safety encoder type. When the Multi revolution part is connected to the safety encoder that is outside the certification of safety standards, and in SLP/SCA enabled, SLP/SCA encoder diagnosis during power OFF will be carried out regardless of the setting value of #51198 MI-RtAbsSEnc_FDChk.</p> <p>0: Safety encoder that is outside the safety certification for Multi revolution</p> <p>1: Safety encoder that is certified with safety standards for Multi revolution</p>

## 16.24 Safety Spindle Parameters

(PR)	#51301	SF_SDisable	Disable smart safety observation
<p>Exclude the axis from the smart safety observation target.</p> <p>0: Enable smart safety observation 1: Disable smart safety observation</p> <p>(Note) The settings of "#51101 SF_Disable" and "#51301 SF_SDisable" must be the same within a multi-hybrid drive unit.</p>			
(PR)	#51302	SF_SStoptype	Stop method at error
<p>Select which of the safe stop methods to use when an error is detected in the smart safety observation.</p> <p>0: STO 1: SS1</p>			
(PR)	#51303- 51306	SLS_SSspeed1-4	SLS speed tolerance 1-4
<p>Specify the upper limits of machine-end speed determined as safe for each of SLS speed tolerances 1 to 4. If the SLS detection delay time has elapsed with the command/FB speed exceeding the safely-limited speed while SLS is ON, a safe stop (SS1 or STO) is executed. The safely-limited speed to be applied to SLS is calculated using the following equation.</p> <p>Safely-limited speed = SLS speed tolerance x SLS speed override / 100</p> <p>---Setting range---</p> <p>0 to 999999.9 (r/min)</p>			
(PR)	#51307- 51322	SLS_SOverride1-16	SLS speed override 1-16
<p>Specify the speed overrides 1 to 16 with respect to SLS speed tolerances 1 to 4. For details refer to SLS speed tolerances 1 to 4.</p> <p>---Setting range---</p> <p>0 to 100 (%)</p>			
(PR)	#51323	SLS_Sclamp	SLS speed clamp ratio
<p>Specify the speed clamp ratio that is applied while SLS is ON. Set the ratio to about 80 to 90%. While SLS is ON, the command speed is clamped at the following speed:</p> <p>Clamp speed = Safely-limited speed x SLS speed clamp ratio / 100</p> <p>(Safely-limited speed = SLS speed tolerance x SLS speed override / 100)</p> <p>---Setting range---</p> <p>0 to 100 (%)</p>			
	#51324	SLS_ST1	SLS detection delay time
<p>Specify a period of time to detect a speed error while SLS is ON. A safe stop (SS1 or STO) is executed if the period of time set in this parameter has elapsed with the command/FB speed exceeding the safely-limited speed.</p> <p>---Setting range---</p> <p>0 to 9999 (ms)</p>			
	#51325	SLS_ST2	SLS deceleration observation time
<p>Specify a period of time to detect a deceleration error that is caused due to change of the safely-limited speed at the start of or during SLS. If you have changed the safely-limited speed at the start of or during SLS, and the time set in this parameter has elapsed with the command/FB speed exceeding the safely-limited speed, a safe stop (SS1 or STO) is executed. When set to "0", the detection time is treated as 200(ms).</p> <p>---Setting range---</p> <p>0 to 99999 (ms)</p>			

(PR)	#51326- 51329	SSM_SSspeed1-4	SSM speed 1-4
		<p>Specify the upper limits of machine-end speed determined as safe for each of SSM speeds 1 to 4. If the command/FB speed is at the safe speed or lower while SSM is ON, the Under SSM safe speed signal turns ON. If the command/FB speed exceeds the safe speed, the Under SSM safe speed signal turns OFF. The safe speed to be applied to SSM is calculated using the following equation.</p> <p>(When the Under SSM safe speed signal is ON) Safe speed = SSM speed</p> <p>(When the Under SSM safe speed signal is OFF) Safe speed = SSM speed - SSM hysteresis width</p> <p>---Setting range---</p> <p>0 to 999999.9 (r/min)</p>	
	#51330- 51333	SSM_SHysteresis1-4	SSM hysteresis width 1-4
		<p>Specify the hysteresis widths that correspond to SSM speeds 1 to 4. For details refer to SSM speeds 1 to 4.</p> <p>---Setting range---</p> <p>0 to 999999.9 (r/min)</p>	
(PR)	#51334	SOS_SSspeed	SOS stop speed
		<p>Specify the upper limit of machine-end speed determined as a safe operating stop.</p> <ul style="list-style-type: none"> <li>•If the SOS_V detection delay time has elapsed with the command/FB speed exceeding that of this parameter while SOS is ON, a safe stop (SS1 or STO) is executed.</li> <li>•The point of time at which the command/FB speed drops to that of this parameter or lower while SS1/SS2 is ON is treated as a standstill.</li> </ul> <p>*When this parameter is set to 0, "SOS speed error" may occur even though the spindle is at a standstill.</p> <p>---Setting range---</p> <p>0 to 9999.9 (r/min)</p>	
	#51335	SOS_ST1	SOS_V detection delay time
		<p>Specify a period of time to detect a speed error while SOS is ON. If the period of time set in this parameter has elapsed with the command/FB speed exceeding the SOS stop speed while SOS is ON, a safe stop (SS1 or STO) is executed.</p> <p>---Setting range---</p> <p>0 to 9999 (ms)</p>	
(PR)	#51336	SOS_SDroop	SOS position deviation tolerance
		<p>Specify the upper limit of machine-end position deviation determined as a safe operating stop. If the SOS_PD detection delay time has elapsed with the position deviation (difference between the command and FB positions) exceeding that of this parameter while SOS is ON, a safe stop (SS1 or STO) is executed.</p> <p>*When this parameter is set to 0, "SOS position deviation error" may occur even though the spindle is at a standstill.</p> <p>---Setting range---</p> <p>0 to 9999 (°)</p>	
	#51337	SOS_ST2	SOS_PD detection delay time
		<p>Specify a period of time to detect a position deviation error while SOS is ON. If a period of time set in this parameter has elapsed with the position deviation (difference between the command and FB positions) exceeding the SOS position deviation tolerance while SOS is ON, a safe stop (SS1 or STO) is executed.</p> <p>---Setting range---</p> <p>0 to 9999 (ms)</p>	
(PR)	#51338	SOS_SPositionM	SOS travel distance tolerance (-)
		<p>Specify the upper limit of machine-end travel distance (minus side) determined as a safe operating stop. If the SOS_P detection delay time has elapsed with the command/FB travel distance in the minus direction exceeding that of this parameter while SOS is ON, a safe stop (SS1 or STO) is executed.</p> <p>*When this parameter is set to 0, "SOS travel distance error" may occur even though the spindle is at a standstill.</p> <p>---Setting range---</p> <p>0 to 9999 (°)</p>	

(PR)	#51339	SOS_SPositionP	SOS travel distance tolerance (+)
		Specify the upper limit of machine-end travel distance (plus side) determined as a safe operating stop. If the SOS_P detection delay time has elapsed with the command/FB travel distance in the plus direction exceeding that of this parameter while SOS is ON, a safe stop (SS1 or STO) is executed.	
		*When this parameter is set to 0, "SOS travel distance error" may occur even though the spindle is at a standstill.	
		---Setting range---	
		0 to 9999 (°)	
	#51340	SOS_ST3	SOS_P detection delay time
		Specify a period of time to detect a travel distance error while SOS is ON. If the period of time set in this parameter has elapsed with the command/FB travel distance exceeding the SOS travel distance tolerance (+/-) while SOS is ON, a safe stop (SS1 or STO) is executed.	
		---Setting range---	
		0 to 9999 (ms)	
	#51341	SS1_ST1	SS1 deceleration observation time
		Specify a period of time to detect a deceleration error while SS1 is ON. If the time set in this parameter has elapsed with the command/FB speed exceeding the SOS stop speed, STO is activated.	
		---Setting range---	
		0 to 99999 (ms)	
	#51342	SS2_ST1	SS2 deceleration observation time
		Specify a period of time to detect a deceleration error while SS2 is ON. If the time set in this parameter has elapsed with the command/FB speed exceeding the SOS stop speed, STO is activated.	
		---Setting range---	
		0 to 99999 (ms)	
(PR)	#51343	STO_SEXEW	Waiting time before STO execution
		Specify a period of time to wait from when the drive unit receives an STO request from the NC until when STO is actually executed. Set this time so that the brake is activated within this period of time. When set to "0", the STO execution standby time is treated as 200 ms.	
		---Setting range---	
		0 to 20000 (ms)	
	#51344	SF_PDCHK_ST1	Spindle position deviation diagnosis waiting time
		Set the waiting time for starting the position deviation diagnosis at Spindle non-interpolation mode. The diagnosis of the position deviation at Spindle non-interpolation mode starts after the commanded speed becomes consistent and after the time set by this parameter passes. It stops while the command speed is changing. When set to "0", the Spindle position deviation diagnosis waiting time is 20000 ms.	
		---Setting range---	
		0 to 30000 (ms)	
	#51345	SF_PDCHK_STOL	Spindle position deviation diagnosis tolerable value
		Sets the tolerable value of the position deviation (the difference between the commanded position generated inside NC and the feedback position received from drive unit) in the position deviation diagnosis. When the position deviation exceeds the tolerable value, the Safe stop (SS1/STO) will be carried out. When set to "0", the tolerable value is 1080°.	
		---Setting range---	
		0 to 32767 (°)	

## 16.25 Safety I/O Assignment Parameters

(PR)	#51501+10(n-1)	RIO CH No. #n	Target channel number #n
		Specify the channel No. to which the nth safety I/O unit is connected. (n=1 to 3)	
		* When set to "0", the RIO assignment parameters of the nth station are all disabled.	
		---Setting range---	
		0, 1	
(PR)	#51502+10(n-1)	RIO Station No. #n	Target station number #n
		Specify the station No. of the nth safety I/O unit. (n=1 to 3)	
		* Set this parameter to the same value as of the rotary switch on the safety I/O unit to which the device is assigned.	
		---Setting range---	
		0 to 3	
(PR)	#51503+10(n-1)	DI dev name #n	DI device name #n
		Specify the name of the DI assignment devices of the nth safety I/O unit. (n=1 to 3)	
		* When set to "0", the name is left blank.	
		---Setting range---	
		0, X	
(PR)	#51504+10(n-1)	DI dev No. #n	DI device number #n
		Specify the head device No. of DI assignment devices of the nth safety I/O unit. (n=1 to 3)	
		* This parameter changes to "0" if you change the device name "DI dev name #n".	
		* Specify "DI dev name #n" ahead of this parameter.	
		---Setting range---	
		X: 0 to 1FF (hexadecimal)	
(PR)	#51505+10(n-1)	DO dev name #n	DO device name #n
		Specify the name of the DO assignment devices of the nth safety I/O unit. (n=1 to 3)	
		* When set to "0", the name is left blank.	
		---Setting range---	
		0, Y	
(PR)	#51506+10(n-1)	DO dev No. #n	DO device number #n
		Specify the head device No. of the DO assignment devices of the nth safety I/O unit. (n=1 to 3)	
		* The setting of this parameter changes to "0" if you change the device name of "DO dev name #n".	
		* Specify "DO dev name #n" ahead of this parameter.	
		* Set the same value as DI device No.	
		---Setting range---	
		Y: 0 to 1FF (hexadecimal)	
(PR)	#51582	EMG_Dev1_ch	Emergency stop signal 1 channel No.
		Specify the No. of I/O channel to connect the safety I/O unit that receives the emergency stop signal. When specifying the channel No. and station No. of the emergency stop signal, set any of the safety I/O units specified by the parameters RIO CH No. and RIO Station No. When set to "0", the designation of emergency stop signal device by EMG_Dev1 is disabled, irrespective of the settings of EMG_Dev1_stn and EMG_Dev1_bit.	
		---Setting range---	
		0, 1	
(PR)	#51583	EMG_Dev1_stn	Emergency stop signal 1 station No.
		Specify the No. of station to connect the safety I/O unit that receives the emergency stop signal.	
		---Setting range---	
		0 to 3	

<b>(PR)</b>	<b>#51584</b>	<b>EMG_Dev1_bit</b>	<b>Emergency stop signal 1 bit No.</b>
			Specify the bit No. of the safety I/O unit that receives the emergency stop signal.
			<b>---Setting range---</b>
			1 to 31
<b>(PR)</b>	<b>#51585</b>	<b>EMG_Dev2_ch</b>	<b>Emergency stop signal 2 channel No.</b>
			Specify the No. of I/O channel to connect the safety I/O unit that receives the emergency stop signal. When specifying the channel No. and station No. of the emergency stop signal, set any of the safety I/O units specified by the parameters RIO CH No. and RIO Station No. When set to "0", the designation of emergency stop signal device by EMG_Dev2 is disabled, irrespective of the settings of EMG_Dev2_stn and EMG_Dev2_bit.
			<b>---Setting range---</b>
			0, 1
<b>(PR)</b>	<b>#51586</b>	<b>EMG_Dev2_stn</b>	<b>Emergency stop signal 2 station No.</b>
			Specify the No. of station to connect the safety I/O unit that receives the emergency stop signal.
			<b>---Setting range---</b>
			0 to 3
<b>(PR)</b>	<b>#51587</b>	<b>EMG_Dev2_bit</b>	<b>Emergency stop signal 2 bit No.</b>
			Specify the bit No. of the safety I/O unit that receives the emergency stop signal.
			<b>---Setting range---</b>
			0 to 31
<b>(PR)</b>	<b>#51591</b>	<b>SIO_DIDelay</b>	<b>Allowed input signal compare time</b>
			Specify the allowed time of inconsistency between the PLC1 and PLC2 side input signals. Specify this in increments of 10 (ms). When set to "0", the allowed safety signal compare time is 300 (ms).
			<b>---Setting range---</b>
			0 to 500 (10 ms)
<b>(PR)</b>	<b>#51592</b>	<b>SIO_DODelay</b>	<b>Allowed output signal compare time</b>
			Specify the allowed time of inconsistency between the PLC1 and PLC2 side output signals. Specify this in increments of 10 (ms). When set to "0", the allowed safety signal compare time is 300 (ms).
			<b>---Setting range---</b>
			0 to 50 (10 ms)
<b>(PR)</b>	<b>#51593</b>	<b>SIO_DOErrtype</b>	<b>DO control method at diagnostic error</b>
			Select the DO control method and PLC status of when a safety signal observation error occurs.
			0: PLC is set in RUN state and DO is controlled through user safety sequence
			1: PLC is set in STOP state and all DOs are OFF.
<b>(PR)</b>	<b>#51594</b>	<b>SIO_DODelay2</b>	<b>Allowed output signal compare time 2</b>
			Specify the allowed time of inconsistency between the PLC1 and PLC2 side output signals. Specify this in increments of 10 (ms). When set to "0", the allowed safety signal compare time is 300 (ms).
			Set tolerable time more than 300 (ms), when an output signal is controlled with 100 (ms) timer.
			<b>---Setting range---</b>
			0 to 500 (10 ms)
<b>(PR)</b>	<b>#51595</b>	<b>SIO_StartCond</b>	<b>Safety related I/O observation start condition</b>
			Specify the start condition of safety related I/O observation.
			0: The observation is automatically started when the power is turned ON.
			1: The observation is started at the rising edge of safety related I/O observation start request signal. (ZR416/bit1)
			(Note) Set to "1" only when the power cannot be supplied to the safety I/O device when the controller power is turned ON.



## 16.26 Multi CPU Parameters

(PR)	#26801- 26832	EndRefDev1-32	END refresh device 1-32
			<p>Specify the head device No. of devices that are refreshed at the END process of ladder.</p> <p>For the range not refreshed by host CPU due to another CPU's setting (reception), the setting can be omitted.</p> <p>Device "RC" can be set when "#26751 DevCondecseRef" is set to "1".</p> <p><b>---Setting range---</b></p> <p>Device: X, Y, M, L, B, D, W, R, ZR, RC</p> <p>Device number: 0 to 99999</p>

## Revision History

Date of revision	Manual No.	Revision details
Apr. 2019	IB(NA)1501560-A	<p>First edition created.</p> <p>The contents of "M800/M80/E80/C80 Series Alarm/Parameter Manual" (IB-1501279-J) were divided to create the respective manuals, "M800/M80/E80 Series" and "C80 Series".</p> <p>The descriptions of this manual are based on S/W version B0 of Mitsubishi Electric CNC C80 Series.</p>
Jan. 2020	IB(NA)1501560-B	<p>The descriptions were revised corresponding to S/W version B5 of Mitsubishi Electric CNC C80 series.</p> <p>The following chapters were revised.</p> <ul style="list-style-type: none"> <li>- 1 Operation Errors (M)</li> <li>- 2 Stop Codes (T)</li> <li>- 4 MCP Alarms (Y)</li> <li>- 5 System Alarms (Z)</li> <li>- 6 Absolute Position Detection System Alarms (Z7*)</li> <li>- 8 Emergency Stop Alarms (EMG)</li> <li>- 13 Smart Safety Observation Alarm (V)</li> <li>- 14 Multi CPU Errors (A)</li> <li>- 15 User Parameters</li> <li>- 16 Machine Parameters</li> </ul> <p>Other mistakes were corrected.</p>
Aug. 2020	IB(NA)1501560-C	<p>The descriptions were revised corresponding to S/W version B7 of Mitsubishi Electric CNC C80 series.</p> <p>The following chapters were revised.</p> <ul style="list-style-type: none"> <li>- 1 Operation Errors (M)</li> <li>- 2 Stop Codes (T)</li> <li>- 3 Servo/Spindle Alarms (S)</li> <li>- 4 MCP Alarms (Y)</li> <li>- 10 User PLC Alarms (U)</li> <li>- 12 Program Errors (P)</li> <li>- 14 Multi CPU Errors (A)</li> <li>- 15 User Parameters</li> <li>- 16 Machine Parameters</li> </ul> <p>Other mistakes were corrected.</p>
Mar. 2022	IB(NA)1501560-D	<p>The descriptions were revised corresponding to S/W version BA of Mitsubishi Electric CNC C80 series.</p> <p>The following chapters were revised.</p> <ul style="list-style-type: none"> <li>- 1 Operation Errors (M)</li> <li>- 3 Servo/Spindle Alarms (S)</li> <li>- 4 MCP Alarms (Y)</li> <li>- 6 Absolute Position Detection System Alarms (Z7*)</li> <li>- 7 Distance-coded Reference Scale Errors (Z8*)</li> <li>- 10 User PLC Alarms (U)</li> <li>- 12 Program Errors (P)</li> <li>- 13 Smart Safety Observation Alarm (V)</li> <li>- 15 User Parameters</li> <li>- 16 Machine Parameters</li> </ul> <p>Other mistakes were corrected.</p>

# Global Service Network

## AMERICA

### **MITSUBISHI ELECTRIC AUTOMATION INC. (AMERICA FA CENTER)**

#### **Central Region Service Center (Chicago)**

500 CORPORATE WOODS PARKWAY, VERNON HILLS, ILLINOIS 60061, U.S.A.  
TEL: +1-847-478-2500 / FAX: +1-847-478-2650

**Minneapolis, MN Service Satellite**  
**Detroit, MI Service Satellite**  
**Grand Rapids, MI Service Satellite**  
**Milwaukee, WI Service Satellite**  
**Cleveland, OH Service Satellite**  
**Indianapolis, IN Service Satellite**  
**St. Louis, MO Service Satellite**

#### **South/East Region Service Center (Georgia)**

1845 SATELLITE BOULEVARD STE. 450, DULUTH, GEORGIA 30097, U.S.A.  
TEL: +1-678-258-4529 / FAX: +1-678-258-4519

**Charleston, SC Service Satellite**  
**Charlotte, NC Service Satellite**  
**Raleigh, NC Service Satellite**  
**Dallas, TX Service Satellite**  
**Houston, TX Service Satellite**  
**Hartford, CT Service Satellite**  
**Knoxville, TN Service Satellite**  
**Nashville, TN Service Satellite**  
**Baltimore, MD Service Satellite**  
**Pittsburg, PA Service Satellite**  
**Tampa, FL Service Satellite**  
**Syracuse, NY Service Satellite**  
**Orlando, FL Service Satellite**  
**Lafayette, LA Service Satellite**  
**Philadelphia, PA Service Satellite**

#### **Western Region Service Center (California)**

5900-B KATELLA AVE. - 5900-A KATELLA AVE, CYPRESS, CALIFORNIA 90630, U.S.A.  
TEL: +1-714-699-2625 / FAX: +1-847-478-2650

**San Jose, CA Service Satellite**  
**Seattle, WA Service Satellite**  
**Denver, CO Service Satellite**

#### **Canada Region Service Center (Toronto)**

4299 14TH AVENUE MARKHAM, ONTARIO L3R 0J2, CANADA  
TEL: +1-905-475-7728 / FAX: +1-905-475-7935

**Edmonton, AB Service Satellite**  
**Montreal, QC Service Satellite**

#### **Mexico Region Service Center (Queretaro)**

Parque Tecnológico Innovación Querétaro, Lateral Carretera Estatal 431, Km 2+200, Lote 91 Modulos 1 y 2  
Hacienda la Machorra, CP 76246, El Marqués, Querétaro, México  
TEL: +52-442-153 6050

**Monterrey, NL Service Satellite**  
**Mexico City, DF Service Satellite**

## BRAZIL

### **MITSUBISHI ELECTRIC DO BRASIL COMÉRCIO E SERVIÇOS LTDA.**

#### **Votorantim Office**

AV. GISELE CONSTANTINO,1578, PARQUE BELA VISTA, VOTORANTIM-SP, BRAZIL CEP:18.110-650  
TEL: +55-15-3023-9000

**Blumenau, Santa Catarina Office**

## EUROPE

### **MITSUBISHI ELECTRIC EUROPE B.V.**

#### **European Service Headquarters (Dusseldorf, GERMANY)**

Mitsubishi-Electric-Platz 1 40882 RATINGEN, GERMANY  
TEL: +49-2102-486-5000 / FAX: +49-2102-486-5910

#### **South Germany Service Center (Stuttgart)**

SCHELMENWASENSTRASSE 16-20, 70567 STUTTGART, GERMANY  
TEL: + 49-711-770598-123 / FAX: +49-711-770598-141

#### **France Service Center (Paris)**

2 RUE DE L'UNION, 92565 RUEIL-MALMAISON CEDEX, FRANCE  
TEL: +33-1-41-02-83-13 / FAX: +33-1-49-01-07-25

#### **France Service Satellite (Lyon)**

120, ALLEE JACQUES MONOD 69800 SAINT PRIEST FRANCE  
TEL: +33-1-41-02-83-13 / FAX: +33-1-49-01-07-25

#### **Italy Service Center (Milan)**

CENTRO DIR. COLLEONI, PALAZZO SIRIO, VIALE COLLEONI 7, 20864 AGRATE BRIANZA (MB) ITALY  
TEL: +39-039-6053-342 / FAX: +39-039-6053-206

#### **Italy Service Satellite (Padova)**

VIA G. SAVELLI, 24 - 35129 PADOVA, ITALY  
TEL: +39-039-6053-342 / FAX: +39-039-6053-206

#### **U.K. Service Center**

TRAVELLERS LANE, HATFIELD, HERTFORDSHIRE, AL10 8XB, U.K.  
TEL: +44-1707-288-780 / FAX: +44-1707-278 695

#### **Spain Service Center**

CTRA. RUBI, 76-80 8174 SAINT CUGAT DEL VALLES, BARCELONA, SPAIN  
TEL: +34-935-65-2236 / FAX: +34-935-89-1579

#### **Poland Service Center**

UL.KRAKOWSKA 50, 32-083 BALICE, POLAND  
TEL: +48-12-347-6500 / FAX: +48-12-630-4701

#### **Hungary Service Center**

BUDAÖRS OFFICE PARK, SZABADSÁG ÚT 117., 2040 BUDAÖRS, HUNGARY  
TEL: +48-12-347-6500 / FAX: +48-12-630-4701

#### **Turkey Service Center**

#### **MITSUBISHI ELECTRIC TURKEY ELEKTRİK ÜRÜNLERİ A.Ş**

SERIFALI MAHALLESİ KALE SOKAK. NO.41 34775  
UMRANIYE, ISTANBUL, TURKEY  
TEL: +90-216-969-2500 / FAX: +90-216-661-44-47

#### **Czech Republic Service Center**

#### **AutoCont Control Systems s.r.o (Service Partner)**

KAFKOVA 1853/3, 702 00 OSTRAVA 2, CZECH REPUBLIC  
TEL: +420-59-5691-185 / FAX: +420-59-5691-199

#### **Russia Service Center**

#### **MITSUBISHI ELECTRIC RUSSIA LLC**

LETNIKOVSKAYA STREET 2, BLD.1, 5TH 115114 MOSCOW, RUSSIA  
TEL: +7-495-721-2070 / FAX: +7-495-721-2071

#### **Sweden Service Center**

HAMMARBACKEN 14, P.O.BOX 750 SE-19127, SOLLENTUNA, SWEDEN  
TEL: +46-8-6251200 / FAX: +46-8-6251014

#### **Bulgaria Service Center**

#### **AKHNATON Ltd. (Service Partner)**

4 ANDREJ L.JAPCHEV BLVD. POB 21, BG-1756 SOFIA, BULGARIA  
TEL: +359-2-8176009 / FAX: +359-2-9744061

#### **Ukraine Service Center (Kiev)**

#### **CSC Automation Ltd. (Service Partner)**

4 B, YEVHENA SVERSTYUKA STR., 02002 KIEV, UKRAINE  
TEL: +380-44-494-3344 / FAX: +380-44-494-3366

#### **Belarus Service Center**

#### **TECHNIKON Ltd. (Service Partner)**

NEZAVISIMOSTI PR.177, 220125 MINSK, BELARUS  
TEL: +375-17-393-1177 / FAX: +375-17-393-0081

#### **South Africa Service Center**

#### **Adroit Technologies (Service Partner)**

20 WATERFORD OFFICE PARK, WATERFORD DRIVE, CNR OF WITKOPPEN ROAD,  
FOURWAYS JOHANNESBURG SOUTH AFRICA  
TEL: +27-11-658-8100 / FAX: +27-11- 658-8101

**ASEAN****MITSUBISHI ELECTRIC ASIA PTE. LTD. (ASEAN FA CENTER)**

Singapore Service Center  
307 ALEXANDRA ROAD #05-01/02 MITSUBISHI ELECTRIC BUILDING SINGAPORE 159943  
TEL: +65-6473-2308 / FAX: +65-6476-7439

**PHILIPPINES****MELCO FACTORY AUTOMATION PHILIPPINES INC.**

Head Office  
128 LOPEZ RIZAL STREET, BRGY., HIGHWAY HILLS, MANDALUYONG CITY, MM PHILIPPINES 1550  
TEL: +63-2-8256-8042 / FAX: +632-8637-2294

Philippines Service Center  
KM.23 WEST SERVICE ROAD SSH, CUPANG, MUNTINLUPA CITY, PHILIPPINES  
TEL: +63-2-8807-0420 / FAX: +63-2-8842-5202

**VIETNAM****MITSUBISHI ELECTRIC VIETNAM CO., LTD.**

Vietnam Ho Chi Minh Service Center  
11TH & 12TH FLOOR, VIETTEL TOWER B, 285 CACH MANG THANG 8 STREET, WARD 12, DISTRICT 10,  
HO CHI MINH CITY, VIETNAM  
TEL: +84-28-3910 5945 / FAX: +84-28-3910 5947

Vietnam Hanoi Service Center  
24TH FLOOR, HANDICO TOWER, PHAM HUNG ROAD, ME TRI HA, ME TRI WARD,  
NAM TU LIEM DISTRICT, HA NOI CITY, VIETNAM  
TEL: +84-24-3937-8075 / FAX: +84-24-3937-8076

**INDONESIA****PT. MITSUBISHI ELECTRIC INDONESIA**

Indonesia Service Center (Cikarang)  
JL. KENARI RAYA BLOK G2-07A, DELTA SILICON 5, LIPPO CIKARANG - BEKASI 17550, INDONESIA  
TEL: +62-21-2961-7797 / FAX: +62-21-2961-7794

**MALAYSIA****MITSUBISHI ELECTRIC SALES MALAYSIA SDN. BHD.**

Malaysia Service Center (Kuala Lumpur Service Center)  
LOT 11, JALAN 219, P.O BOX 1036, 46860 PETALING JAYA, SELANGOR DARUL EHSAN, MALAYSIA  
Tel: +60-3-7626-5032 / FAX: +60-3-7960-2629  
Johor Bahru Service Satellite  
Pulau Pinang Service Satellite

**THAILAND****MITSUBISHI ELECTRIC FACTORY AUTOMATION (THAILAND) CO., LTD.**

Thailand Service Center (Bangkok)  
101, TRUE DIGITAL PARK OFFICE, 5TH FLOOR, SUKHUMVIT ROAD, BANGCHAK, PHRAKHANONG,  
BANGKOK, 10260 THAILAND  
TEL: +66-2-092-8600 / FAX: +66-2-043-1231-33

**INDIA****MITSUBISHI ELECTRIC INDIA PVT., LTD.**

CNC Technical Center (Bangalore)  
PLOT NO. 56, 4TH MAIN ROAD, PEENYA PHASE 3,  
PEENYA INDUSTRIAL AREA, BANGALORE 560058, KARNATAKA, INDIA  
TEL : +91-80-4655-2121 / FAX : +91-80-4655-2147  
Chennai Service Satellite  
Coimbatore Service Satellite  
Hyderabad Service Satellite

North India Service Center (Gurgaon)  
PLOT 517, GROUND FLOOR, UDYOG VIHAR PHASE-III, GURUGRAM 122008, HARYANA, INDIA  
TEL : +91-124-463-0300 / FAX : +91-124-463-0399  
Ludhiana Service Satellite  
Panthnagar Service Satellite  
Delhi Service Satellite  
Jamshedpur Service Satellite  
Manesar Service Satellite

West India Service Center (Pune)  
ICC-Devi GAURAV TECHNOLOGY PARK, UNIT NO.402, FOURTH FLOOR, NORTH WING,  
SURVEY NUMBER 191-192 (P), NEXT to INDIAN CARD CLOTHING COMPANY Ltd,  
OPP. VALLABH NAGAR, PIMPRI, PUNE- 411 018, MAHARASHTRA, INDIA  
TEL : +91-20-6819 2274 / FAX : +91-20-4624 2100  
Kolhapur Service Satellite  
Aurangabad Service Satellite  
Mumbai Service Satellite

West India Service Center (Ahmedabad)  
204-209, 2ND FLOOR, 31FIVE, CORPORATE ROAD PRAHLADNAGAR,  
AHMEDABAD -380015, GUJARAT, INDIA  
TEL : + 91-79-6777 7888  
Rajkot Service Satellite

**CHINA****MITSUBISHI ELECTRIC AUTOMATION (CHINA) LTD. (CHINA FA CENTER)**

CNC Call Center  
TEL: +86-400-921-5130

Shanghai Service Center  
1-3,5-10,18-23/F, NO.1386 HONG QIAO ROAD, CHANG NING QU,  
SHANGHAI 200336, CHINA  
TEL: +86-21-2322-3030 / FAX: +86-21-2322-3000\*8422

Qingdao Service Center  
Suzhou Service Center  
Wuhan Service Center  
Ningbo Service Center  
Hefei Service Center  
Beijing Service Center  
Tianjin Service Center  
Xian Service Center  
Dalian Service Center  
Chengdu Service Center

Shenzhen Service Center  
LEVEL8, GALAXY WORLD TOWER B, 1 YABAO ROAD, LONGGANG DISTRICT,  
SHENZHEN 518129, CHINA  
TEL: +86-755-2399-8272 / FAX: +86-755-8229-3686

Dongguan Service Center  
Xiamen Service Center

**KOREA****MITSUBISHI ELECTRIC AUTOMATION KOREA CO., LTD. (KOREA FA CENTER)**

Korea Service Center  
8F GANGSEO HANGANG XI-TOWER A, 401 YANGCHEON-RO, GANGSEO-GU,  
SEOUL 07528 KOREA  
TEL: +82-2-3660-9631 / FAX: +82-2-3664-8668  
Korea Daegu Service Satellite

**TAIWAN****MITSUBISHI ELECTRIC TAIWAN CO., LTD. (TAIWAN FA CENTER)**

Taiwan Taichung Service Center  
NO. 8-1, GONGYEQU 16th RD., XITUN DIST., TAICHUNG CITY 40768, TAIWAN  
TEL: +886-4-2359-0688 / FAX: +886-4-2359-0689

Taiwan Taipei Service Center  
11F, NO.88, SEC.6, ZHONGSHAN N. RD., SHILIN DIST., TAIPEI CITY 11155, TAIWAN  
TEL: +886-2-2833-5430 / FAX: +886-2-2833-5433

Taiwan Tainan Service Center  
11F.-1, NO.30, ZHONGZHENG S. RD., YONGKANG DIST., TAINAN CITY 71067, TAIWAN  
TEL: +886-6-252-5030 / FAX: +886-6-252-5031

**OCEANIA****MITSUBISHI ELECTRIC AUSTRALIA PTY. LTD.**

Oceania Service Center  
348 VICTORIA ROAD, RYDALMERE, N.S.W. 2116 AUSTRALIA  
TEL: +61-2-9684-7269/ FAX: +61-2-9684-7245

**Notice**

Every effort has been made to keep up with software and hardware revisions in the contents described in this manual. However, please understand that in some unavoidable cases simultaneous revision is not possible.

Please contact your Mitsubishi Electric dealer with any questions or comments regarding the use of this product.

**Duplication Prohibited**

This manual may not be reproduced in any form, in part or in whole, without written permission from Mitsubishi Electric Corporation.

COPYRIGHT 2019-2022 MITSUBISHI ELECTRIC CORPORATION  
ALL RIGHTS RESERVED

# MITSUBISHI ELECTRIC CORPORATION

HEAD OFFICE : TOKYO BLDG.,2-7-3 MARUNOUCHI,CHIYODA-KU,TOKYO 100-8310,JAPAN

---

MODEL	C80 Series
MODEL CODE	100-697
Manual No.	IB-1501560